

# DESIGN CONTEXT

# 2

DESIGN INFORMATION BOOKLET NUMBER TWO

JULY 1989

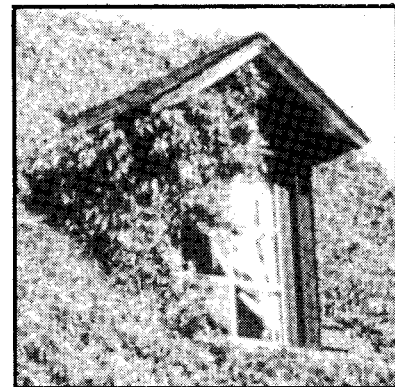
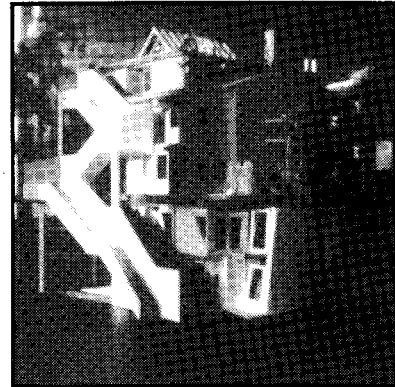
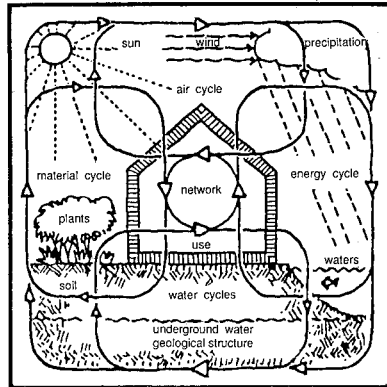
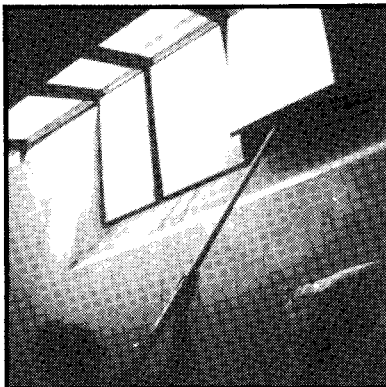
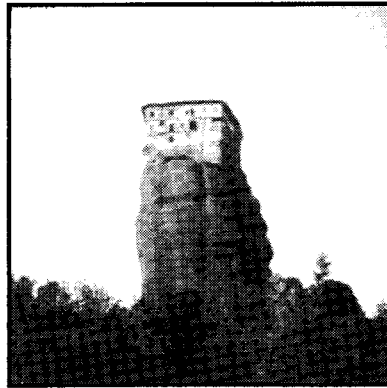
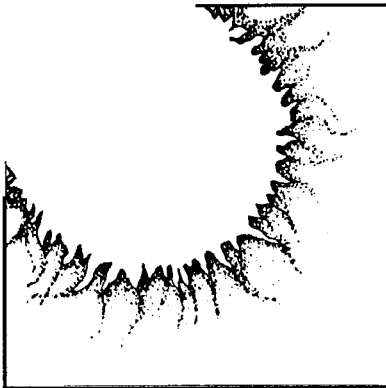

## NOTICE:

This report was prepared as an account of work sponsored by the German Federal Ministry of Research and Technology for the International Energy Agency. Neither the German Government nor the International Energy Agency, nor any of their employees, nor any of their contractors, subcontractors, or their employees makes any warranty, expressed or implied, or assumes any legal liability or responsibility for the accuracy, completeness or usefulness of any information, apparatus, product or process disclosed, or represents that its use would not infringe privately owned rights.

REPORT NO. IEA SHAC T.8.C.2

PASSIVE AND HYBRID SOLAR LOW ENERGY BUILDINGS

# DESIGN CONTEXT

# 2

DESIGN INFORMATION BOOKLET NUMBER TWO

JULY 1989

Institut für Bau-, Umwelt - und Solarforschung GmbH  
Prof. H.Schreck, G.Hillmann, J.Nagel  
Caspar-Theyss-Strasse 14A  
D-1000 Berlin 33, F.R. of Germany

Günter Löhnert  
Hans-Martin Schmid

INTERNATIONAL ENERGY AGENCY: SOLAR HEATING AND COOLING PROGRAM, TASK VIII

# FOREWORD

---

The International Energy Agency (IEA), headquartered in Paris, France, was formed in November 1974 to establish cooperation among a number of industrialized countries in the vital area of energy policy. It is an autonomous body within the framework of the Organization for Economic Cooperation and Development. Twenty-one countries are presently members, with the Commission of the European Communities participating under a special arrangement.

One element of the IEA's program involves cooperation in the research and development of alternative energy resources in order to reduce excessive dependence on oil. A number of new and improved energy technologies that have the potential of making significant contributions to global energy needs were identified for collaborative efforts. Solar heating and cooling was one of the technologies selected for joint activities. Cooperative research is conducted under terms of a formal Implementing Agreement signed by the participating countries. One of the collaborative projects, Task VIII, concerns passive and hybrid solar, low energy buildings.

The goal of Task VIII is to accelerate the technical understanding and marketplace availability of energy efficient, passive solar homes. Fourteen countries have participated in the research - Austria, Belgium, Canada, Denmark, Federal Republic of Germany, Italy, Netherlands, New Zealand, Norway, Spain, Switzerland, Sweden, United Kingdom and United States.

The knowledge gained during this collaboration has been assembled in a series of eight booklets. The Design Information Booklets in the series are listed and described on the opposite page. Information on purchasing these booklets can be obtained by contacting the following organizations or by ordering directly from the U.S. Government Printing Office:

## **Austria**

Osterreichisches  
Forschungszentrum Seibersdorf  
A - 2444 Seibersdorf

## **Germany**

Projektleitung Biologie, Ökologie  
und Energie  
KFA Jülich  
Postfach 1913  
D - 5170 Jülich

## **Norway**

A/S Miljøplan  
Kjorboveien 23  
N - 1300 Sandvika

## **United Kingdom**

Renewable Energy Enquiries  
Bureau  
Energy Technology Support Unit  
Harwell Laboratory, Building 156  
Oxfordshire OX 11 0RA

## **Belgium**

Science Policy Office  
Rue de la Science 8  
B - 1040 Brussels

## **Italy**

Consiglio Nazionale Ricerche  
Progetto Finalizzato Energetica  
Via Nizza 128  
I - 00198 Roma

## **Spain**

IER - CIEMAT  
Avda Complutense 22  
28040 Madrid

## **United States**

Technical Inquiry Service  
Solar Energy Research Institute  
1617 Cole Boulevard  
Golden, Colorado 80401

## **Canada**

Solar Energy Development  
Program  
Energy, Mines and Resources  
460 O'Connor Street  
Ottawa, Ontario K1A 0E4

## **Netherlands**

Management Office for Energy  
Research (PEO)  
P.O. Box 8242  
NL - 3503 - RE Utrecht

## **Sweden**

Svensk Byggtjänst,  
Litteratutjänst  
Box 7853,  
103 99 Stockholm

## **Other**

Superintendent of Documents  
U.S. Government Printing Office  
Washington, D.C. 20402-9372

## **Denmark**

Thermal Insulation Laboratory  
Technical University of Denmark  
Building 118  
DK - 2800 Lyngby

## **New Zealand**

School of Architecture  
Victoria University of Wellington  
Private Bag  
Wellington 1

## **Switzerland**

Federal Office of Energy  
CH - 3003 Berne

The U.S. Department of Energy (DOE) is the Operating Agent of IEA Task VIII: Passive and Hybrid Solar Low Energy Buildings. Michael J. Holtz of Architectural Energy Corporation, Boulder, Colorado, serves as Task Chairman on DOE's behalf.

# DESIGN INFORMATION BOOKLET SERIES

---

## **Booklet No. 1 Energy Design Principles in Buildings**

This Booklet is essentially a primer of heat transfer in buildings. Fundamental heat transfer concepts and terminology are defined, followed by a discussion of heating and cooling strategies and principles for passive and hybrid solar buildings. It is written in non-technical language for the designer or builder not familiar with general heat transfer principles in buildings.

## **Booklet No. 2 Design Context**

Booklet number 2 defines, in a checklist format, the issues that are unique to energy conserving, passive solar design that must be considered early in the design process. Issues discussed include site and climate analysis, building organization and design, building system options, space conditioning options, user influence and building codes and zoning ordinances.

## **Booklet No. 3 Design Guidelines: An International Summary**

Passive solar and energy conservation design guidelines have been developed by each participating country. These guidelines are presented in national design guidelines booklets. Booklet number 3, Design Guidelines: An International Summary, summarizes the major findings and patterns of performance observed from the national passive solar and energy conservation guidelines.

## **Booklet No. 4 Design Tool Selection And Use**

This Booklet addresses the characteristics desirable in a design tool and a means to select one or more for use. The selection process is organized around the design process; what design questions are being addressed, what information is available, what output or result from a design tool for which one is looking. A checklist is provided to assist in design tool selection. The use of benchmark test cases developed from detailed building energy analysis simulations is presented as a means to evaluate simplified design tools.

## **Booklet No. 5 Construction Issues**

Construction problems unique to the use of passive and hybrid solar features are defined in this booklet as well as several proven solutions. Due to the unique construction technology in each country, representative construction details are provided. The intent is to define where construction detailing is crucial to the performance of low energy, passive solar homes and provide some ideas on how these detailing problems can be solved for a range of construction technology.

## **Booklet No. 6 Passive Solar Homes: Case Studies**

This Booklet describes the passive and hybrid solar houses designed, constructed and monitored under the IEA Task VIII project, as a means of showing the architectural impact of energy conservation and passive/ hybrid solar features. This booklet reinforces the idea that good energy design is also good architecture and is cost effective. Each of the passive solar houses is presented as a case study on the design, construction and performance results.

## **Booklet No. 7 Design Language**

Booklet number 7 is aimed at designers, architects and educators. It defines an approach to generating whole building solutions based on climate analysis and design context analysis. It also addresses architectural typologies based on climatic/energy principles. This booklet forms a general, universal companion to Booklet Number 3, Design Guidelines.

## **Booklet No. 8 Post Construction Activities**

Post Construction Activities defines issues to be considered once the project is constructed and occupied. It addresses those elements of the passive solar building that are unique and may require special attention by the occupants. Performance evaluation of the home in terms of energy performance, comfort and occupant satisfaction is also addressed as a means of providing information back to the designer on how well the project is performing.

# **ACKNOWLEDGEMENTS**

---

This report was made possible through the support of the German Federal Ministry of Research and Technology. The authors wish to acknowledge the helpful comments and suggestions provided by the Subtask C participants and the authors of other Booklets in the Design Information Booklet series including A. Minne, M. Holtz, D. Anderson, H. Kok, S. Los and S. Blum. Also gratefully acknowledged is the editorial and production assistance of the Operating Agent, Michael Holtz, and Chris Mack and Tracy Ashleigh, all of Architectural Energy Corporation.

# CONTENTS

---

	page
<b>INTRODUCTION</b>	<b>1</b>
<b>HOW TO USE THIS BOOKLET</b>	<b>3</b>
<b>1.0 SITE ANALYSIS</b>	<b>5</b>
Checklist	6
1.1 Macro-and Meso-Climatic Features	7
1.2 Regional and Local Climatic Features	10
1.3 Urban and Micro-Climatic Features	12
1.4 What is Your Climate ?	16
1.5 Bioclimatic Checklist	19
<b>2.0 BUILDING ORGANIZATION</b>	<b>29</b>
Checklist	30
2.1 Surface Area and Volume	31
2.2 Relation to Sun	33
2.3 Relation to Wind	36
2.4 Relation to Topography	38
2.5 Relation to Vegetation	40
2.6 Zoning Principle	43
2.7 Buffer Space Effect	47
<b>3.0 BUILDING SYSTEM OPTIONS</b>	<b>49</b>
Checklist	50
3.1 Building Structure and Thermal Mass	51
3.2 Insulation	54
3.3 Glazing	57
3.4 Shading	61

# CONTENTS

---

	page
<b>3.5 Passive / Hybrid Solar Heating Systems:</b>	<b>63</b>
• Direct Gain	64
• Thermal Storage Wall	66
• Air Collector	68
• Sunspace	70
<b>3.6 Passive Cooling</b>	<b>76</b>
<b>4.0 AUXILIARY SPACE CONDITIONING</b>	<b>89</b>
Checklist	90
<b>4.1 Thermal Comfort</b>	<b>92</b>
<b>4.2 Internal Gains</b>	<b>97</b>
<b>4.3 Selection of Auxiliary Heating Concepts</b>	<b>98</b>
<b>4.4 Auxiliary Heating Systems</b>	<b>101</b>
<b>4.5 Active Solar Systems</b>	<b>115</b>
<b>5.0 USER INFLUENCE</b>	<b>117</b>
Checklist	118
<b>5.1 Users Impact on Energy Performance</b>	<b>119</b>
<b>5.2 Determinants of Users Acceptance</b>	<b>120</b>
<b>5.3 Users Acceptance of Certain Systems and Components</b>	<b>124</b>
<b>6.0 BUILDING CODES AND REGULATIONS</b>	<b>133</b>
Checklist	134
<b>6.1 Zoning Regulations</b>	<b>135</b>
<b>6.2 Building Codes and Industry Standards</b>	<b>139</b>
<b>CONCLUSION</b>	<b>146</b>
<b>REFERENCES</b>	<b>147</b>



# INTRODUCTION

Consideration of energy consumption and of the outdoor environment during the architectural design process is necessary due to rising energy demand, increasing loads on the natural environment, and limited fossil fuel supplies. Therefore, energy and environmental factors must be considered in all facets of planning: regional, urban, and building design.

The goals of bioclimatic design are as follows:

- Minimize energy demand and environmental impact
- Maximize use of renewable forms of energy
- Optimize total energy and auxiliary space conditioning systems

The management of environmental influences requires an adequate evaluation of bioclimatic impacts whether they are an energetic asset or a liability for the individual design. As this may vary according to the individual task and scale of design, it is necessary to identify potential conflicts and contradictions of technical, environmental, and economic conditions. These bioclimatic strategies should be targeted and incorporated to a maximum extent for each design. Aside from energy-related aspects, the architectural development should also promote the use of environmentally sensitive building products to improve both the relief of nature and the living quality for the occupants.

The goal of the booklet is to identify the most relevant issues of energy, architecture, and natural environment and to discuss the related interdependencies.

**Figure 1**  
Thermal interactions of physical bodies with their environment

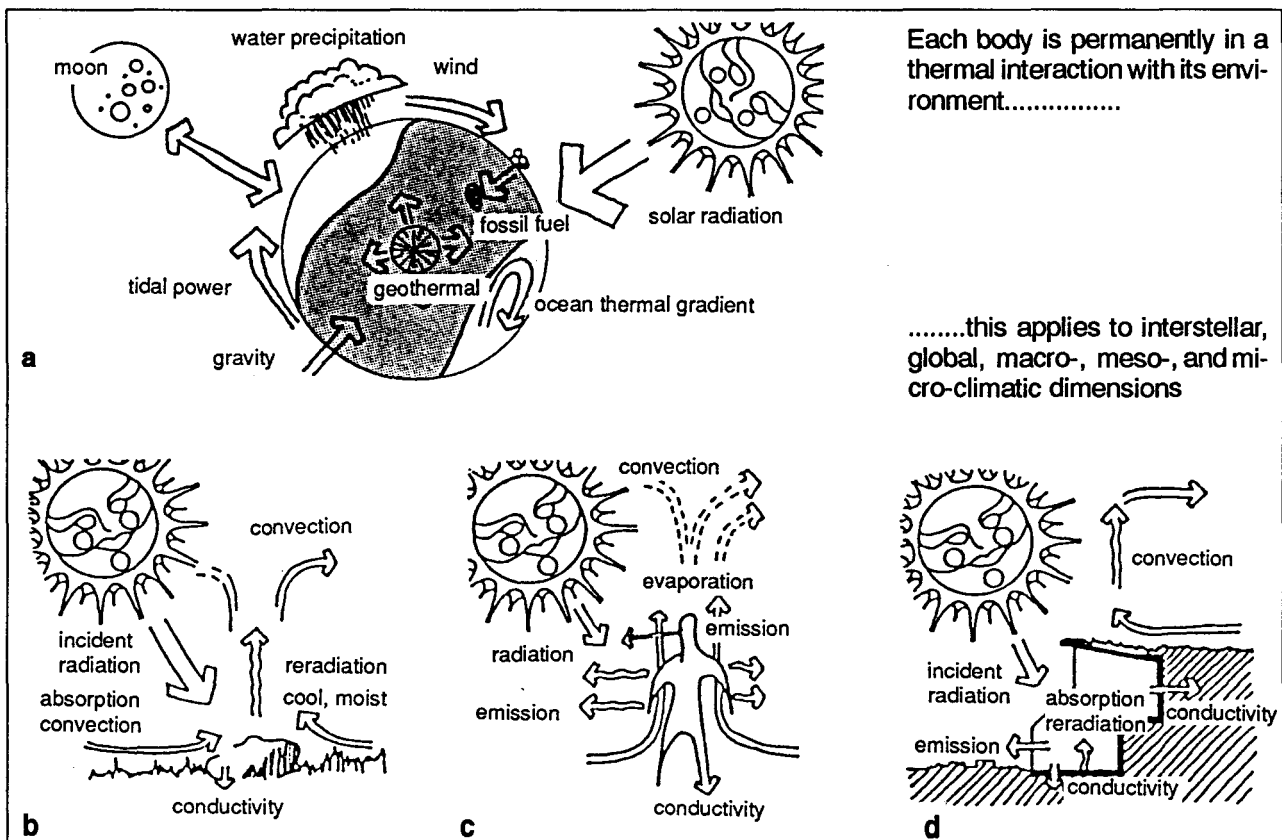

# INTRODUCTION

## Conventional Building Design

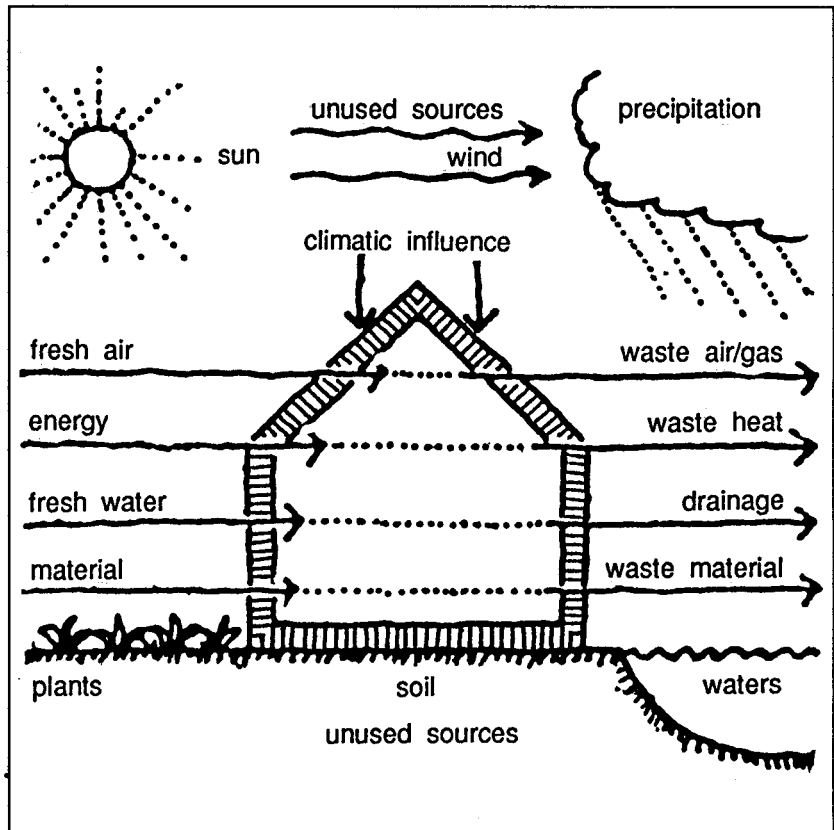

**Figure 2**  
Conventional buildings do not effectively use the resources of their natural environment, but use energy and material and produce waste. Houses like these create costs and environmental problems by necessitating extensive supply and disposal facilities.

## Bioclimatic Building Design

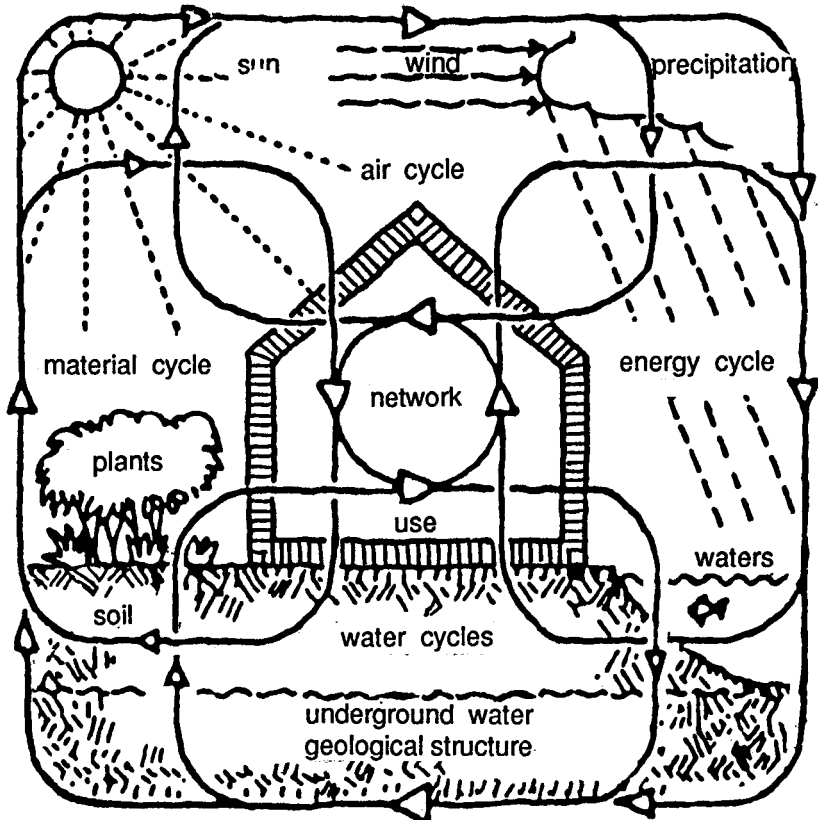

**Figure 3**  
A bioclimatic building is completely integrated into the cycles of nature and is able to use them without causing damage. The interactions of the main cycles concerning the basic elements of soil, water, energy, and air should carefully be considered and transferred into the design of buildings and residential developments.

# HOW TO USE THE BOOKLET

**Design Context** identifies energy-related design factors that the designer should be aware of at the beginning of the design process. These factors are organized into six categories and represent the type of program information needed by a designer to develop a bioclimatic design.

Each category corresponds to a booklet chapter. A checklist is presented as the introduction to each chapter, followed by brief explanatory notes and figures on the checklist items. Though the booklet is not a real looseleaf notebook, it has been designed to accept additional information about each category and checklist item pertaining to local conditions, materials, products, and regulations. If actively used, the booklet can become a repository for energy-related design information, consolidating and organizing helpful information obtained from technical journals, conferences, and product literature.

The intended procedure for using the booklet is that, during the architectural program phase, the checklists would be reviewed by the project designer for factors relevant to the current project. Information needed for preparing the project program document would be obtained from explanatory notes and figures, other data included in the booklet, or information sources suggested in the booklet. The goal is to help the project designer collect and organize energy-related design information for the purpose of developing an architectural program responsive to bioclimatic design issues. Chapter checklists are not a list of contents in particular. Rather, these checklists represent an array of relevant issues which are touched upon in a more or less detailed manner by the booklet itself or by references to other booklets in this Design Information Booklet Series.

Figure 4  
Correlating Booklet Chapters

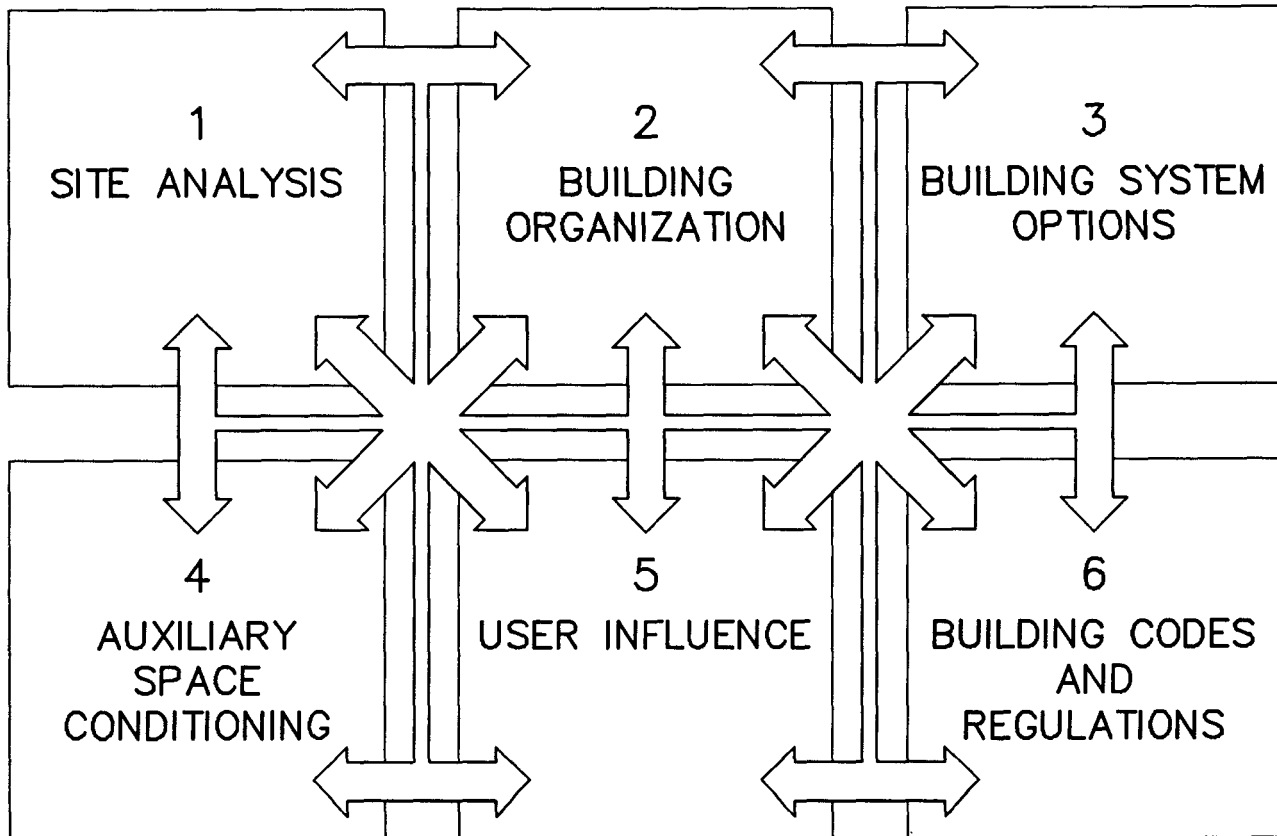

## HOW TO USE THE BOOKLET

---

**Design Context** is not a formula for Bioclimatic Architecture because there are no true general recipes to cover this scope of issues. Each climate requires different solutions; each country is characterized by its regional and local environmental conditions and cultural traditions; and each nation defines its own legal context supporting or restricting bioclimatic design approaches.

This contribution rather should be viewed as a structural platform: the user of the Booklet should apply the information contained herein to the specific local conditions.

Great importance has been attached to the accentuated graphic - like format of this Booklet which we hope will be appreciated by the expected audience of planners and architects.

Evaluation of the project site is one of the most important steps in bioclimatic design. It is generally not possible to choose a site location according to its bioclimatic potential. Thus, the designer has to consider the advantages and disadvantages of existing environmental factors because these will ultimately define the living quality of the site.

Housing and climatic conditions are interrelated: climate influences housing forms, and building structures create microclimatic conditions. The term "energy conscious design" means to consider, to respect and to integrate this natural relationship into "modern" design, and to comply with certain climatic premises through appropriate decisions concerning the building structure, its material and its space conditioning demands.

Mechanical systems are designed to heat and cool a building when outdoor climatic conditions make indoor spaces uncomfortable. One of the most effective ways of saving energy is a strategy of energy conservation and passive design which involves opening the interior to the advantages of the local climatic environment for natural conditioning. This will reduce the dependence on mechanical systems.

The first section of this chapter addresses the bioclimatic elements which characterize the particular conditions of each site. Important issues of climatic, environmental, architectural issues, and interdependence are discussed to promote the designer's awareness of the bioclimate.

A bioclimatic checklist summarizes and focuses the potentially relevant issues which could and should be considered during the design process.

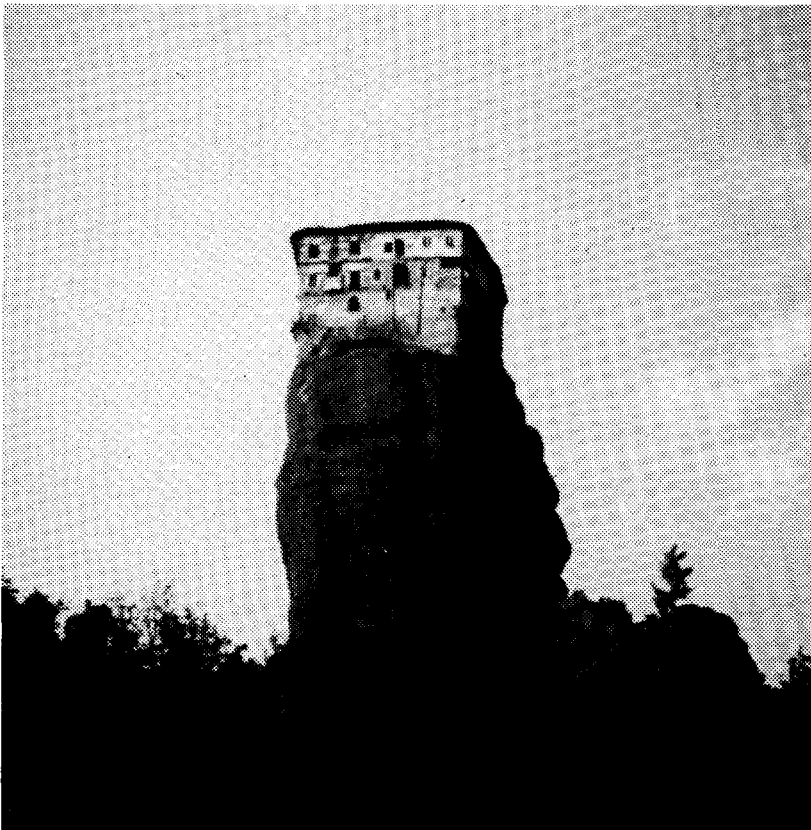

*Figure 1.0*

Bioclimatic evaluation of a building site is not exclusively a question of solar exploitation potential for the building itself. The design of a residence has to consider various interdependencies of its natural and its physical environment.

# SITE ANALYSIS

---

## Checklist

### **SITE ANALYSIS:**

Analyze the site according to the environmental conditions relating to:

#### **Climate**

- Obtain temperature, cloudiness, humidity, and rainfall data from the nearest meteorological station
- Characterize general climate conditions by plotting climate data on psychrometric chart
- Assess features in and around site that will influence microclimate

#### **Topography**

Assess site topographic and geologic conditions relative to:

- Slope and orientation
- Soil type
- Contours
- Solar access
- Drainage paths

#### **Vegetation**

Assess site vegetation relative to:

- Species and location
- Shading potential
- Wind blockage potential
- Snowdrift formation potential
- Privacy
- Solar access
- Views

#### **Architecture**

- Height, shape and style of surrounding buildings
- Material usage and construction details of surrounding buildings

#### **Urban Context**

- Scale, density and potential use of surrounding land and buildings
- Vehicular and pedestrian paths and access
- Air quality, pollution sources
- Zoning

# SITE ANALYSIS

Many different climate-classification schemes have been developed for different purposes. Concerning climatic influences on architectural and building design, it is suitable to distinguish four different macro-scale climates. These are based on temperature and humidity, which are the primary determinants of human comfort.

## 1.1 Macro- and Meso-Climatic Features

- 1) Cold climates are characterized by long periods of cold temperature. Annual minimum temperatures may reach minus 40 °C; mean maximum temperatures in winter may even stay below 0 °C.
- 2) Temperate climates have seasonal temperature variations of too warm in summer and too cold in winter. Seasonal mean temperature swings range between minimum -15 °C and maximum 35 °C. Average temperatures of 20 °C are rarely accompanied by relative humidities greater than 80%. Precipitation is distributed in each season depending on temperature and humidity, rain, fog or snow in winter.
- 3) Hot and dry climates are characterized by high temperatures and low humidity. Average temperatures in summer are above 25 °C. Diurnal temperature fluctuations are wide because of high radiant emission to the clear sky at night. Annual temperature variations may reach 50 K. Strong winds carrying sand and dust unrestricted by vegetation characterize these desert climates.
- 4) Hot and humid climates are characterized by high temperatures and high humidity. Annual mean temperatures are above 20 °C with mean values of relative humidity around 80%. Intensive periods of rainfall result in annual precipitation of 2000 mm and more.

*Figure 1.1*  
Global macro-climate distribution of cold, temperate, hot-dry, and hot-humid areas.

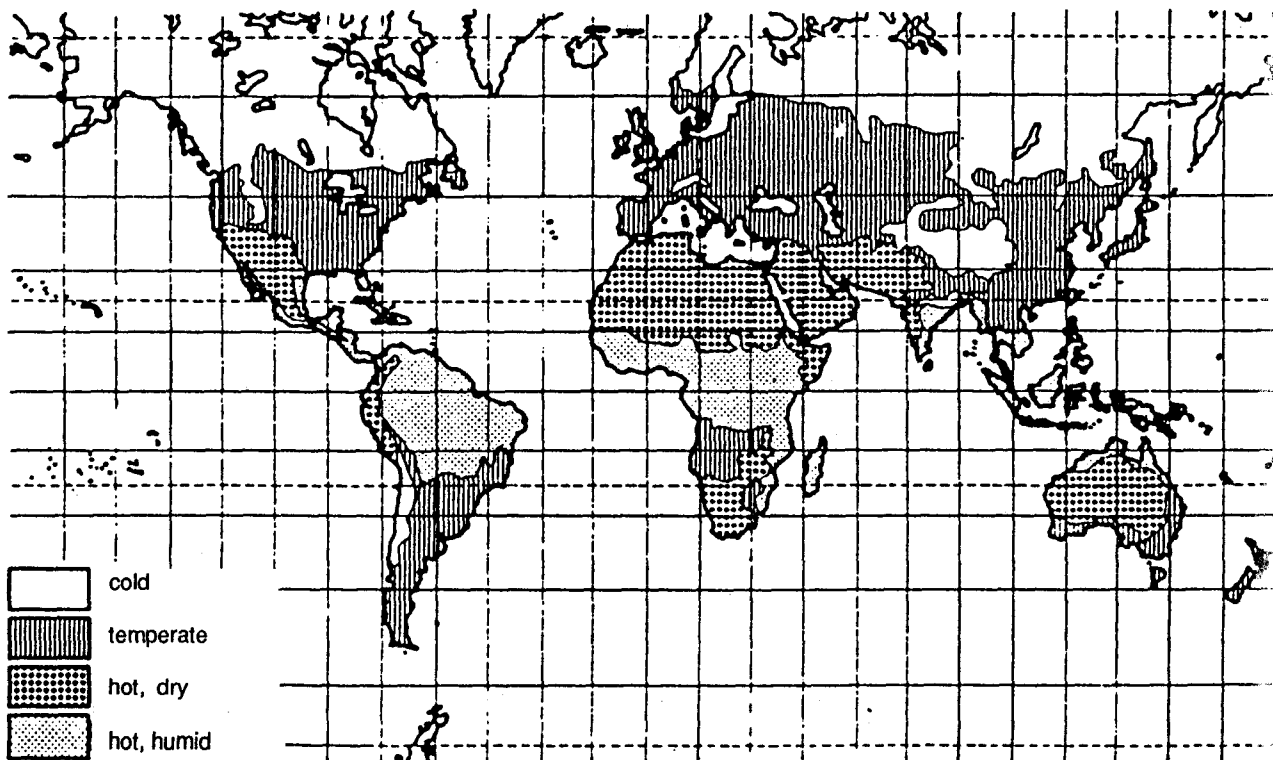

# SITE ANALYSIS

Characteristics of four climates:

- 1 **Solar radiation (kWh/m<sup>2</sup>day):**  
Monthly mean values of solar radiation availability are a quantified indication of the potential of solar energy systems.
- 2 **Sunshine hours:**  
The average amount of sunshine hours per month give a rough qualitative assumption for solar system options. Sunshine hours consider only direct solar radiation suitable for a comparison of different locations. They are not sufficient for calculating solar gains or system efficiency.
- 3 **Air temperature (°C):**  
The upper and lower graph show the values of maximum and minimum extreme temperature. To evaluate the heating demand, the maximum and minimum mean values are also indicated which are necessary to calculate the degree days for a certain climate.

## COLD

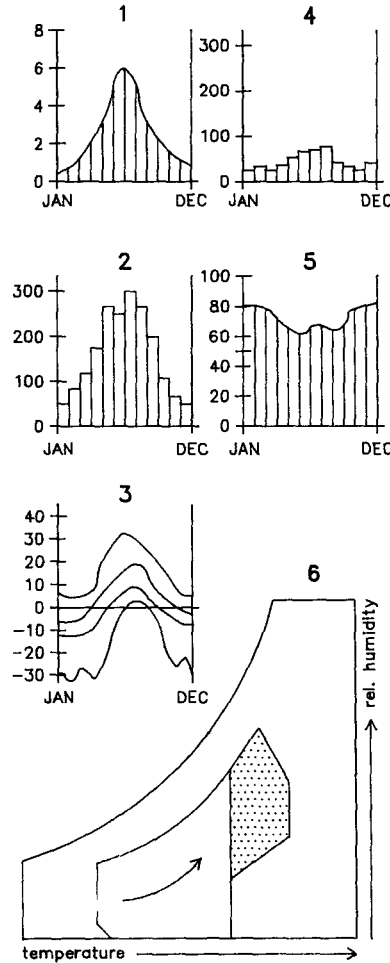

## TEMPERATE

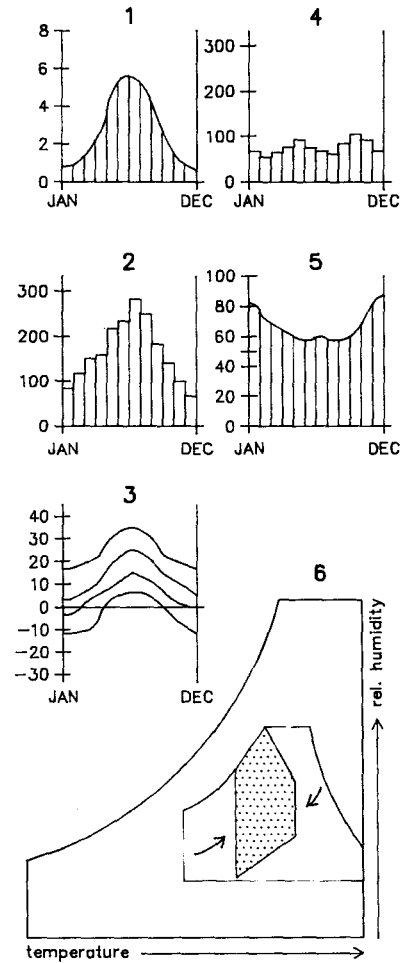

### Energy Design Requirements

- insulation
- wind protection
- spacial zoning
- facing sun
- mechanical conditioning

- insulation
- heat storage
- wind protection
- spacial zoning
- facing sun
- natural ventilation
- rain protection
- sun protection
- evaporation
- mechanical conditioning

### Bioclimatic Features of Vernacular Architecture

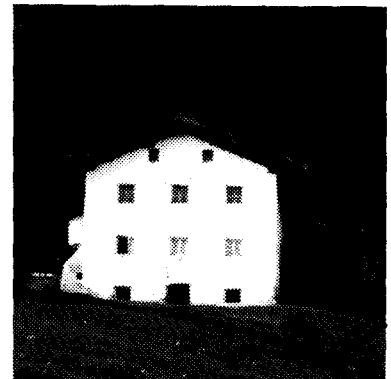



# SITE ANALYSIS

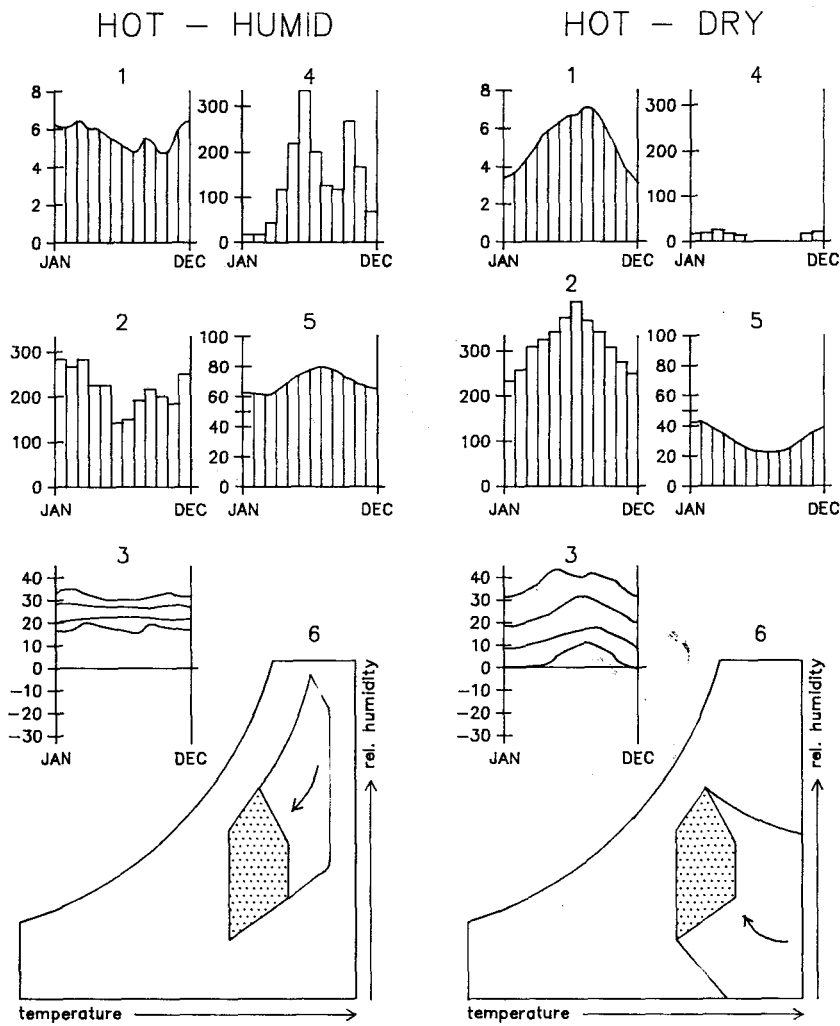

- 4 **Precipitation (mm):**  
Monthly precipitation values include rainfall and snowfall. The amount of each fraction depends on altitude, topography, and wind direction.
- 5 **Relative humidity (%):**  
Humidity must be considered in concert with temperature. Both climatic elements form the basis for determining physical human comfort in a psychrometric chart.
- 6 **Psychrometric chart:**  
A psychrometric chart should be developed for each climate (see pages 16 and 17). It plots climatic conditions related to the thermal comfort zone and defines means to improve comfort for climatic conditions outside of the comfort zone.

- spacial zoning
- natural ventilation
- rain protection
- sun protection
- mechanical conditioning

- heat storage
- spacial zoning
- natural ventilation
- sun protection
- evaporation

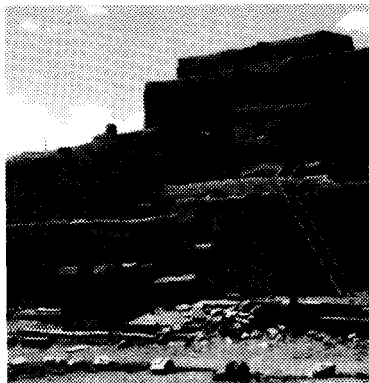

**Figure 1.2**  
Different climates require different architectural solutions. In fact, the hierarchy of the measures are defined by a more specific consideration of climatic scales.

# SITE ANALYSIS

## 1.2 Regional and Local Climatic Features

Most of the earth's population is distributed within the temperate climatic zone. The distinction between the global climatic zones of cold, temperate, hot-dry, and hot-humid (see pages 7-9) is drawn on the basis of temperature and humidity. These are the two climatic elements which are most responsible for evaluation of human comfort (see psychrometric chart, page 16).

Although this categorization into just four climatic zones suffices for general design guidelines, in order to come closer to actual climatic assessments, it is necessary to consider more specific climatic zones on a regional and local scale. For example, the European climate can be divided into more specific climate zones, as shown in Figure 1.3. Boundaries between the different zones are affected by topographical features, latitude, altitudes, wind systems, ocean currents, and proximity to water. The two most relevant isotherms of January 0 °C and July 20 °C create the Middle European climate (an isotherm is a line connecting geographic areas which have the same average temperature at a particular time of year).

For the building design level, however, more information is necessary to evaluate how climate is affected by geography and topography of a certain site and its surroundings, and how it could be further influenced by building location and landscape features. The climatic environment in which a building must operate is defined by the specific site conditions of temperature and humidity levels, wind, and sunshine. These factors are characterized by certain seasonal and daily variations which can be a liability or an asset for building energy performance.

**Figure 1.3**  
Rough characterisation of European Climates.

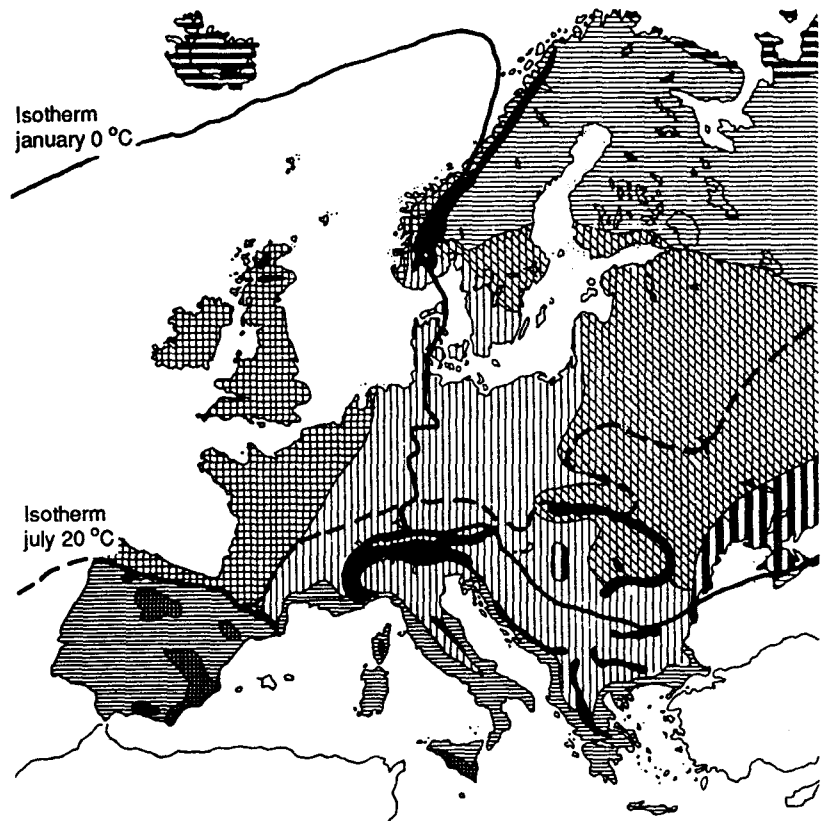
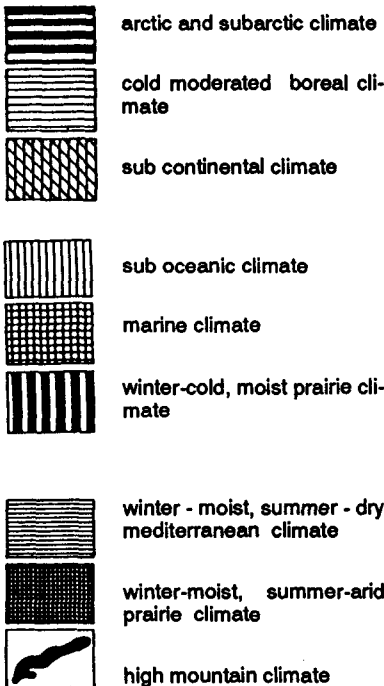

# SITE ANALYSIS

The presence of mountains and hills results in different microclimatic conditions through the mixing of shaded and solar exposed surfaces. Variations of air flow depend on daily solar radiation; main regional wind direction and velocity may increase or decrease the strength of those thermally dynamic patterns, shown in Figure 1.5. A solar-driven wind pattern is common in temperate climates and during sunny periods elsewhere. For more diffuse solar irradiation conditions, however, this effect is less significant.

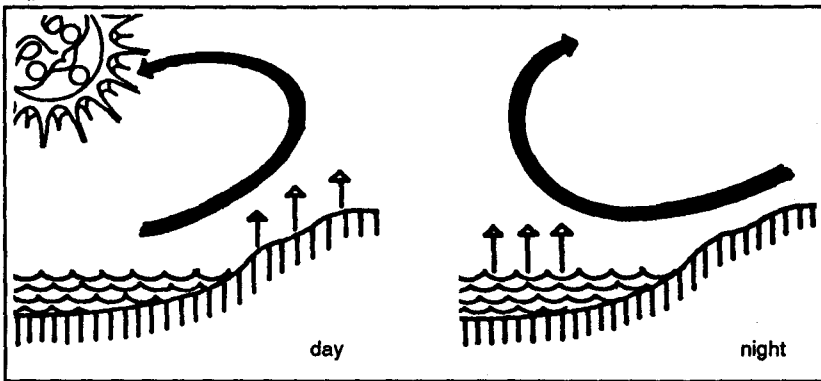

**Figure 1.4**  
Air flow patterns influenced by proximity to large water surfaces.

**Daytime:**

Soil warms up more quickly than water, which effects a wind movement from the water.

**Nighttime:**

The inverse process occurs when warm air rises from the water, which stores heat much longer than does soil.

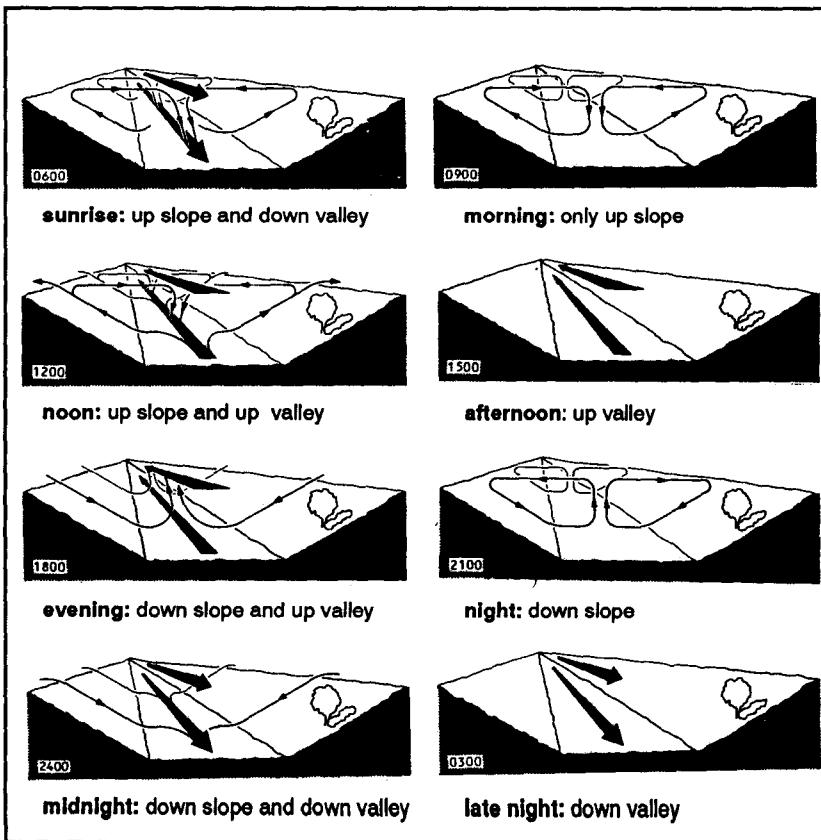

**Figure 1.5**  
Small-scale wind movements in a valley on a calm sunny day:

During a 24-hour period different patterns of air movement will occur, depending on the exposure of surfaces to the sun and the temperature gradient of daytime and nighttime.

Alternating air movements up and down the slopes and the valley interact according to temperature variations.

These schematic patterns may be diminished or fortified by local prevailing wind systems.

# SITE ANALYSIS

Figure 1.6

There are different scales of climate: The smaller the scale, the more specific the consequences and effects upon the architectural design.

Dimension of Climate	Location Examples	Factors Affecting Climate	Consequences and Effects upon Architectural Design
Zone Climate	<ul style="list-style-type: none"> <li>• Central Europe</li> <li>• Germany (sub oceanic climate)</li> </ul>	<ul style="list-style-type: none"> <li>• latitude</li> <li>• altitude</li> <li>• relation to the sea</li> </ul>	<ul style="list-style-type: none"> <li>• rough features of architectural appearance</li> <li>• implantation into the countryside</li> </ul>
Regional Climate	<ul style="list-style-type: none"> <li>• geographic unit, i.e., Northern Germany</li> <li>• topographic unit, i.e., river areas, mountain or lake area</li> </ul>	<ul style="list-style-type: none"> <li>• latitude/altitude</li> <li>• continental location</li> <li>• relation to other waters</li> <li>• relief and intervals</li> <li>• relation to main wind conditions (weather/leeside)</li> </ul>	<ul style="list-style-type: none"> <li>• traditional regional architecture</li> <li>• building features</li> <li>• construction type</li> </ul>
Local Climate	<ul style="list-style-type: none"> <li>• topographic subunit, i.e., valley</li> <li>• settlement</li> <li>• developing areas</li> </ul>	<ul style="list-style-type: none"> <li>• relative altitude</li> <li>• relation to waters</li> <li>• vegetation</li> <li>• development/density/traffic</li> </ul>	<ul style="list-style-type: none"> <li>• housing type</li> <li>• ensembles</li> <li>• building shape</li> <li>• location</li> <li>• equipment</li> <li>• exterior design</li> </ul>
Micro Climate	<ul style="list-style-type: none"> <li>• plot/site</li> <li>• location of building</li> <li>• garden areas</li> <li>• interspaces</li> <li>• detail features</li> <li>• surface features</li> </ul>	<ul style="list-style-type: none"> <li>• topography</li> <li>• soil conditions</li> <li>• kind of vegetation</li> <li>• building shape</li> <li>• kind of waters</li> </ul>	<ul style="list-style-type: none"> <li>• modified building type</li> <li>• construction elements</li> <li>• detail design</li> <li>• surfaces</li> </ul>

## 1.3 Urban and Micro-Climatic Features

The relationship between areas rich in vegetation--or simply unbuilt areas-- and highly-developed areas within a city determine its climatic structure, more or less. At a certain size, a new climatic scale will be created: the urban climate.

The annual average temperature of urban areas is typically 2 K greater than the surrounding countryside. At the height of summer, temperatures can climb as high as 6 to 12 K. Higher nocturnal temperatures (up to 6 K) combined with pollution, humidity and low wind aggravate urban conditions to uncomfortable sultriness.

Overheating results from the heat retention capacity of buildings and streets, higher reflection, and absorption of sealed surfaces.

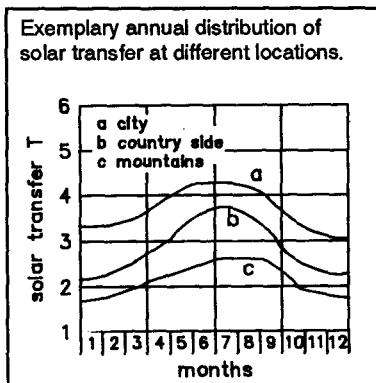

Figure 1.7

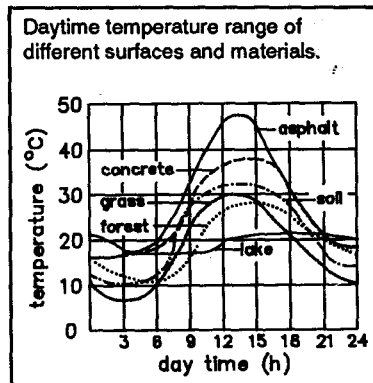

Figure 1.8

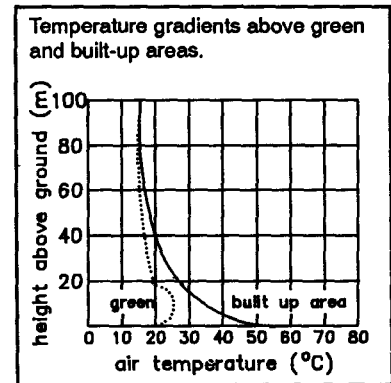

Figure 1.9

# SITE ANALYSIS

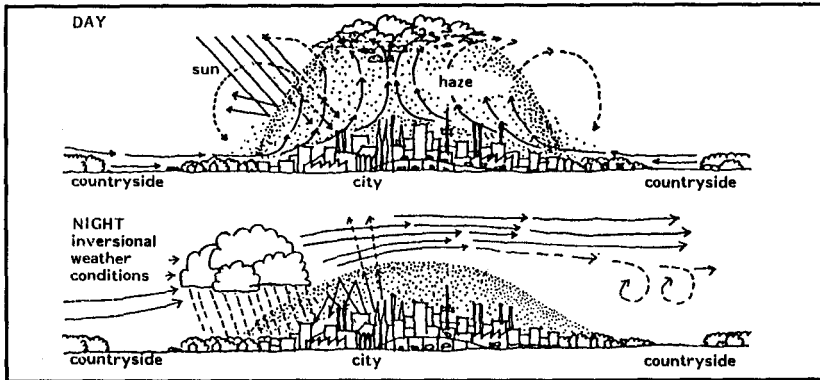

Figure 1.10

Heated air and pollution of urban areas produce a haze which leads to lower irradiation levels and poor air quality. Reduced nocturnal heat emission and inversion weather conditions support increasing fog and rain frequency by condensation of polluted air.

Urban vs. Adjacent Countryside	Cities have....
<b>POLLUTION</b>	
- dust	10 times more
- sulphur dioxide (SO <sub>2</sub> )	5 times more
- carbon dioxide (CO <sub>2</sub> )	10 times more
- carbon monoxide (CO)	25 times more
<b>RADIATION</b>	
- radiation on horizontal surfaces	15-20 % less
- ultraviolet in winter	30 % less
- ultraviolet in summer	5 % less
<b>ILLUMINATION</b>	
- visible illumination in summer	5 % less
- visible illumination in winter	15 % less
<b>CLOUDINESS</b>	
- clouds	5-10 % more
- fog winter	100 % more
- fog summer	30 % more
<b>INVERSIONAL WEATHER CONDITIONS</b>	60% more
<b>PRECIPITATION</b>	
- complete inversions	5-10 % more
- days with a minimum of 3 mm precipitation	10 % more
<b>TEMPERATURE</b>	
- seasonal mean value	0,5-1 K higher
- minimum in winter	1,0-2 K higher
<b>RELATIVE HUMIDITY</b>	
- mean value	6 % less
- winter	2 % less
- summer	8 % less
<b>WIND SPEED</b>	
- seasonal mean value	20-30 % less
- cold front	10-20 % less
- calm	5-20 % more
<b>RANGE OF SIGHT</b>	80-90 % less

Figure 1.11

The table gives values for urban climates in comparison to countryside conditions. The interplay of individual characteristics may even intensify the influence on the local climatic character.

Figure 1.12

Example of urban air pollution fractions (selected area Cologne 1972, F.R. of Germany, after Schilpköter/Goettert).

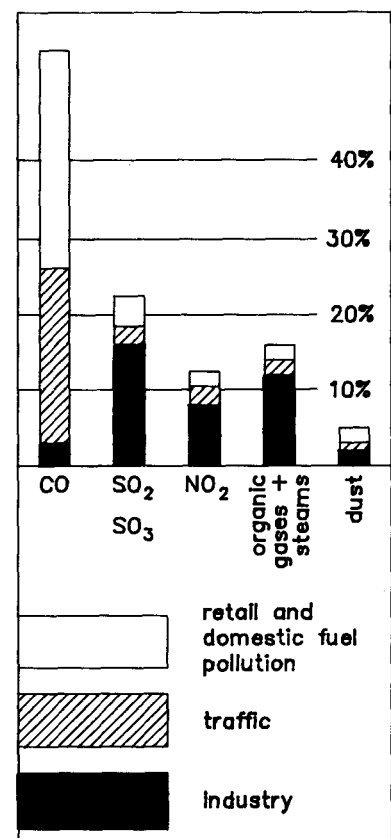

# SITE ANALYSIS

## Location of Vegetation

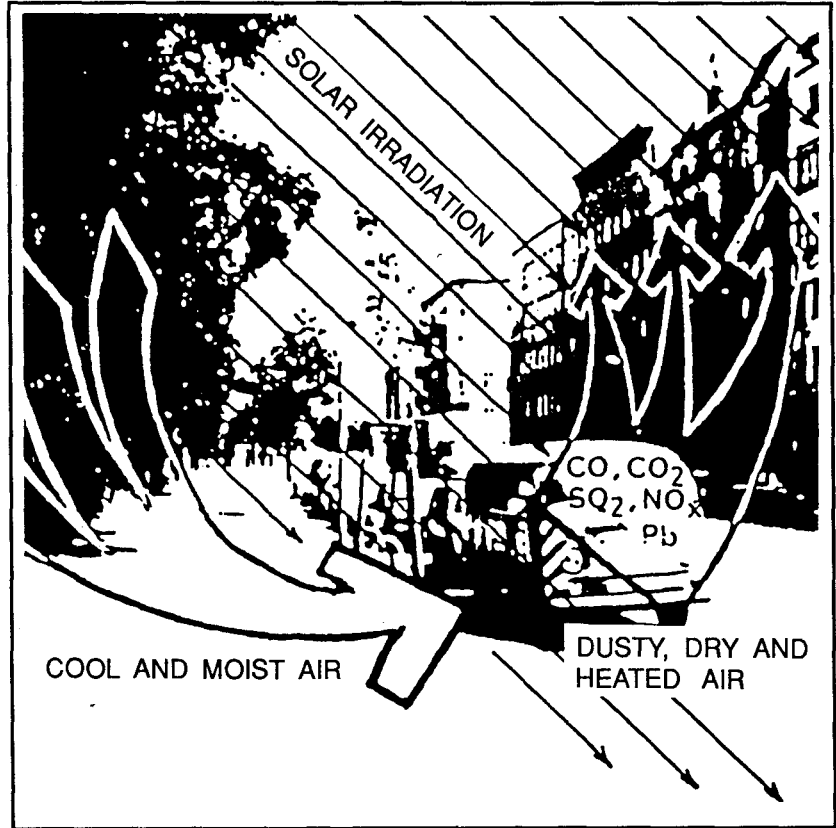

**Figure 1.13**  
 Incorrect location of vegetation: The rising dry and warm air contains pollution of the street and strikes the facades directly.



**Figure 1.14**  
 Suitable arrangement of vegetation: Directly in front of the building, the trees act as blockage against solar radiation, air filter against pollution, and reduce air velocity. Rising air is cool, moist and clean.

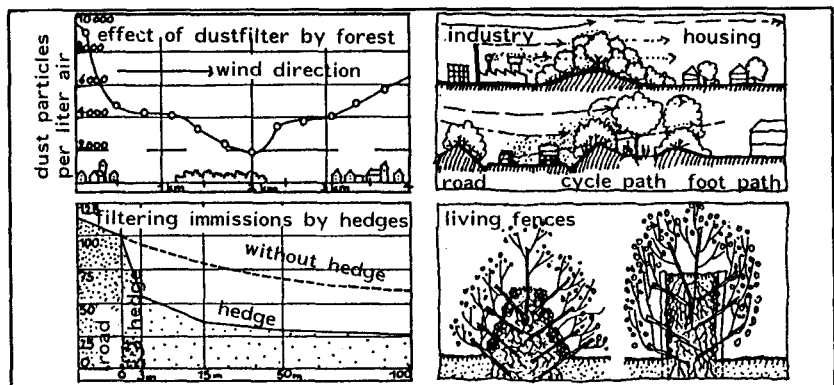

**Figure 1.15**  
 Forests, lawns, and hedges act as important dust filters near roads and industrial areas. A row of hedges of about 3 m width could reduce dust by nearly 50%. Arrangements like living fences also reduce noise levels.

# SITE ANALYSIS

The increased air pollution by traffic and industries (see figure 1.12) decreases the quality of urban climate conditions and thus the quality of life as well. In comparison to countryside conditions, the urban climate is characterized by a general degeneration of the climatic elements (see figure 1.11).

Increasing vegetation in urban areas is the most effective way for a bioclimatic improvement of dense urban settlements. Of course, the beneficial climatic effect of green spaces is directly proportional to their size. In most countries the development and protection of parks, larger green belts, and urban garden areas depends on municipal policies, which are in turn determined by master plans and zoning regulations. Therefore, the disposition of green belts is usually withdrawn from the common architectural drawing board. Nevertheless, the modest measures remaining for the planner should not be underestimated by their climate-responsive effects (see figures 1.16 and 1.17).

Aside from temperature decrease, vegetation reduces smog and fog by filtering the dust. This increases direct sunlight. Measurements (after E. Franke) have shown only a fifth as much dust in a park, and even a third along a boulevard planted with trees, in comparison to a street without vegetation. Green areas of 100 - 200 m<sup>2</sup> are practically sufficient to provide almost 3 - 4 K of cooling and reduce 1/6 - 1/8 the dust concentration compared to unvegetated areas

## Efficiency of Urban Vegetations

Figure 1.16  
Qualitative features of urban green.

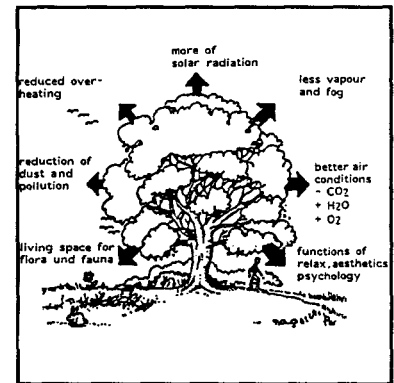

Site Variants	SITE-RELATED INFLUENCES ON MICRO-CLIMATIC ELEMENTS					Energy-Related Effects
	Characteristics of Exterior Spaces	Radiation	Temperature	Humidity	Wind	
1. extended garden areas, villa gardens, row house gardens, and larger allotments	vegetation areas with grass, hedges and trees	shading by trees according to solar geometry and to the kind of trees (deciduous)	reduction by shading and evaporation, about 3-5 K temperature gradients in comparison to urban maximum temperatures	effect of temperature reduction	reduction of air velocity (advantage in case of stormy conditions)	support of thermal micro-climate condition, reduce cooling during cold season and transition times, reduce ventilation losses and avoid uncomfortable air currents
2. smaller garden units, housing gardens	areas of lawn, plantings and water, single trees, and hedges	similar to 1. reduced built-up volume causes modest absorption and reflection, possible shading by tall trees	see 1. to a more moderate extend	see 1.	see 1.	see 1. efficiency depends directly on building orientation
3. green area substitutes: balcony, loggia, access galleries, outside corridors, roof gardens, roof terraces	partially planted exterior building spaces	plants may diminish incident solar radiation (pergolas, climber frame work) depending on construction	largely depending on radiation condition (exposure to the sun)	no significance	possible small scale calming depending on kind and density of plantings	a suitable design promotes buffer zones between indoor and outdoor conditions, improves indoor climate and avoids cold air drafts

Figure 1.17

# SITE ANALYSIS

## 1.4 What is Your Climate ?

Evaluation of given climatic conditions at a site is necessary for planning a "climatically sensitive" layout, giving maximum benefit from good weather and optimum protection from adverse outdoor conditions. Checking each month's temperature relative to human comfort requirements is the first step (figure 1.20).

What is "cold?" Often subzero temperatures and severe winters for several months require protection from heat losses and adverse weather conditions.

What is "cool?" Temperature levels below 17 °C down to 5 °C require permanent mechanical heating and benefit from the use of passive solar gains during mild winter conditions.

What is "comfortable?" When temperatures range between 17-26 °C, the building should quickly react to pleasant outdoor conditions for indoor thermal comfort. Building benefits include energy savings and improved comfort and utilization of spaces around the building for outdoor activities.

What is "warm?" Temperature periods between 26 °C and 32 °C could mostly be managed by natural cooling techniques when summer conditions are not accompanied by high humidity levels.

What is "hot?" Temperatures above 32 °C for long periods require cooling. Depending on humidity level, sun, and wind conditions, mechanical air conditioning will often be the only way to achieve thermal comfort. The building should be protected from the sun and hot air to keep cooling requirements low.

Figure 1.19  
Psychrometric chart showing space conditioning strategies to meet thermal comfort.

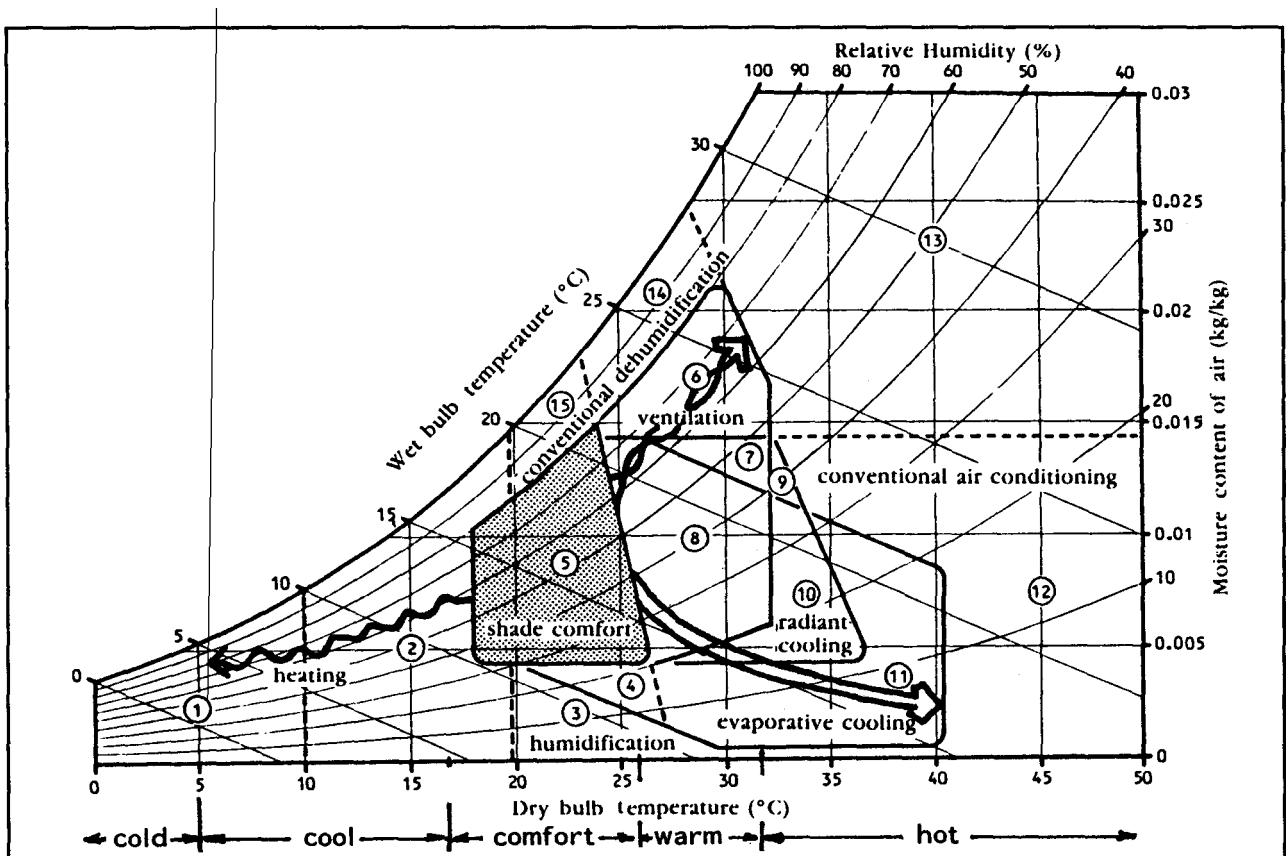



# SITE ANALYSIS

A more sophisticated assessment of dominating climatic conditions is established by marking up a psychrometric chart. Once it is filled out, the chart indicates design guidelines related to temperature-humidity interdependencies. Beyond the zone of naturally occurring comfort conditions (zone 5), different passive and conventional space conditioning strategies are recommended and necessary to meet indoor comfort conditions (figure 1.19). The necessary climatic data base is: hourly mean dry bulb temperatures for each month, and either corresponding relative humidity values or wet bulb temperatures. By plotting temperatures in such a fashion (figure 1.21) one can determine the point at which comfort zones are reached and the forms of climate control necessary to reach them.

**Figure 1.20**  
Temperature check for the city of Rome.

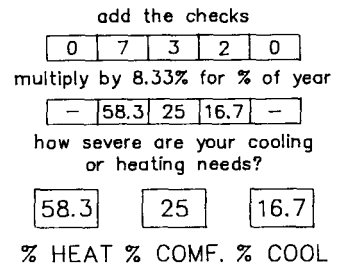
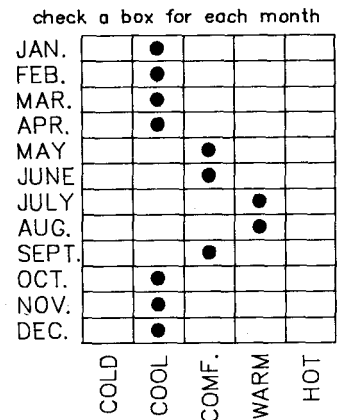

**Design strategies for reduction of heat losses by means of passive, active and conventional systems:**

- |   |      |     |
|---|------|-----|
| • reduction of transmission heat losses | zone | 1,2 |
| • reduction of infiltration losses      | zone | 1,2 |
| • solar energy gain                     | zone | 1,2 |
| • reduction of external air velocity    | zone | 1,2 |

**Design strategies for reduction of cooling loads by passive means:**

- |                                  |      |         |
|----------------------------------|------|---------|
| • natural ventilation            | zone | 6-8     |
| • reduction of insolation        | zone | 3-15    |
| • evaporative cooling            | zone | 8,10,11 |
| • radiative cooling              | zone | 7-10    |
| • reduction of heat transmission | zone | 12,13   |

Zones 12 and 13 are beyond the area where passive means could sufficiently meet thermal comfort: mechanical air-conditioning will be necessary in those regions.

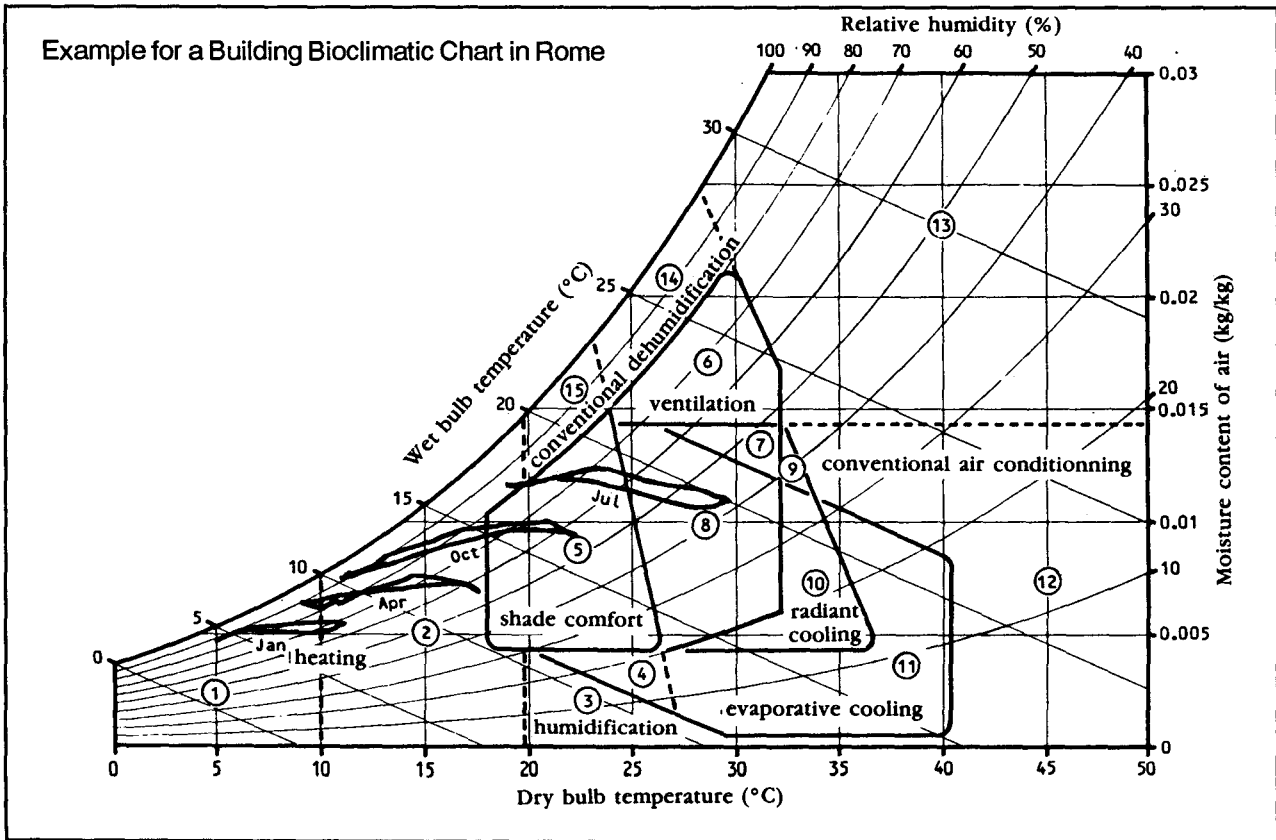

Figure 1.21

# SITE ANALYSIS

The results given in figure 1.21 reflect the climatic conditions during four months in the city of Rome: January, April, and October are too cold (zones 1 and 2). Insulation, weather-stripping, double glazing, and buffer spaces would be sufficient to reduce transmission and infiltration heat losses. Passive solar design strategies should be promoted. In July half of each day is spent in comfort (zone 5). The rest of the day is too warm (zone 8) which can be improved by natural ventilation, sufficient shading devices (protection from sun), and evaporative/radiative cooling strategies.

A number of different climatological data sources are available which are important for the design process. Depending on the method and the intended accuracy of analysis, the designer can choose either weather tapes recording long - term data (e.g., TRY - Test Reference Year) or meteorological weather statistics listed by most of the main meteorological weather stations all over the world.

One of the most illustrative kinds of climatological assessments is represented by bin data, shown in a suitable collection of plotted graphs in figure 1.22.

Figure 1.22  
Bin data collection for Rome.

- 1 Mean Temperature
- 2 Mean Radiation
- 3 Humidity
- 4 Wind Direction
- 5 Average Wind Speed
- 6 Average Days of Rain
- 7 Average Days of Fog

For practical design estimates, these data are the base for the psychrometric charts of a given location. Such graphical data illustrations provide quick checks for qualitative expectations of the relevant phenomena they identify. The charts help to determine whether and when weather acts as an asset or liability for each month, and they define the interdependencies of climatic conditions.

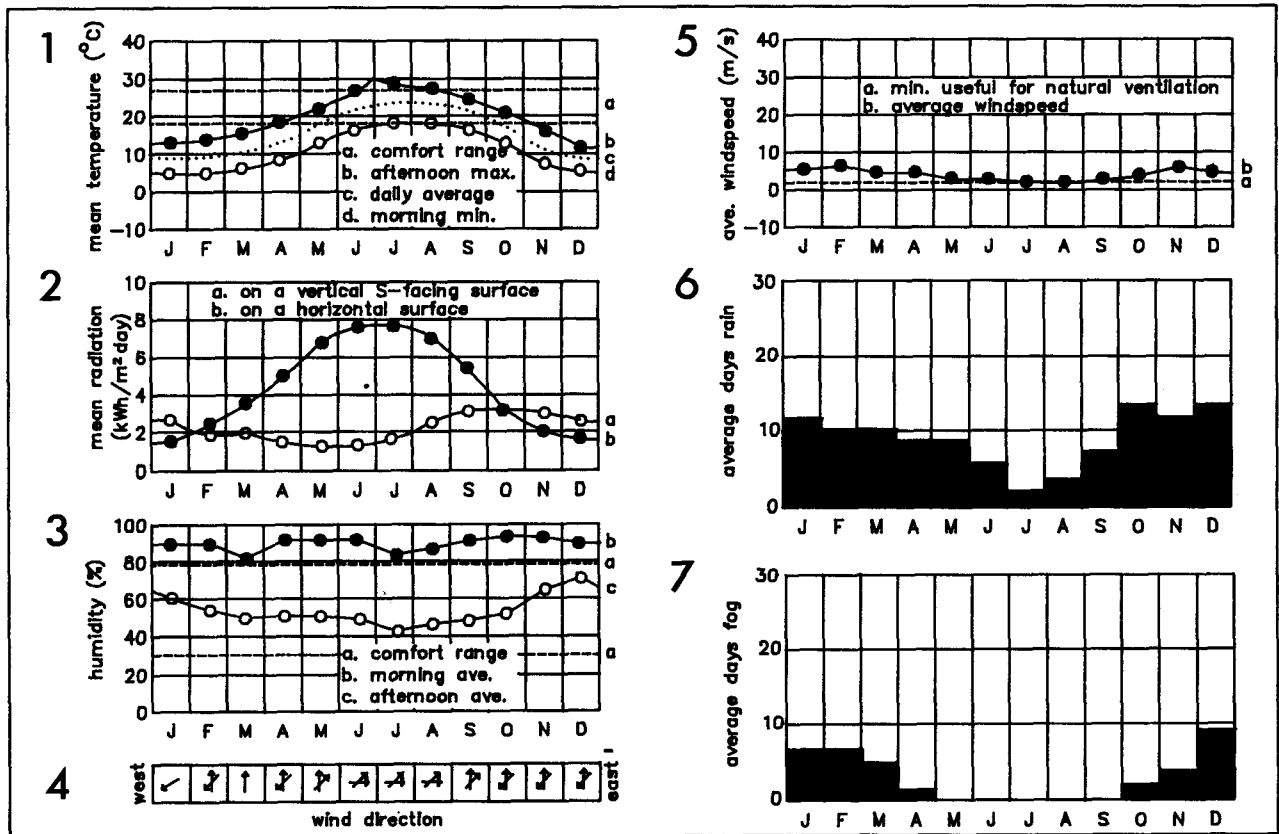

# SITE ANALYSIS

Checklists presented on the following pages identify the types of bioclimatic information that may be required to design an energy efficient, passive solar home. Because passive solar design is concerned with overall architectural features of a building, it is imperative in the early design process to collect those climate data that may represent design determinants. These data supplement the space use, size, and relationship data found in a typical architectural program.

For each bioclimatic element, three methods of data collection are presented:

- **Site Inspection**

This method concerns direct observation and inspection of the building site and environment.

- **Technical Review**

This method concerns a thorough review of available technical and climatic data and building regulations.

- **Literature Search**

This column refers to sources of information specified through the technical review process.

- **Tests**

This method concerns the development and execution of tests on the site to characterize certain bioclimatic features. Some of these are short-term and can be easily performed while others are long-term and generally not practical for most projects.

The twin page structure of the Bioclimatic Checklist is provided with 4 columns:

<b>Site Inspection</b>	<b>Technical Review</b>	<b>Literature Search</b>
<b>Tests</b>		

For practical work, the checklist serves as a conceptual framework which can be completed as is or varied, according to regional features.

## 1.5 Bioclimatic Checklist

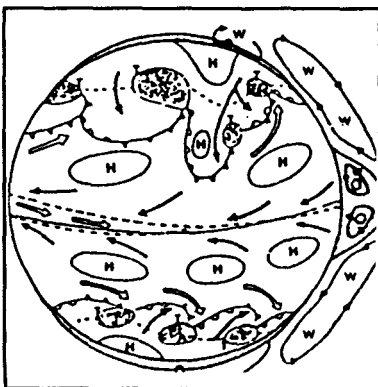

Figure 1.23

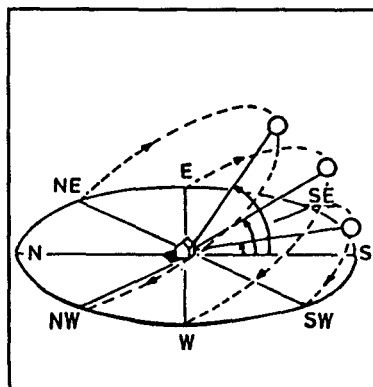

Figure 1.24

### Content of Bioclimatic Checklist

- Solar Radiation
- Temperature
- Wind Conditions
- Precipitation/Humidity
- Vegetation
- Geological Data
- Water Resources
- Building Material
- Urban Features

# SITE ANALYSIS

## SOLAR RADIATION



Figure 1.26

## TEMPERATURE

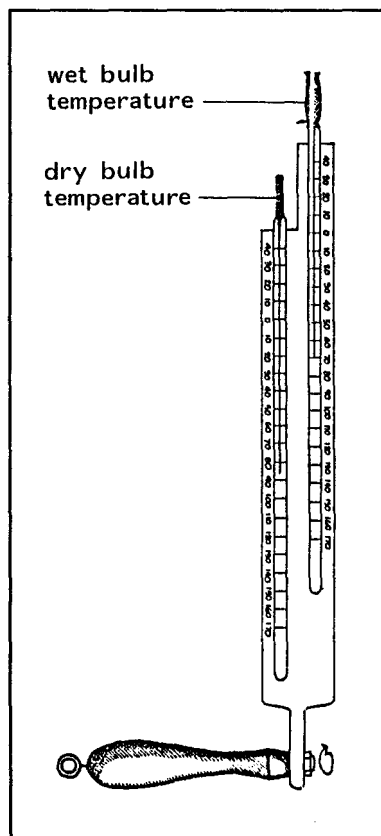

Figure 1.27

## SITE INSPECTION

- shading areas depend on
  - diurnal sun path
  - seasonal sun path
  - existing vegetation
  - topographic features
  - building environment
  - surrounding buildings

## SITE INSPECTION

- shape of ground , relief
- relation to valley, basin, slope, mountain
- specific information about slope location (bottom, top, edge, etc.)
- slope orientation and tilt
- shading areas (daily and seasonal cycles)
- relation to water (lake, river)
- fog areas and overflow level
- hoar-frost areas
- frost damage (cold air traps and flowing areas)
- snow-coverings
- snow melting conditions
- stock of vegetation (high, low, density, etc.)
- orientation, position and shape of vernacular architecture, court planting
- cultivation methods

## TECHNICAL REVIEW

- sun angles for each month
  - altitude angle
  - azimuth angle
- daily and seasonal distribution of direct and diffuse intensity of incident radiation ( $W/m^2/h$ )
- maximum and minimum of global radiation ( $Wh/m^2$ ) and direct incident radiation
- sunshine hours
- frequency of sunshine
- number of days without sunshine (annual, seasonal)
- mean total radiation on building areas (horizontal, vertical)
- solar reduction by pollution
- clear and cold days

## TECHNICAL REVIEW

### Site data:

- altitude above sea level
- relative altitude
- geographical relation

### Meteorological data:

- yearly temperature progress (daily and monthly values)
- maximum and minimum temperatures, frequency
- frequency of different types of weather
- frequency of inversion weather conditions
- growing season (days above  $5^\circ C$  and  $10^\circ C$  resp.)
- summer days ( $25^\circ C$ )
- tropic days ( $30^\circ C$ )
- sultry days ( $25^\circ C/60\%$ ;  $30^\circ C/45\%$ )
- frosty days, foggy days
- snowy days (5cm snow covering)
- frequency of thunderstorms
- frequency of pelting rain
- degree days

# SITE ANALYSIS

## LITERATURE SEARCH

all data are normally available from national, regional, or local meteorological stations

- monthly weather reports
- meteorological yearbooks
- climate atlas and cartographic manuals:
  - continental, national
  - regional, local
- specific institutions
  - agriculture-meteorological consultations
  - local research institutions
  - airports
- solar radiation manual
- local research projects may provide specific microclimatic data in some cases

## LITERATURE SEARCH

all data are normally available from national, regional, or local meteorological stations

- monthly weather reports
- meteorological yearbooks
- climate atlas and cartographic manuals:
  - continental
  - national
  - regional
  - local
- specific institutions
  - agriculture-meteorological consultations
  - local research institutions
  - airports
- solar radiation manual
- local (solar) research projects may provide specific microclimatic data

## TESTS

- appropriate long-term data measurements
- sun path diagram will give qualitative solar geometric issues: diurnal and seasonal (see Booklet No.4)

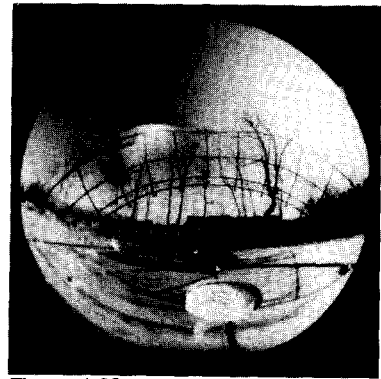

Figure 1.28

Qualitative and quantitative annual development of solar horizontal global mean radiation (kWh / m<sup>2</sup> day)

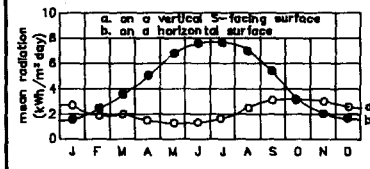

Figure 1.29

Qualitative and quantitative annual development of mean temperature levels (°C)

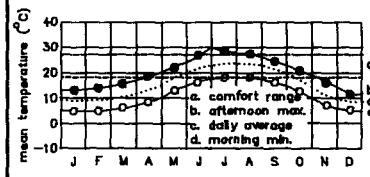

Figure 1.30

Qualitative and quantitative annual development of relative humidity (%)

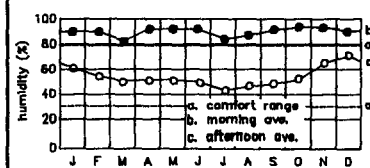

Figure 1.31

# SITE ANALYSIS

## WIND CONDITIONS

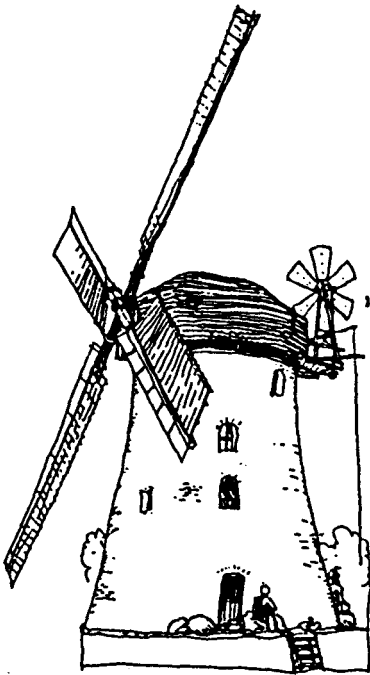

Figure 1.32

## SITE INSPECTION

- windward and leeward relationship
- traditional wind use facilities
- local wind conditions
- wind deformation of trees and hedges
- pelting rain areas at fences, trees, buildings (moss-grown)
- soil erosion by wind
- wind barriers, turbulence and jet intensification effects
- distribution of wind area, influenced by vegetation, buildings, topography, etc.

## TECHNICAL REVIEW

- windspeed (m/sec; km/h; knots)
- annual frequency
- distribution of wind direction (three - dimensional wind diagram)
- days without air movement
- possible examinations and cartographical manuals of typical local winds

## PRECIPITATION AND HUMIDITY

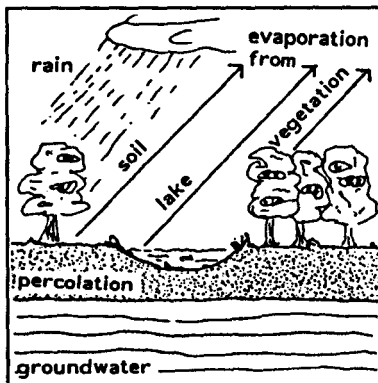

Figure 1.33

## SITE INSPECTION

- windward and leeward relationship
- local cultivation (wine, winter grain, wheat etc.)
- site drainage
- swamp meadows and humid areas
- snow fall areas
- areas of high pollution (see urban climate and emmissions)

## TECHNICAL REVIEW

- Precipitation data
  - total amount
  - kind
  - distribution (local and seasonal)
- boundaries of snow fall
- manuals of local phenomena of flowering periods
- duration of vegetation periods (corn climate, wine cultivation climate)

# SITE ANALYSIS

## LITERATURE SEARCH

all data are normally available from national, regional, or local meteorological stations

- monthly weather reports
- meteorological yearbooks
- climate atlas and cartographic manuals:
  - continental
  - national
  - regional
  - local
- specific institutions:
  - agriculture-meteorological consultation
  - local research institutions
  - airports
- municipalities
- local associations of sports aviation, sailing clubs
- meteorologically experienced farmers familiar with local wind peculiarities

## TESTS

long-term wind measurements if necessary

- speed
- direction
- frequency

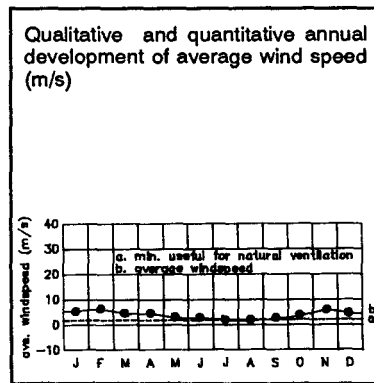

Figure 1.34

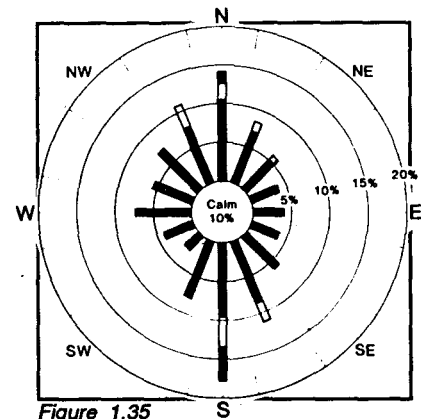

Figure 1.35

## LITERATURE SEARCH

all data are normally available from national, regional, or local meteorological stations

- monthly weather reports
- meteorological yearbooks
- climate atlas and cartographic manuals:
  - continental
  - national
  - regional
  - local
- specific institutions:
  - agriculture-meteorological consultation
  - local research institutions
  - airports
- national, regional, and local meteorological stations
- some countries have bi-climatic manuals with phenomena-related issues

## TESTS

measurement of precipitation

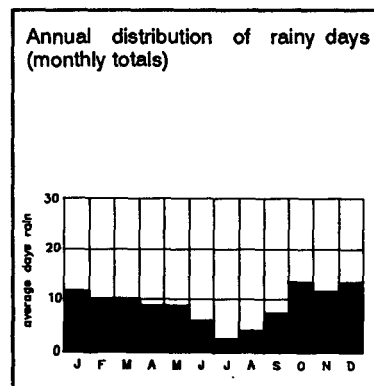

Figure 1.36

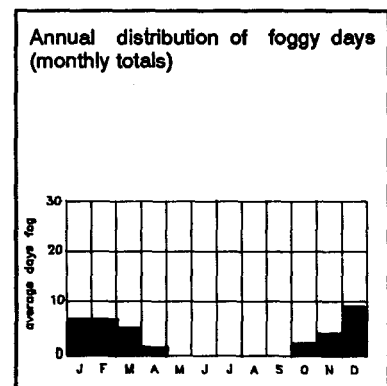

Figure 1.37

# SITE ANALYSIS

---

## VEGETATION

### SITE INSPECTION

- kind and distribution of covered / uncovered areas
- identification of the most important plants
- location of trees according to their species, number, height, age, diameter of trunk and crown
- observation of pathological symptoms / morbid states
- agricultural methods / kind of cultivation concerning forests, meadows, and acres

### TECHNICAL REVIEW

- maps of existing vegetation
- cartographical locations of areas of landscape, nature, and water protection (biotopes)
- zoning plan
- field maps

## GEOLOGICAL DATA

### SITE INSPECTION

- inspection of topography:
  - slope orientations
  - tilt angle
  - relief and intervals
  - ground level, changes
- surface structure (rocks, crude soil, overgrown)
- erosion by wind and/or rain (drifts and siltings)
- artificial ground modellings
- traditional building materials
- soil conditions:
  - top soil (humus) and consistence
  - organic fractions
  - components of mud, clay, sand, stones a.s.o.
  - building rubbish or other garbage fillings

### TECHNICAL REVIEW

- relief maps
- topographical sections
- geological maps
- bioclimatical maps
- infra-red photography and maps

## WATER RESOURCES

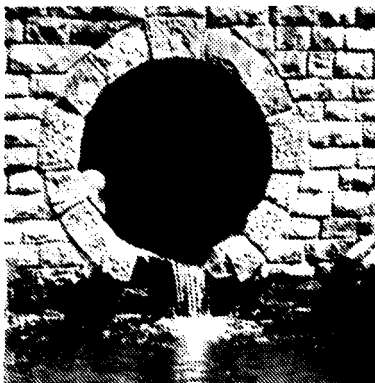

Figure 1.38

### SITE INSPECTION

- underground water:
  - moist areas with plants
  - level and quality of wells
- tilt of site, level variations
- dams and water terraces
- amount of overflow waters
- drainage paths
- traditional use of waterpower
- analysis of rivers and lakes:
  - quantity/quality of water
  - condition of shores: natural, eroded, fortified

### TECHNICAL REVIEW

- geographical conditions
- seasonal water masses of rivers
- frequency of overflows and dry periods respectively
- snow heights and melting water conditions



# SITE ANALYSIS

## LITERATURE SEARCH

- federal and regional institutions with responsibilities for environmental protection faculties of universities
- public and private research institutions
- private persons like natural physicists and scientific teachers
- forestry commissions
- municipalities

## TESTS

- stock listing by
  - enumeration
  - map making



Figure 1.39

## LITERATURE SEARCH

- public institutions and research institutions engaged in landscape protection
- public and private federations and alliances concerning environmental interests
- municipalities
- construction agencies (e.g., highway departments)

## TESTS

- levelling
- level barometer
- aerial photographs
- examination of soil by
  - taking samples
  - boring tests and analysis

nocturnal cold air gap at the bottom of a hill

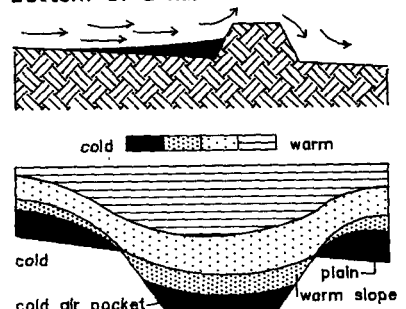

nocturnal heat stratification at basin - hill - areas

Figure 1.40

## LITERATURE SEARCH

- municipalities
- meteorological stations
- department of water supply and conservations
- health department
- environmental protection agencies
- agricultural institutions

## TESTS

- measurements of
- water masses
  - flowing velocity
  - falling height
  - seasonal differences

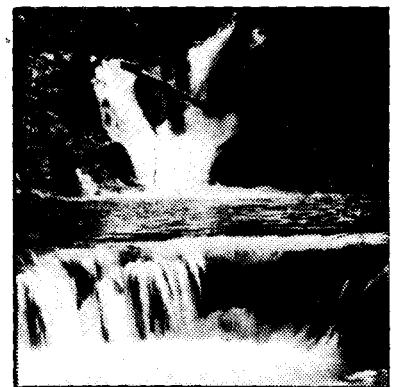

Figure 1.41

# SITE ANALYSIS

## BUILDING MATERIALS

## SITE INSPECTION

- availability of natural building materials
  - clay, stone, sand, gravel lime
- organic building materials:
  - timber, reed, brush-wood, etc.
- traditional architecture

## TECHNICAL REVIEW

- ability of applications and treatment
- transport and conditions: distances and expenses

## URBAN FEATURES

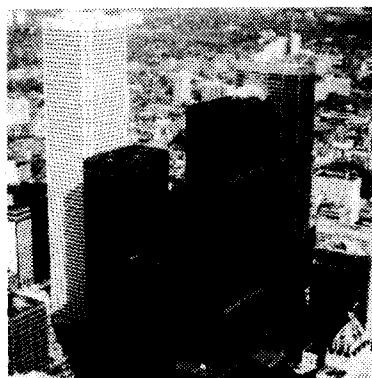

Figure 1.42 a, b, c

## SITE INSPECTION

- kind and density of building structure
- ratio of darkening and pollution
- kind, density, and distribution of planted and natural vegetation
- fresh air conditions
  - barriers
  - lanes
- dust, soot, and other sediments of particles
- disturbing odours
- distance to roads
- traffic yield, daily and weekly distribution
- distance to foul air pits and channels, industrial chimneys
- vegetation as a filter against pollution
- waste heat opportunity from neighbourhood (industrial and commercial facilities)
- bio energy from waste products, agricultural biomass, recycling material from private households and commercial facilities.
- indicators for evaporation and deformation of lake and river shores, fish-dying
- waste water infiltration into rivers
- overheating of waters
- noise disturbance at certain times of day (rush hours) and during weekend traffic
- symptoms of illness and disturbances of plants / trees

## TECHNICAL REVIEW

- spot-check measurements for air and water pollution
- identifying the main producers of pollutants, especially in main wind direction and flow direction of underground water and rivers, i.e. power plants (coal, fuel, gas)
- emissions from industries, especially chemical factories
- rubbish and other deposits
- frequency of near by traffic and future increases
- wind direction and frequency
- noise and sound level measurement (if existing)
- utility infrastructure like fuel and gas lines
- expertise in preservation of flora and fauna
- additional information for dense urban areas
- correction factor for pollution
- frequency of cloudiness, thunderstorms, inversion weather conditions, smog, local overheating, wind conditions
- pollution monitoring devices
- emission record

# SITE ANALYSIS

## LITERATURE SEARCH

- municipalities
- forest commissions

## TESTS

- structural
- fire
- biological

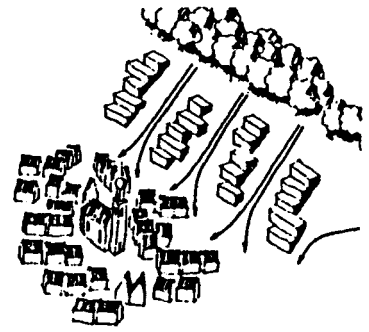

## LITERATURE SEARCH

- public and research institutions engaged in landscape protection
- public and private federations and alliances concerned with environmental interests
- institutions for health and hygienics
- department for preservation of natural resources and wildlife
- federation for environmental protection on local, regional, and national levels
- private persons and citizen initiatives
- municipalities
- land-register office
- ministries for environmental protection
- (technical) supervising utilities, authorities
- factory inspection
- public health department
- building authorities

## TESTS

- all kinds of pollution measurements
- indication tests with plants and animals

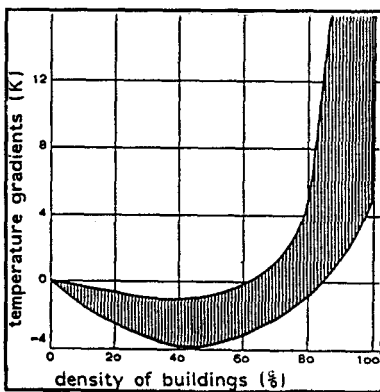
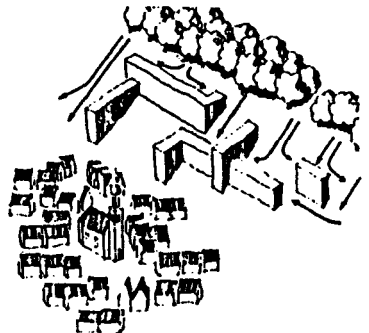

Figure 1.43

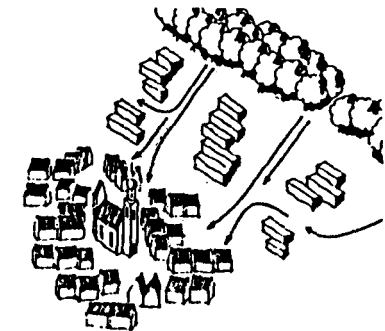
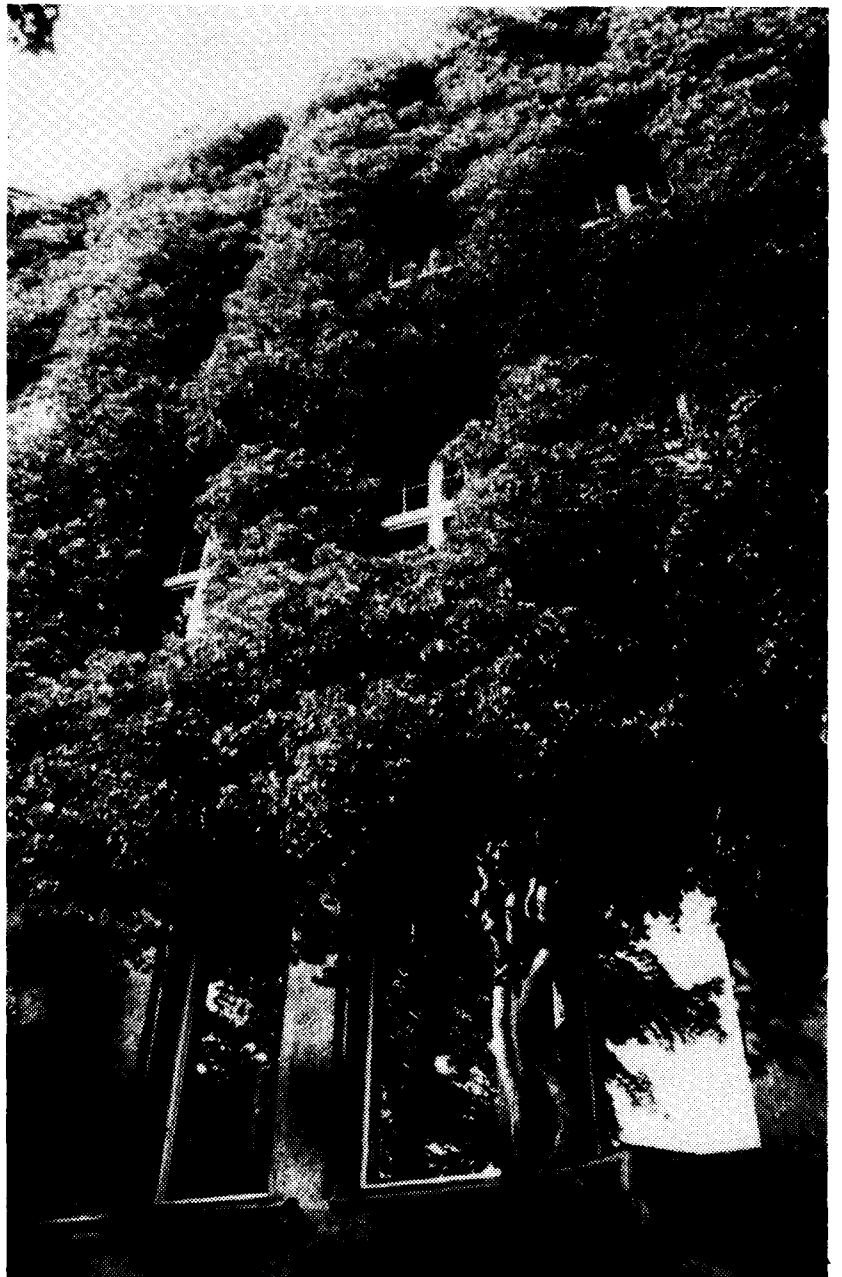

Figure 1.44



*Figure 1.45*  
Green facade of a multi-story residential building (1904) in Berlin, Germany. the density and thickness of approximately one meter also creates a living space for urban fauna.

The design of the building envelope directly influences its heating and cooling energy requirements and potential for using passive solar energy. Through the appropriate selection, sizing and organization of materials and products into building surfaces and spaces, the building becomes an energy efficient filter between the outside and indoor environments.

This chapter discusses the bioclimatic relationship between the building and the sun, wind, topography and vegetation. The concepts of thermal zoning and buffer spaces are also presented.

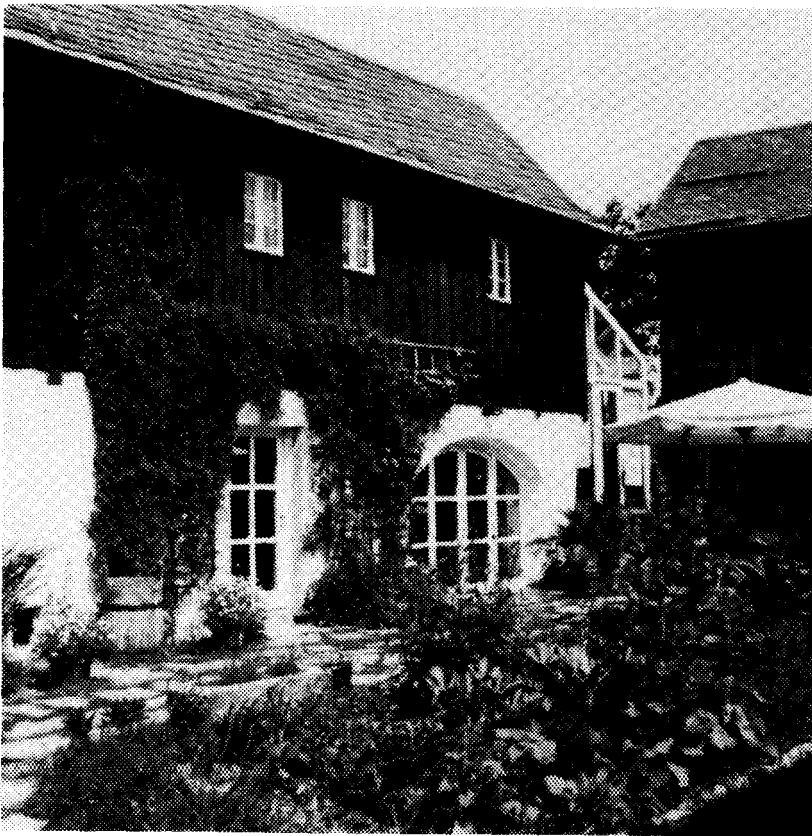

*Figure 2.0*

An example of a retrofit design for bioclimatic and regional architecture which takes into consideration the preservation of building monuments.

This farmhouse, which is more than 200 years old, is located in one of the coldest areas in Germany. It belongs to an ensemble of a farmstead which is protected as a historic landmark and which has been converted into a modern standard residence. The design objectives included the consideration of the traditional building structure as well as the reorganization of the original floor plan. The bioclimatic design approach included environmental aspects, such as topography, microclimate, and local vegetation issues, improvement of insulation levels, passive solar energy strategies,

# BUILDING ORGANIZATION

---

## Checklist

### Building Shape

- Identify any site or spatial requirements that may constrain or dictate building form
- Define the volumetric limitations of envelope that may be required by building, zoning or solar access regulations

### Building - Sun Relationship

- Assess the solar access of the various building locations on the site
- Determine which building surfaces are likely to receive direct sunlight and which surfaces are likely to be shaded
- Identify the function versus time of use, and versus solar

### access Building - Wind Relationship

- Define areas of the site or spaces within the building that have special requirements for wind protection or ventilation
- Determine seasonal wind patterns, speed and frequency and assess how these may be influenced by microclimate conditions of the site

### Building - Vegetation Relationship

- Identify existing plants (trees, hedges and so on) that could be integrated into the design as wind breaks, window or building shading, humidity control, outdoor space definition
- Identify plant species that can be introduced into the site and building design as wind breaks, window or wall shading, outdoor space definition and so on. Consider type of plant, growing requirements, appearance, planting distance, resistance to disease

### Building Spatial Organisation - Thermal Zoning

- Define the comfort requirements and utilization patterns of spaces within the residence
- Identify those spaces that could be grouped together based on their comfort requirements
- Identify those spaces that could be used as a buffer zone to other spaces in the building (air lock ,entry, porch, storage, workshop, garage)

Building shape and its relation to surface area and volume (NV) should be considered during the pre-design stage. Since heat demand of a building is proportional to its heat transmitting exterior building surface, minimum envelope should be a design consideration. Different geometrical forms are characterized by different compactness (NV). In comparison to a cube, representing 100% surface area, a cylindrical body has 87%, a semi-globe only 77%. The heat demand of the same volume, piled up as quarter cubes, increases to 135%.

In some countries this fact has been considered within building codes and regulations concerning the specification of heat demands of buildings. Though it could be desirable to optimize NV value, there are a lot of contradicting factors like function, building codes, and aesthetic requirements. Depending on building type, the fraction of envelope area, and consequently the energy demand, is very different. The most energy expensive type is the detached home (figure 2.2). Apartments in multistory buildings even show different energy demands according to their location (center or edge) and orientation (figure 2.3).

However, the evaluation of heat losses by NV - ratio has to consider the insulation level of the building envelope. For highly insulated buildings, the building shape is a minor energy use determinant in comparison to a poorly insulated building. The reason is the different effect of the heat transfer coefficient. This value determines the amount of heat loss at the exterior surface of the building envelope. Since this value is always the same for a given building, the fraction of convective heat loss varies depending on the insulation level of the envelope.

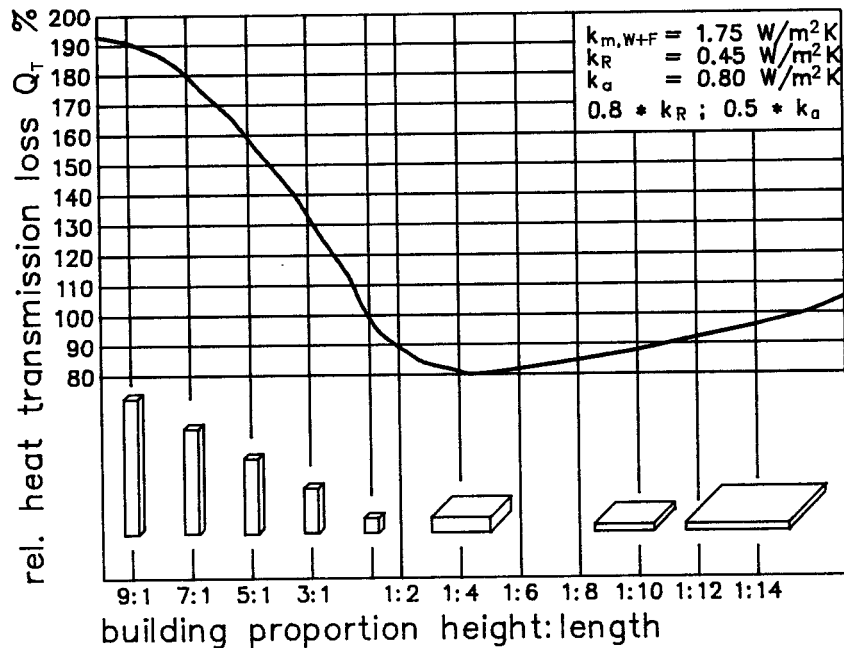

**Figure 2.2 Energy Losses and Building Proportion:** Different building forms are characterized by different amounts of transmission losses, presuming the same U-values of building envelope. The building proportion height to length of 1:4 is the theoretically optimal building form.

## 2.1 Surface Area and Volume

considerations of building shape upon heat loss solar gain aerodynamic

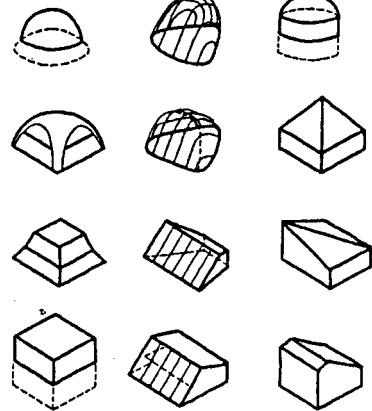

**Figure 2.1** Considering only the geometry of a building, the most suitable shape differs according to its energy-related demand: minimizing heat losses requires the shape of a semi-sphere; maximizing solar gain calls for a cone-shaped opening to sun and minimizing wind resistance may ask for any combination of both.

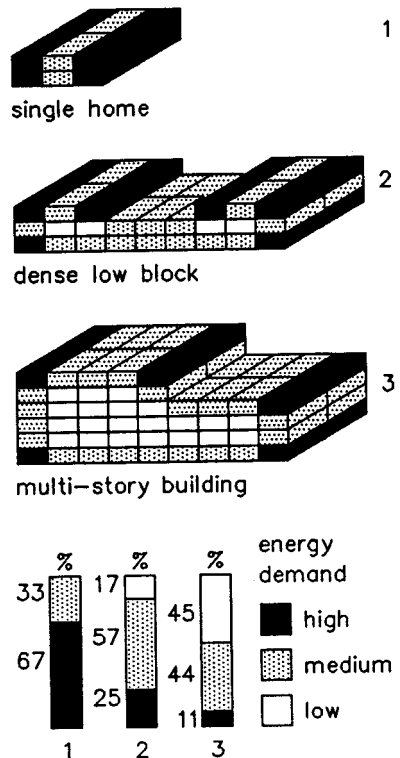

**Figure 2.3** Volume fractions of rooms of different heat demand according to building types.

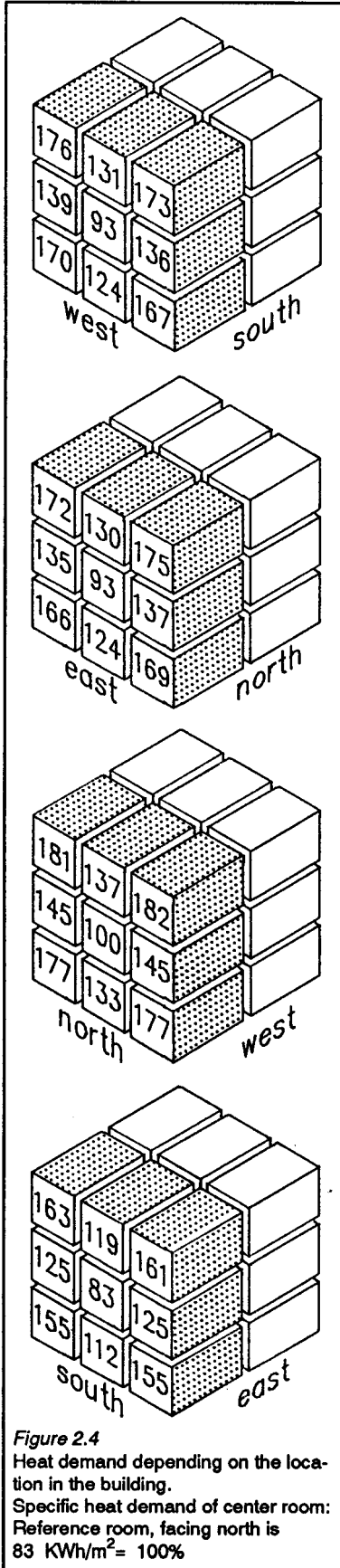

The aspect ratio of a building affects energy loads in summer and heat losses in winter. Depending on different latitudes and climates, these energy flows should be considered when developing a design solution. Figure 2.5 shows idealized proportions of length (south facade) and width (east/west facade) for the four major climatic zones in a schematic way. Proportions of 1:1 solar gains in summer (cooling loads) and heat losses in winter (heat demand) are adjusted. The intersection of the two curves is on the zero line. The indicated best building proportion serves as a rule of thumb and should be understood as a relative optimum to be considered without restricting the overall design flexibility.

### Example 1: cool climate

Intersections of suitable energy balance are variations between 1:1 and 1:1,3. The best is 1:1 because the curve representing winter has maximum of solar gain.

### Example 2: temperate climate

The best proportion is 1:1,6 since in this climate (intersections on zero line 1:1 and 1:2,4) summer maximum and winter maximum is beneficial.

### Example 3: hot-dry climate

Intersections with zero line are 1:1 and 1:1,6. This climate calls for avoidance of cooling loads in summer and winter; heating demand should not rise as well. Consequently, the optimum proportion is indicated by summer minimum.

### Example 4: hot-humid climate

Intersections on zero line are 1:1 and 1:3. The best aspect ratio is 1:1,7 - summer minimum - to avoid overheating. Winter gains should be minimized by means of natural ventilation.

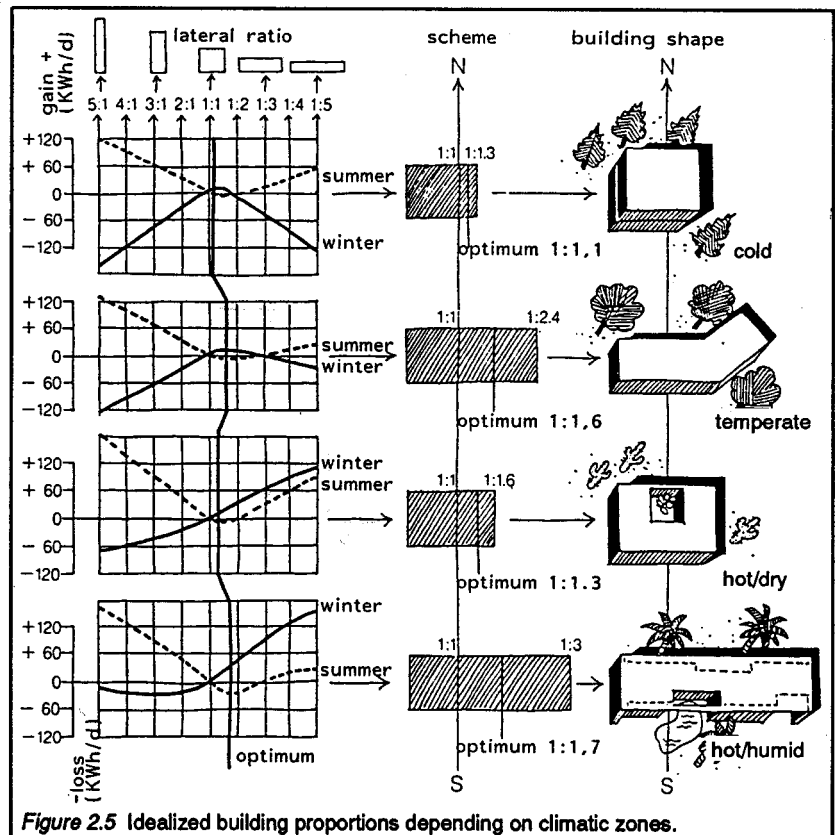



Solar access is a requirement for passive solar heating systems. The amount of solar radiation at any location on a site depends on meteorological/climatic conditions of diurnal and seasonal solar availability. The necessary data of monthly mean values, daily and/or hourly values, are required for quantitative calculation methods to estimate the efficiency of passive solar systems. To increase or reduce incident solar radiation on a building, orientation and solar aperture should be carefully adapted to the specific conditions of the site. Solar geometric conditions (sun path), building shape, and natural/artificial environment as potential shading elements should also harmonize with non energy-related design goals. Solar use by passive - hybrid systems for heating purpose and suitable sun protection against overheating risks in summer are initial questions during the building organization process.

Sun path diagrams (figure 2.7) have been developed for each latitude. They are necessary for qualitative estimate for solar access on apertures during the schematic design stage.

To determine the diurnal and seasonal position of the sun at a certain location (latitude) in a practical way, it is necessary to project the sky dome with its simulated two - dimensional sun movement onto the horizontal observation plane. The result is the graph below, for 51° northern latitude, as an example.

Solar incident radiation conditions depend on latitude and local climate features. When evaluating solar exposed building components and solar apertures one must consider geometric conditions and seasonal space conditioning demands. For climates requiring both heating and cooling, advantages and disadvantages of any particular schematic design should be checked against each other (see Booklet No. 3).

## 2.2 Relation to Sun

Figure 2.6

The house of ΣΟΚΡΑΤΗΣ is one of the oldest examples of solar houses: cone-shaped in floor and section, the south facing facade allows maximum solar access in winter. An overhang designed due to sun path avoids overheating in summer, prevailing northern winds will be diminished by hedges and diverted over the roof.

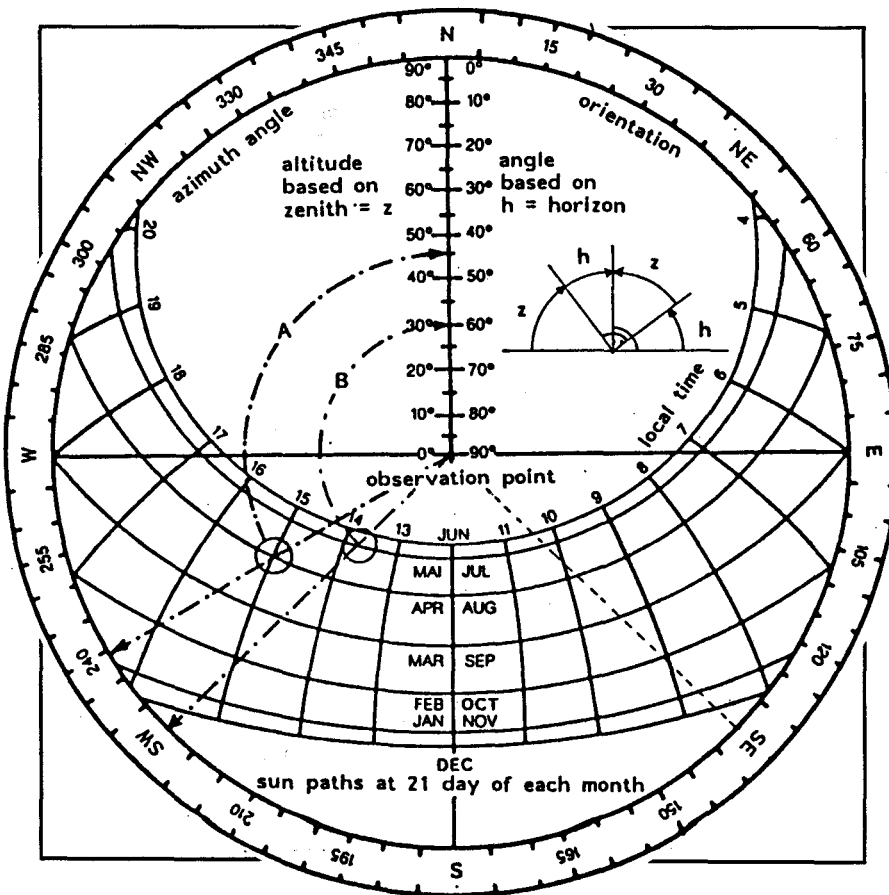
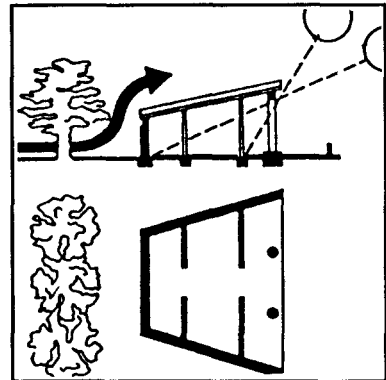

Figure 2.7

Example of reading the sunpath diagram:

- A On this latitude direct sunlight will strike a horizontal plane both on April 21 and August 21 at 3 pm by an azimuth angle of 239° (deviation from true south 59°) and an altitude angle of 45°.
- B A south-west facing surface of 30° inclination will get perpendicular solar incident radiation approximately on both May 25 and July 25 at 1:45 pm (in cases of tilted surfaces zenith angles Z and altitude angles h are corresponding to each other).

# BUILDING ORGANIZATION

In northern latitudes, north walls receive only diffuse radiation during most of the year. For this reason they cannot be used for solar energy gain. Windows should usually be minimized; in exceptional cases when large glazing is required, good thermal quality and movable insulation is recommended.

Southern walls receive appreciable solar gains. In vertical position they maximize winter solar collection and reduce summer overheating risks by good reflection of high solar incident radiation angle. Simple overhangs and/or horizontal louvers reduce cooling loads.

Eastern and western walls experience comparable solar gains. The maximum occurs in summer (morning and afternoon), causing overheating problems, especially for large glazing areas, even during transition seasons. During the heating season, however, these surfaces receive only a few hours of sun and therefore they are not practical for solar gain systems. Necessary windows should be sized adequately since reasonable sun and glare protection can only be realized by side fins and/or vertical slats. The overheating problem is even more serious for western walls in summer when the whole building has already accumulated heat by increased outdoor temperatures and the permanent solar irradiation onto its envelope during daytime.

The application of sloped glazing surfaces is a problem as they may increase overheating in summer and/or increase heat losses in winter. For the individual design of passive systems, the orientation of the sun collecting areas, their construction and physical properties must be carefully considered (see chapters 3 and 4). Otherwise, solar energy benefits in winter are achieved at the expense of overheating in summer.

**Figure 2.8**  
Walls with various orientations show different diurnal solar incident radiations ( $W/m^2$ ) depending on annual sun paths (example Vienna, latitude  $48^\circ$  north).

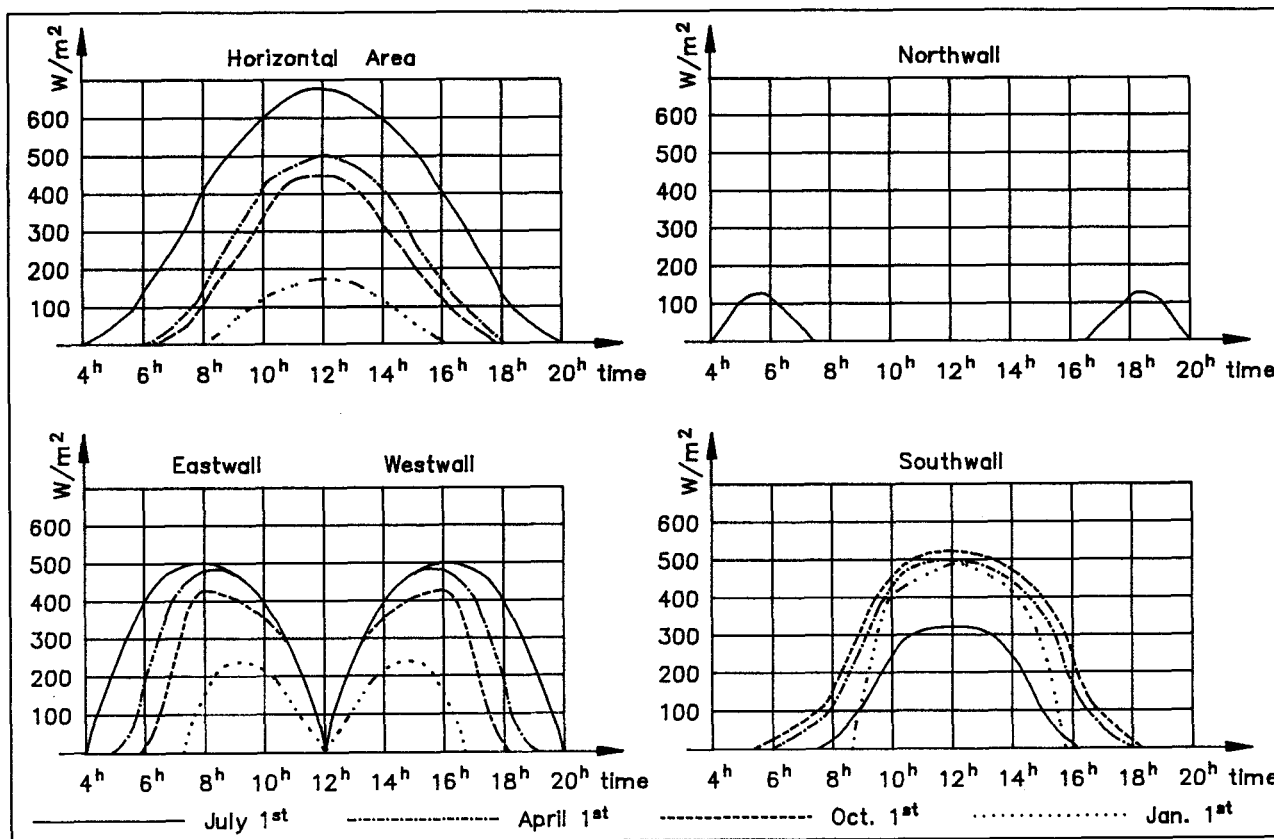

# BUILDING ORGANIZATION

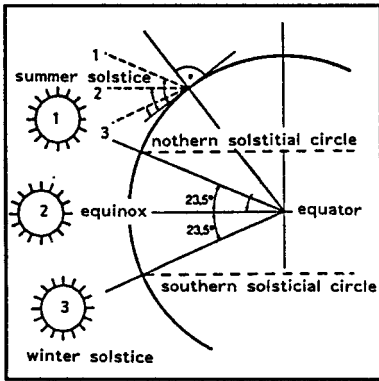

Figure 2.9

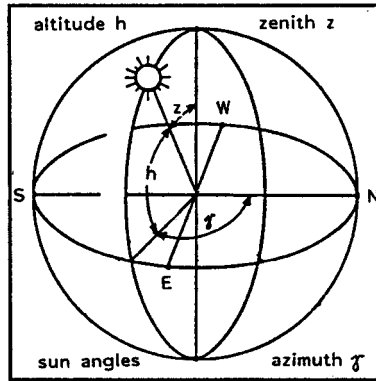

Figure 2.10

## GLOBAL LEVEL

Relation of earth and sun define climatic zones and seasons. Incident solar radiation at any location is determined by solar geometry. The tilt angle of earth's axis,  $23,5^\circ$ , is responsible for the different seasons of northern and southern hemisphere. Solar altitude and azimuth (deviation from the south) define insolation conditions at any location.

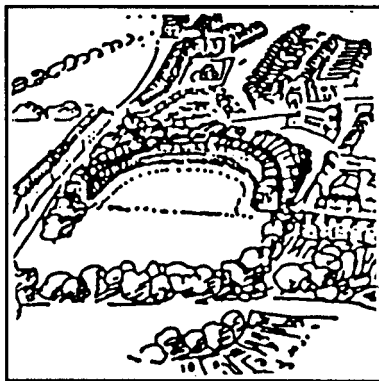

Figure 2.11

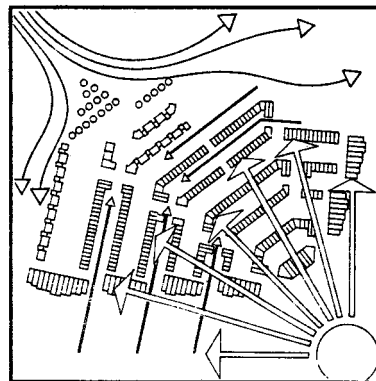

Figure 2.12

## URBAN LEVEL

Consideration of solar geometry may lead to specific urban design patterns. Depending on climatic zones and latitude, urban development and building structures should guarantee solar access for each building during heating periods and avoid overheating in summer. Human settlements should be integrated into the bioclimatic environment.

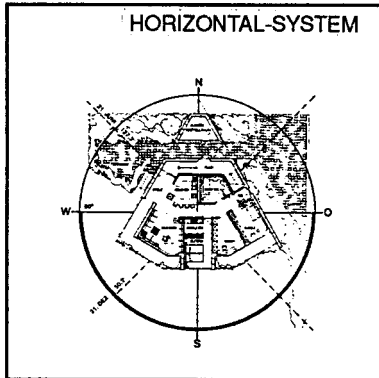

Figure 2.13

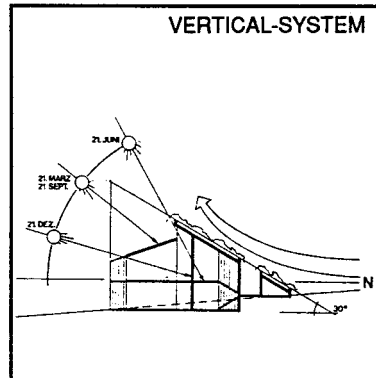

Figure 2.14

## BUILDING LEVEL

Passive solar building design can adapt to a variety of building shapes. Depending on climatic conditions the appearance of a building may consequently reflect insolation, e.g., by the shape of a three-dimensional cone according to the local sun paths. Nevertheless, each building may act as a solar collector, independent of its particular shape, when properly designed.

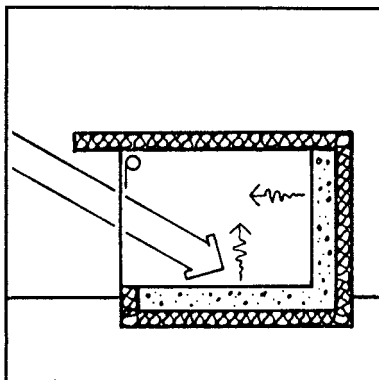

Figure 2.15

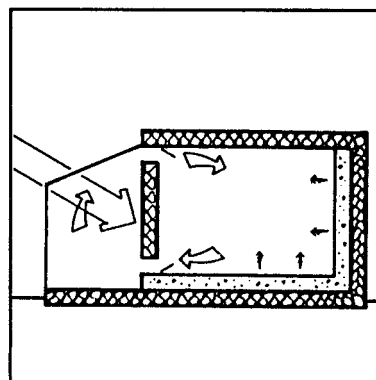

Figure 2.16

## SYSTEM LEVEL

Passive solar energy use can be realized by different systems. Glazing areas act as solar apertures to minimize auxiliary heating demand. Sizing of the system depends on local incident solar radiation conditions. The choice of wall/floor material is important for system efficiency. Movable insulation and shading devices may be required, depending on the individual system.

## 2.3 Relation to Wind

Wind originates from solar thermal influence by heating air above ground. Air movement results from the rise of warm air and the subsequent cool air flow. Wind patterns are affected by macro- and micro-climatic conditions, topographic features and sea - land relations. Wind has a strong impact on the local climate.

Figure 2.17 shows the characteristics of wind in a three-dimensional wind diagram: speed (knots), direction (north, south, east, and west) and the lines of equal numbers show equal frequencies. Seasonal wind conditions of a site should be considered for building location and design to develop a suitable strategy for summer wind use (natural ventilation) and protection from winter wind.

Winter winds increase heat loss from a building by convection (see Booklet 1, Energy Design Principles in Buildings). Summer winds may either increase or decrease natural ventilation by mechanical pressure, depending on the location of vents. However, with greater attention paid to building tightness, the influence of wind on heat loss is diminished.

Comfortable microclimatic conditions in a building environment can be improved by the shape and the location of the building on the site. Building surfaces exposed to prevailing winds in winter should be minimized and/or protected by existing plants and topographic situations. Lee-side calm areas offer comfortable outdoor spaces; when laying out such spaces, the design should also consider the solar access.

Wind speed increases according to the height above ground (figure 2.24). Certain building structures and shapes may even increase air velocity by venturi effects.

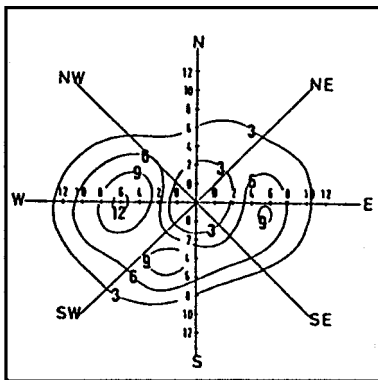

Figure 2.17

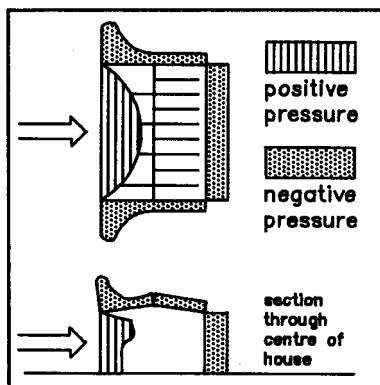

Figure 2.18

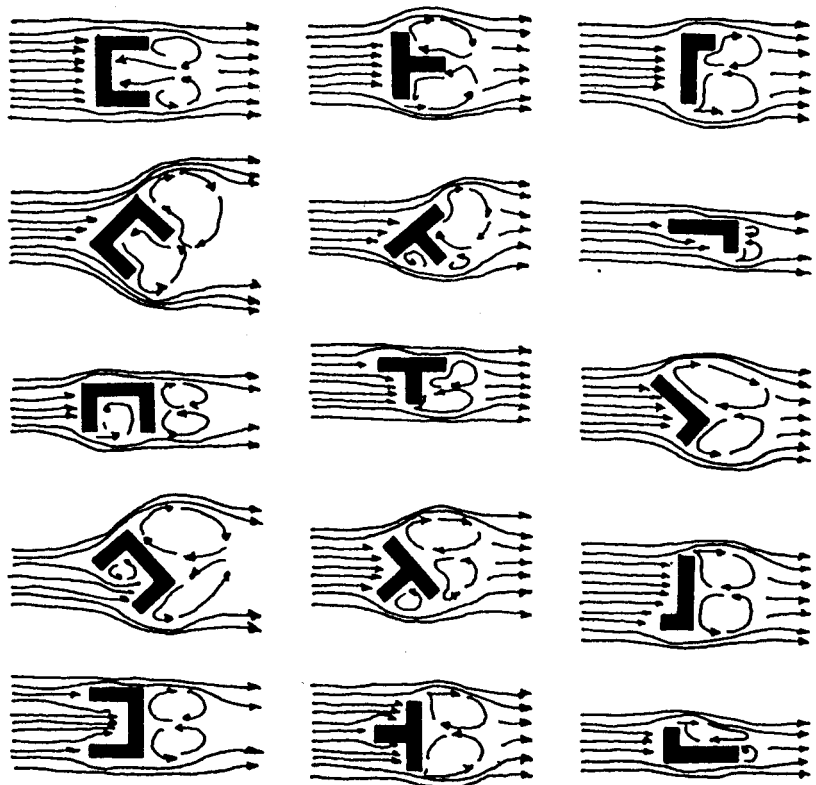

Figure 2.19

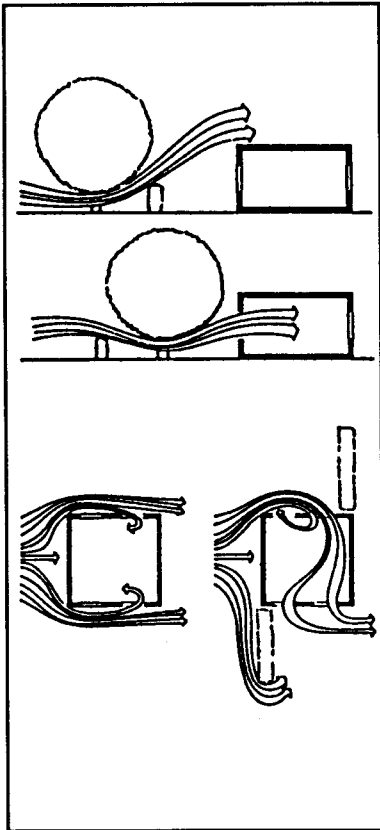

Figure 2.20

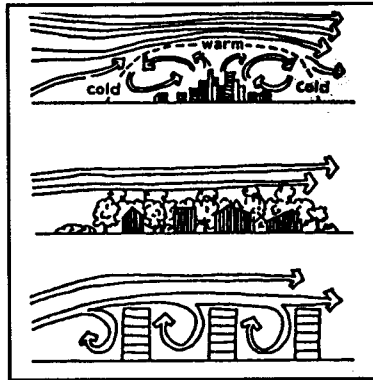

Figure 2.21

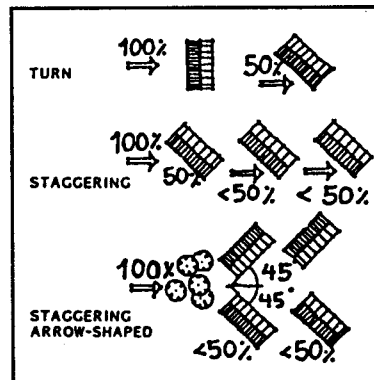

Figure 2.22

Figures 2.20 - 2.21

Trees and hedges influence the quality and quantity of air movement. Height, density, and distance to the building should be considered depending on ventilation needs and/or wind protection requirements.

Figure 2.22

Reduction of wind pressure by turning or staggering building orientation, or by use of protective vegetation.

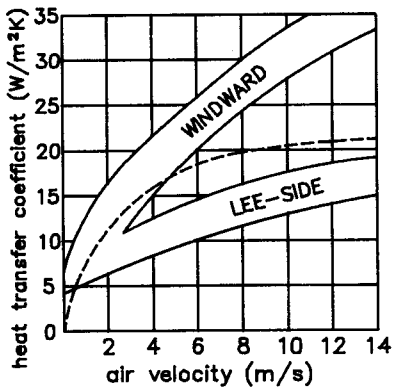

Figure 2.23

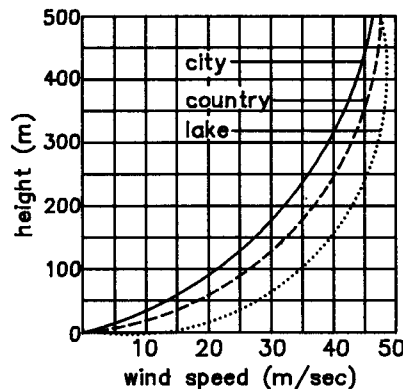

Figure 2.24

Figure 2.23

The heat losses of an exterior wall increase with velocity. In opposite to leeside situation, a windward orientation may double heat losses based on an air velocity of 6 m/s. In tightly built structures, this effect is negligible.

Figure 2.24

Heat losses are proportional to air velocity which increases, depending on roughness of ground, according to the height above ground.

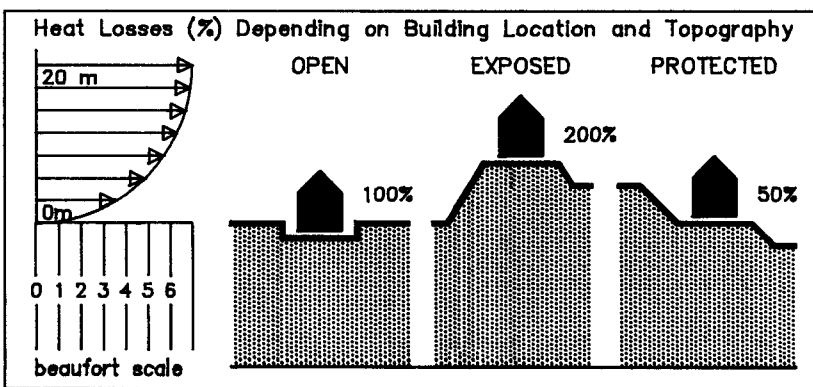

Figure 2.25

Figure 2.25

Depending on the energy design features of a building (infiltration, material, thermal quality, insulation level) heat losses by convection could rise up to 50% of total energy balance for a very leaky house.

# BUILDING ORGANIZATION

## 2.4 Relation to Topography

Earth sheltering is one way to save energy. However, the excellent thermal performance of underground houses does not result solely from the insulating qualities of the earth.

In comparison to rigid insulating materials, soil has a high thermal conductance (figure 2.31) and requires significant earth thickness to equal the thermal qualities of insulation. Rather, the energy-saving effect of earth sheltering is based on a reduction of heat losses in winter and heat gain in summer by the effect of temperature moderating. The stable temperature of soil, depending on kind of material, depth, and moisture content, protects the house with soil warmer than average air temperatures. This buffering factor (chapter 2.3) also reduces overheating effects in summer.

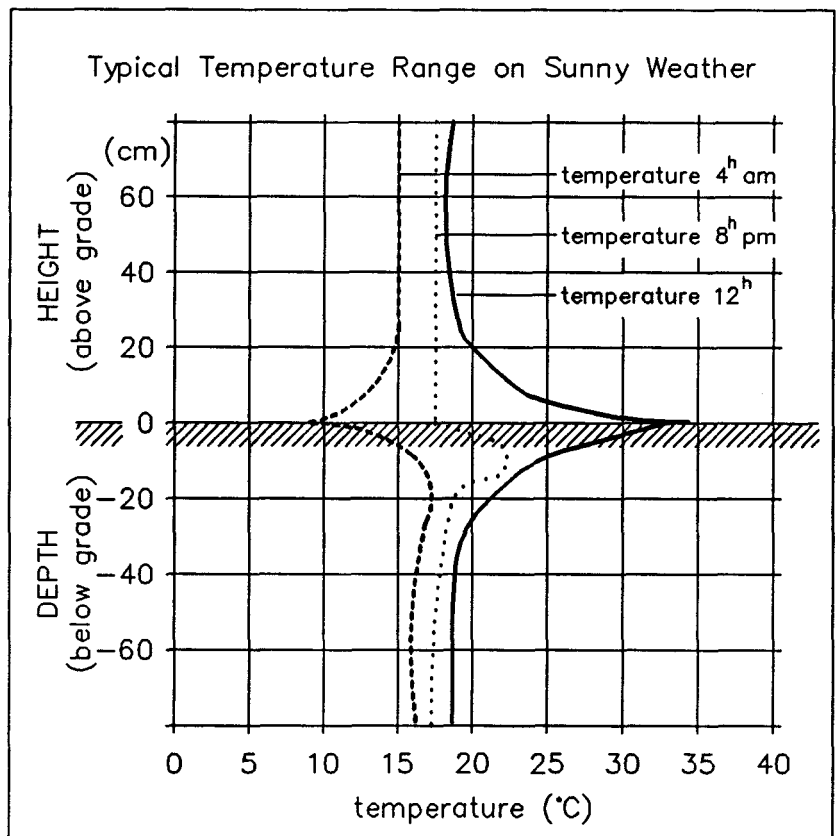
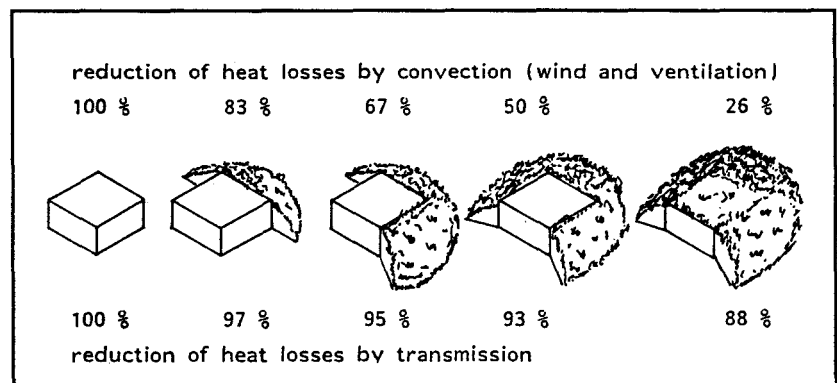

Figure 2.26  
Typical temperature range of soil depending on depth and daytime (after Geiger).

Figure 2.27  
Digging into the ground or banking up the soil around the building reduces the conductive and convective heat losses according to the covered area, the constitution of soil and piling height. Factors that should be considered carefully:

- disposition of floor plan
- egress
- building ventilation
- environmental building structure



# BUILDING ORGANIZATION

Other energy-related features of earth sheltered residences are lower infiltration losses (though minimized wind exposure) and high thermal capacitance. Concrete walls, floor, and ceiling increase the heat storage capacity for direct gain solar energy utilization.

The daily and annual fluctuations of air and soil temperatures are shown in figures 2.28 and 2.29, based on climatic features of the Minneapolis -St. Paul area:

Figure 2.29 shows that daily fluctuations are virtually eliminated even at a depth of 20 cm of soil. At greater depth, soil temperatures respond only to seasonal changes, and the temperature change occurs after considerable delay.

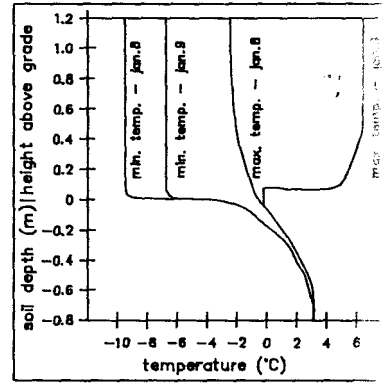
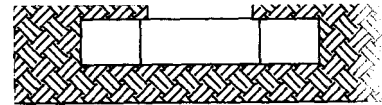
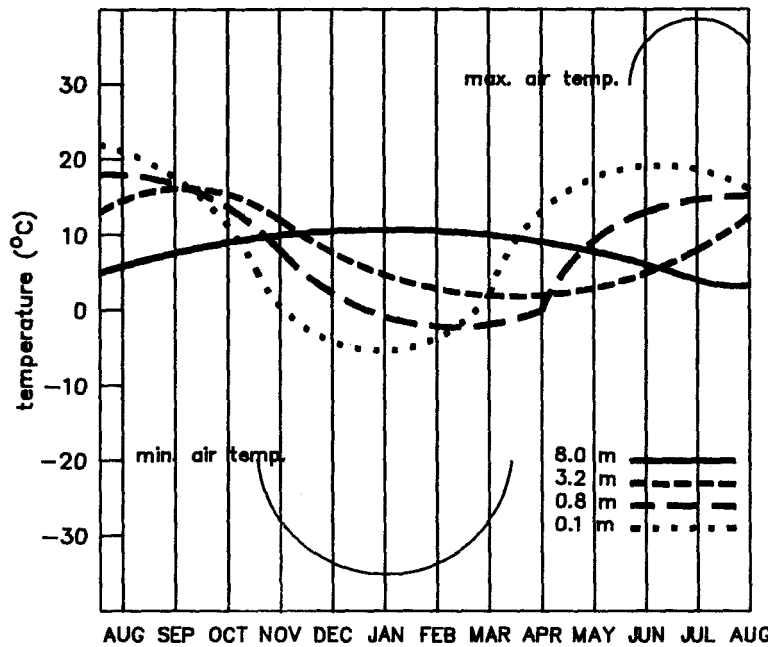
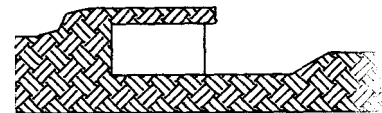

Figure 2.29

Figure 2.28 Seasonal temperature fluctuations at different depths. Here, where annually outside air temperature swings of 72 K - from -34 °C to 38 °C-occur, the temperature of the soil 5 to 8 m below the surface is virtually constant. 3m below the surface, the soil temperature varies from only 4 °C to 6 °C, and even immediately below the surface, the annual soil temperature range is only 22 °C.



flat site - fully recessed



flat site - semi recessed

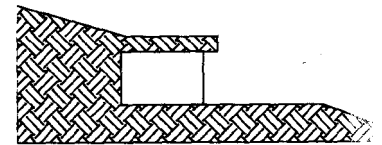

sloping site - one level

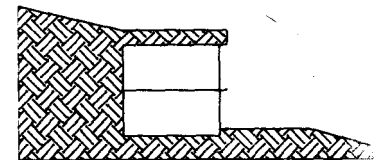

sloping site - two levels

Figure 2.30

MATERIAL	$\rho$ (kg /m <sup>3</sup> )	c (Wh/kg K)	$\lambda$ (W/m <sup>2</sup> K)	$b=\sqrt{\rho \cdot c \cdot \lambda}$
TUFF	1 600	0,25	0,55	14,83
LOAM, dry	2 500	0,22	0,40	14,83
SAND, dry	1 800	0,23	0,58	15,49
GRAVEL/CHIPS	1 800	0,23	0,81	18,31
SAND/GRAVELSAND	1 800	0,23	1,40	24,07
LOAM, wet	2 500	0,22	1,50	28,72
SOIL	2 100	0,25	2,10	33,20
CONCRETE	2 400	0,28	2,10	33,20
SEDIMENTARY ROCK	2 600	0,25	2,30	38,66
ROCK	2 700	0,22	2,90	41,50
CRYSTALLINE ROCK	2 800	0,25	3,50	49,49

Figure 2.31

Physical properties of different ground materials for evaluation of heat penetration.

- $\rho$  = specific gravity
- c = specif heat
- $\rho \cdot c$  = heat capacity
- $\lambda$  = heat conductivity
- b = heat penetration coefficient

## 2.5 Relation to Vegetation

Today, building developments often ignore the environmental flora and its potential energy-related effect. Historically, however, settlements and building sites were characterized by a climatic-adapted relationship to the specific location and its vegetation.

According to the kind, size, density, and growing conditions, plants can serve as protection from weather (wind, sun, and precipitation) or as an element for use of wind movement to ventilate the house in hot summer periods. Moreover, planting of windward slopes or ridges avoids erosion by wind and acts as a shelter for agricultural areas.

Slowing down the wind speed with vegetation will reduce convective heat losses. The motionless air padding of dense climbing vines on a building facade may be equivalent to a reduction of film coefficient from 25 to 10. With a lightweight masonry wall of 30 cm ( $U = 0.9$ ) the improvement of U-value is 5.5% ( $U = 0.86$ ). Related to a super-insulated wall ( $U = 0.3$ ), however, the improvement decreases to 1.8%, and heat losses may be reduced within a range of 5-10%.

Since vegetation takes time to grow, until it acts as an energy related component, existing vegetation on a site should be considered very carefully for possible integration into the design. New vegetation has to be harmonized with its specific demands concerning location, orientation, soil quality, and growing conditions.

Figure 2.32

Different effects of trees on solar shading: Depending on kind of trees, vegetation filters sunlight and protects against direct radiation. A complete obstruction to solar irradiation provides cool areas of shadow in summer, while deciduous trees allow solar penetration of crown in winter for solar gain.

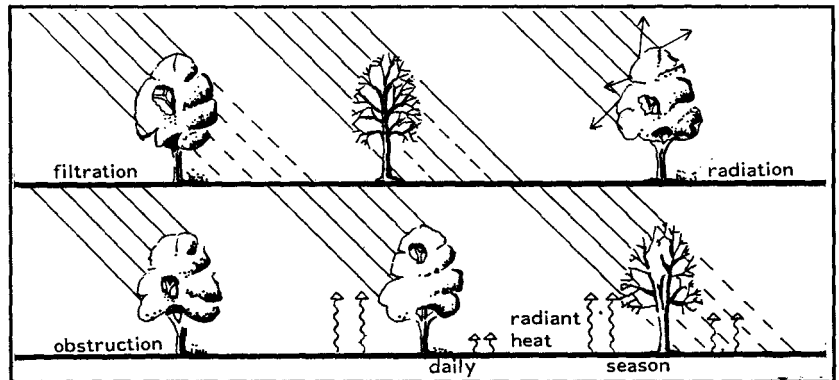
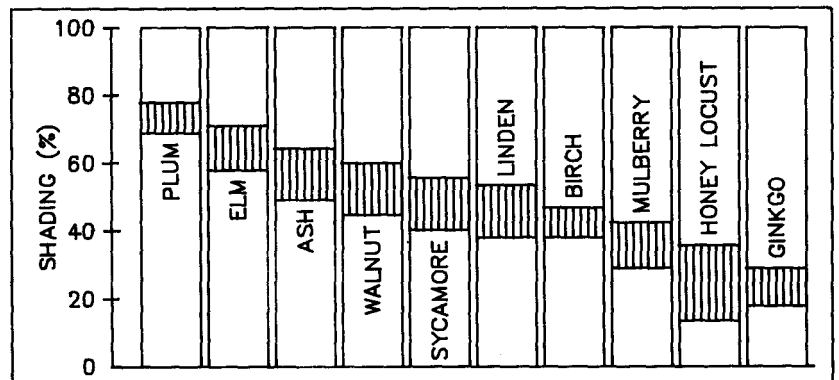

Figure 2.33

Capability of sunlight obstruction depending on various street trees: The shading effect of the bare branches in winter varies between 15% and 80% (lined areas) depending on thickness and density of the species.





# BUILDING ORGANIZATION

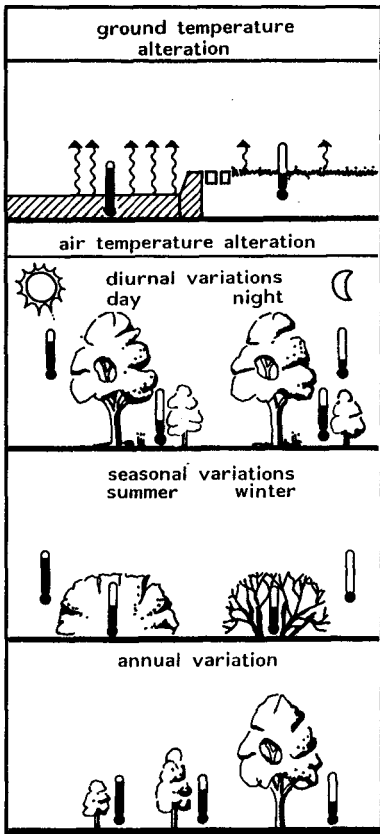

Figure 2.34

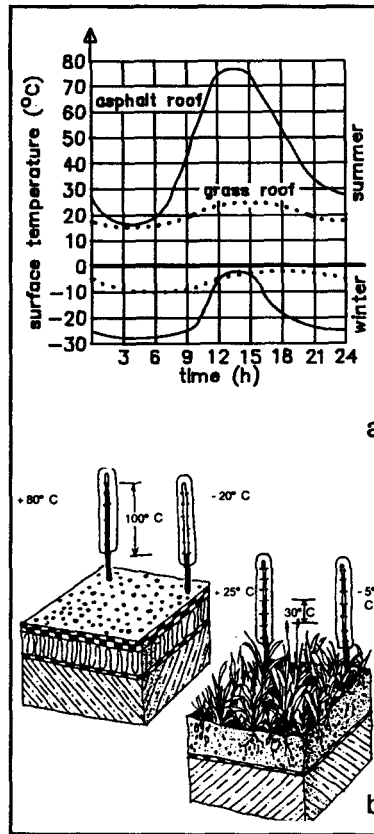
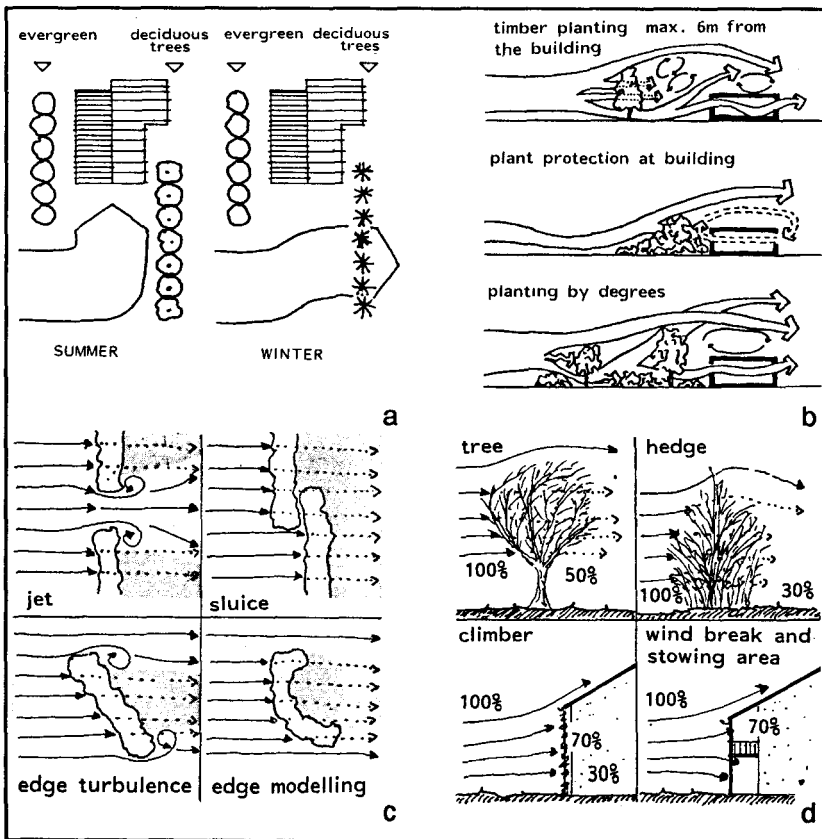

Figure 2.35

## Temperature Control

Figure 2.34  
Since vegetation controls solar radiation, it also controls temperature of ground and air in daily, in seasonal and, as growing, in annual variations. The effect of balancing the temperature swing can be dedicated to the roof of a building.

Figure 2.35  
Comparison of temperature ranges of an asphalt and a planted roof. The maximum seasonal temperature gradient of conventional flat roof may increase up to 100 K, while the "green roof" will decrease these loads to only 30 K.



## Wind Control

Figure 2.36  
Different types of barriers may provide various effects of wind control depending on their height, density and spacing relative to the building. Directing the air movement to the building, and reduction of wind speed, should carefully be considered according to the seasonal wind conditions at a given location. Wind protection and natural ventilation require the proper placement and screening of vegetation barriers in combinations to give the desired degree of control in specific situations.

# BUILDING ORGANIZATION

With the restricted availability of land for development in many countries, it will rarely be possible to select a site on the basis of optimum microclimatic features. Instead, a designer must do the best he or she can at optimizing bioclimatic planning on a predetermined site. Even unfavorable sites may be improved by means of ground contouring, use of water and vegetation, and the building construction itself. This is even possible within already built-up areas. Figure 2.37 indicates the relative heat loss of a building at various locations. Open location on plain country and unprotected exposure represents 100% and a temperature level of  $\pm 0^{\circ}\text{C}$ , ignoring convective heat losses by wind. Variations of mean temperature during the heating period at other locations will give an indication of different local climate features.

The actual microclimatic conditions are more complex and not easily defined because of their interdependencies. Nevertheless, typical topographical influences are variations in irradiation of slopes, nocturnal radiant heat loss and cold air currents. Depressions and other cold air gaps show up to 6 K lower temperatures, south facing slopes 2-3 K higher levels, northern slopes and exposed locations like hill tops (increased emission at night) 1-3 K lower.

Depending on proximity to woods and kind of vegetation, the natural protection creates different ambient microclimatic temperature variations of up to 5 K.

The microclimatic potential of water increases nocturnal temperatures. Idealized south slope locations near the lake surrounded by protecting vegetation may even allow subtropic plants in cooler continental climatic conditions.

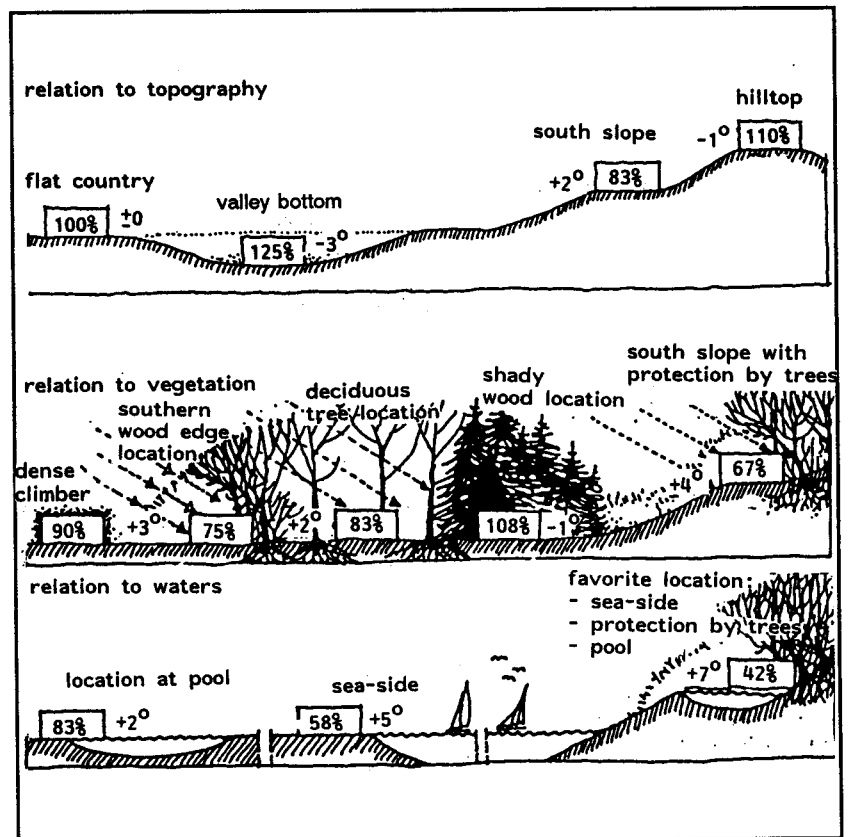

**Figure 2.37**  
Bioclimatic influences upon the heating demand of building location in relation to site and natural environmental features.

The reference case is the flat country location representing a heat demand of 100%. Other locations may increase or reduce the numbers by temperature variations, wind protection, solar exposure and other microclimatic influences.

Since a house can be viewed as an organism, the human body itself gives helpful advice about energy principles of heat production, its distribution and different kinds of transmission and dissipation (see Booklet 1, Energy Design Principles in Buildings).

Independent of outdoor climate conditions, the core temperature of the body must be maintained at 37°C. Heat production by muscle movement and food metabolism are the heat sources. Surface temperatures of the body differ with their function and ambient conditions. Heat exchange with the environment will control the ratios of heat transmission by convective cooling, evaporation (sweating), conduction, and emission (radiation). Clothing will protect the body from heat losses in winter. On the other hand, the same clothes will lead to a higher ratio of evaporation in summer because heat exchange does not occur by emission (see also section 4.1, Thermal Comfort).

The better the heat buffering, the lower the effort of the human body to regulate and control physiological needs.

Energy conscious building design should use these same principles within the building. For climates that require heating for much of the year, the zoning of floor plan and disposition of spaces due to their recommended temperature should create a temperature hierarchy from the core of the building to the ambient conditions. Rooms of equal heat requirements should adjoin each other and enclose the heart of a house like a belt.

Conversely, for climates that require cooling for most of the year, a zoning strategy should provide shading areas around the building, and sufficient ventilation of the entire floor area (see figure 2.39 on page 44).

## 2.6 Zoning Principle

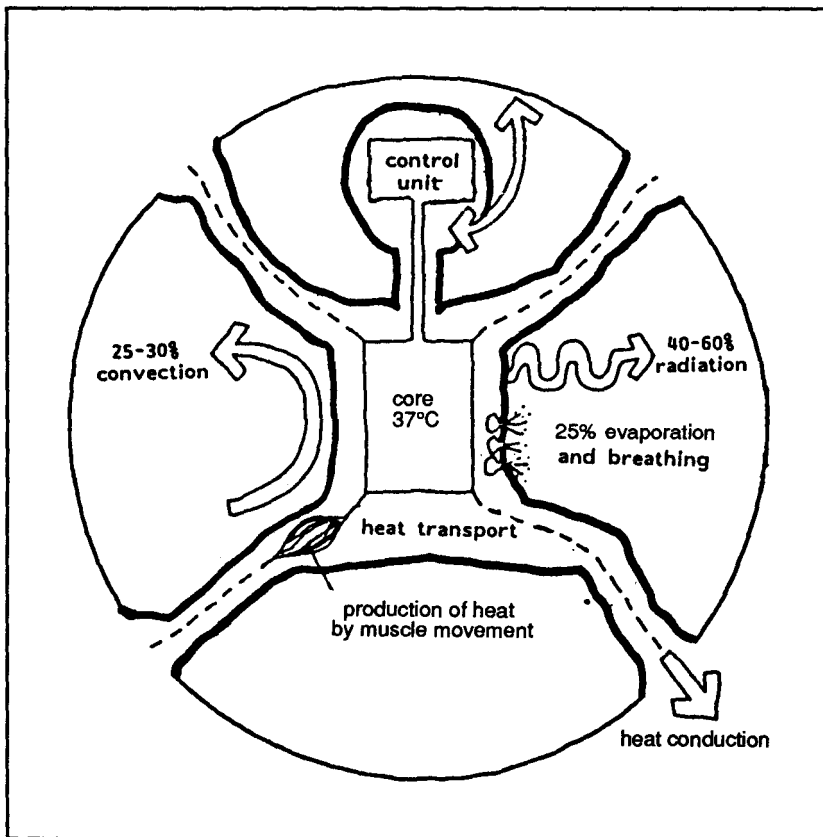
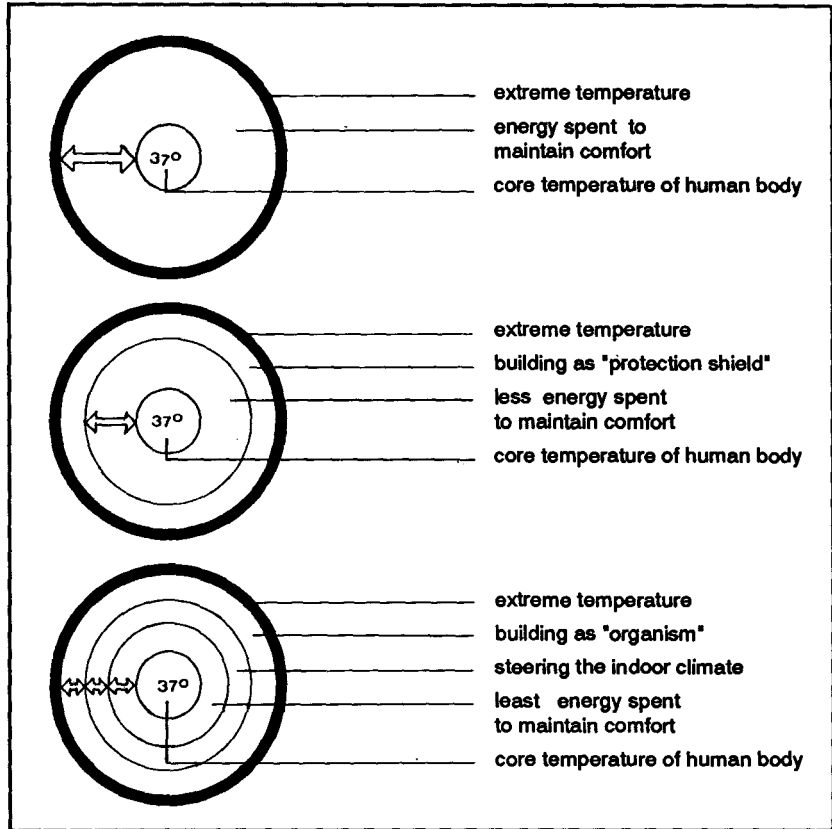

**Figure 2.38**  
Heat transmission of the human body:

The fraction of heat transmission varies depending on man's activity and ambient climatic conditions.

At 20 °C room temperature and 50% relative humidity, a man 1,80 m tall, 75 kg weight realizes a body surface area of 2 m<sup>2</sup>. His heat transmission counts 100 W (50 W/m<sup>2</sup>) in sitting position and 300 W (150 W/m<sup>2</sup>) when working (for more detailed information see section 4.1, Thermal Comfort).

## Temperature Hierarchy



**Figure 2.39**

The effort expended by a human body to maintain thermal comfort depends essentially on ambient air temperature conditions. A building serves as a thermal protector against extreme temperature fluctuations. If a building is organized as a balancing organism with buffer spaces, the body will require less energy to stay comfortable.

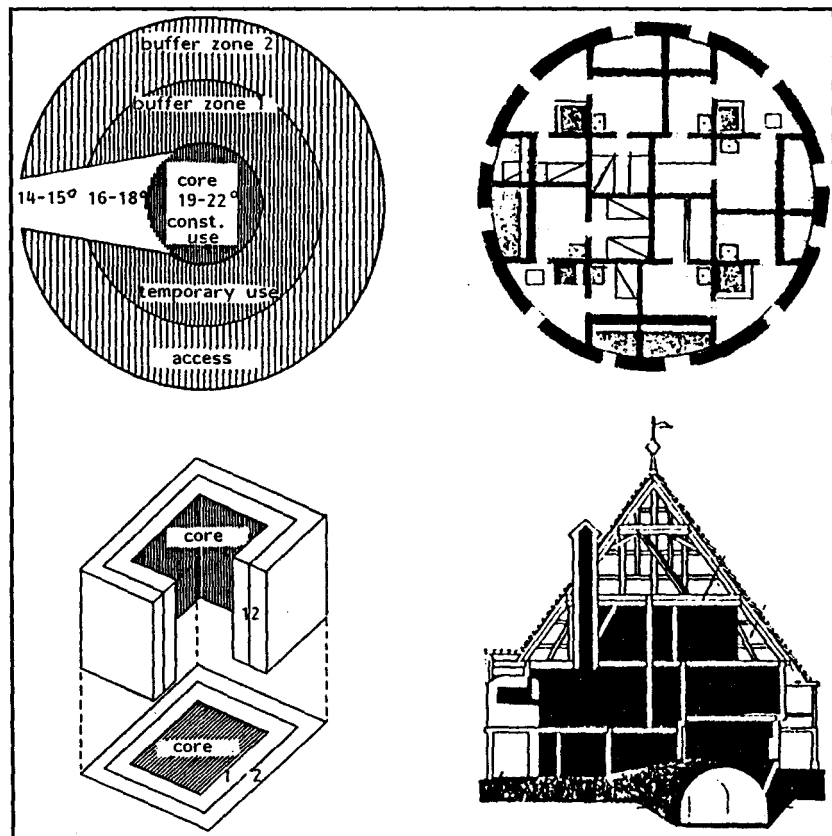

**Figure 2.40**

Zoning principles determine the floor plan and building concept in the very early pre-design stage. An analysis of the space program is necessary to create a temperature hierarchy to transfer zoning into a realistic design concept.

# BUILDING ORGANIZATION

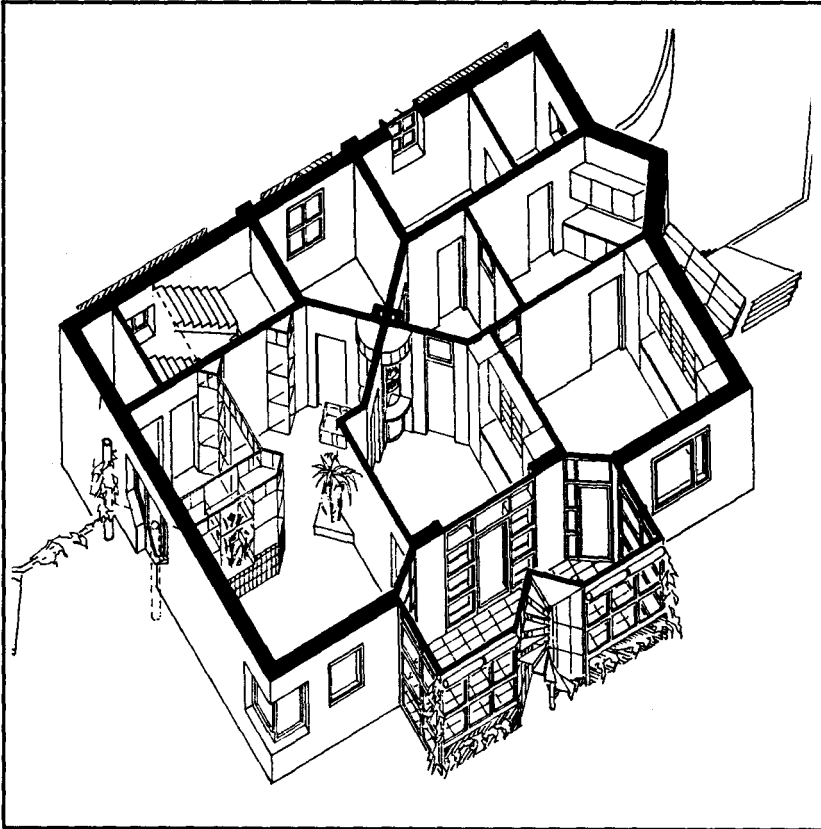

Figure 2.41

Figure 2.41-2.42 Detached home:

The center of the house is represented by a heat core surrounded by living rooms. Secondary rooms and circulation areas are northern buffers. Southern buffer space by a sunspace for temporary use and solar heat gain for the living rooms at the second floor.

Design: Günther Ludewig, Berlin

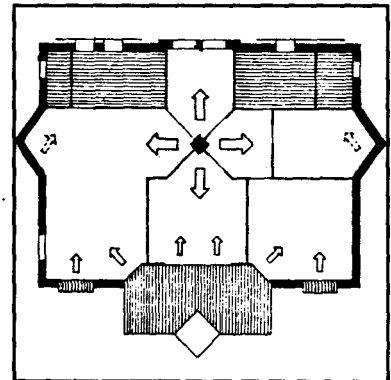

Figure 2.42

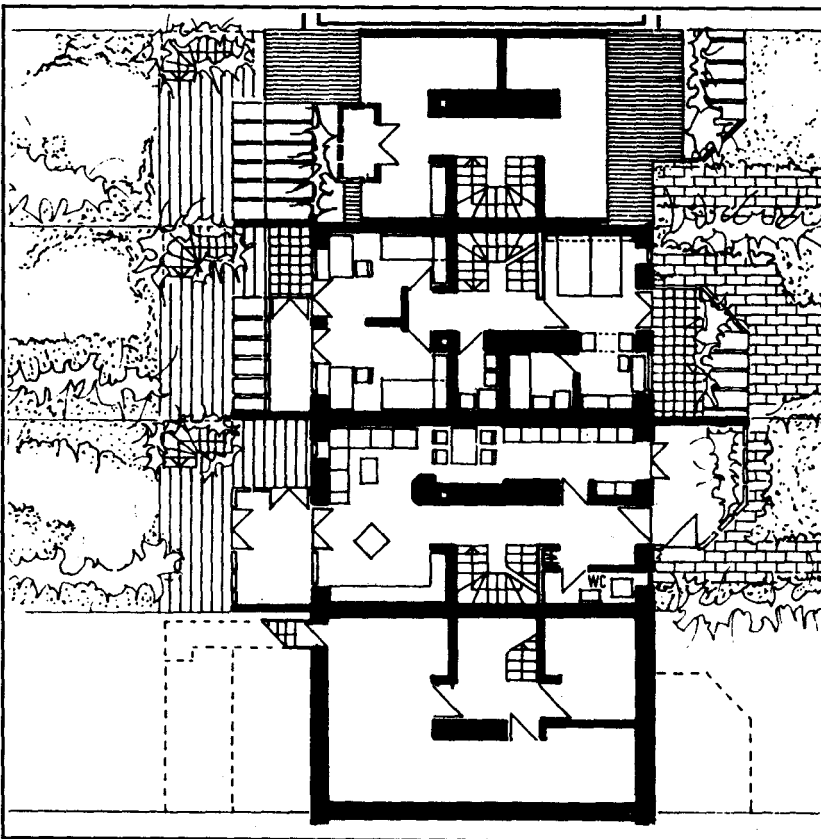

Figure 2.43

Figure 2.43-2.44 Row house:

The building organisation consists of horizontally and vertically thermal cascading zones from the heart to the outside

Design: Günter Löhnert, IBUS, Berlin

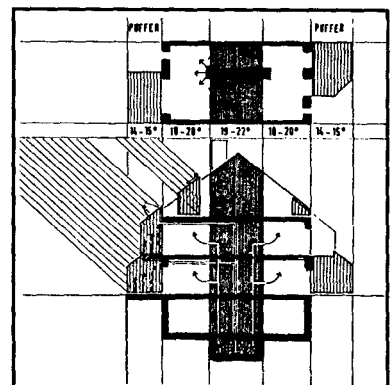

Figure 2.44

# BUILDING ORGANIZATION

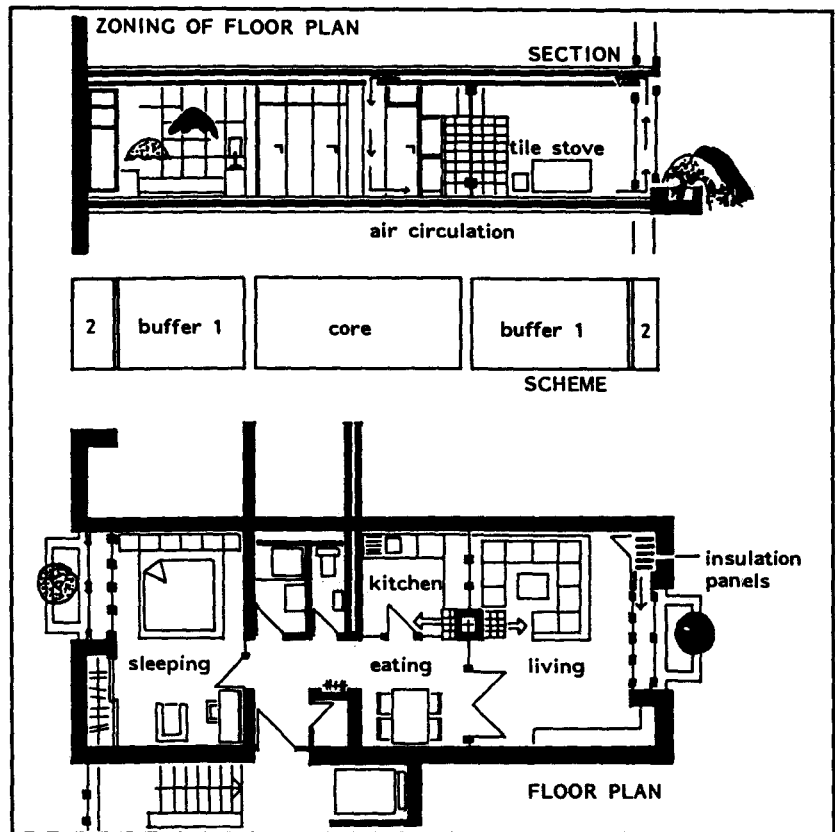

Figure 2.45 Multi-story Building Design

The location of spaces follows a temperature hierarchy. The area of exterior wall shows a series of different buffer: the insulated wall, double flower window and boards containing movable insulation for the window area. Flexible floor plan between dining and living area by glazed partition. The warmest areas (kitchen, bathroom) are the heat core of the apartment.

Design: Günter Löhnert, Berlin

Figure 2.46 Dense Row House Structure

This special concept of densely built houses results in a variety of temperature zones which allow various space use.

A varied development, partly open, partly glazed, covers the entire site, leaving intermittent spaces for public use. The individual units consist of various zones:

- The interior stone house as actual living quarters (winter house)
- The adjoining glazed zone as additional living sun space (glass house)
- The garden zone for outside activities
- The light house as pedestrian access
- The glasshouse that captures the sun is located in front of the stone house which acts as heat storage
- The greenhouse in front of the glass house is covered with deciduous plants and provides a stable microclimate (wind and weather protection)

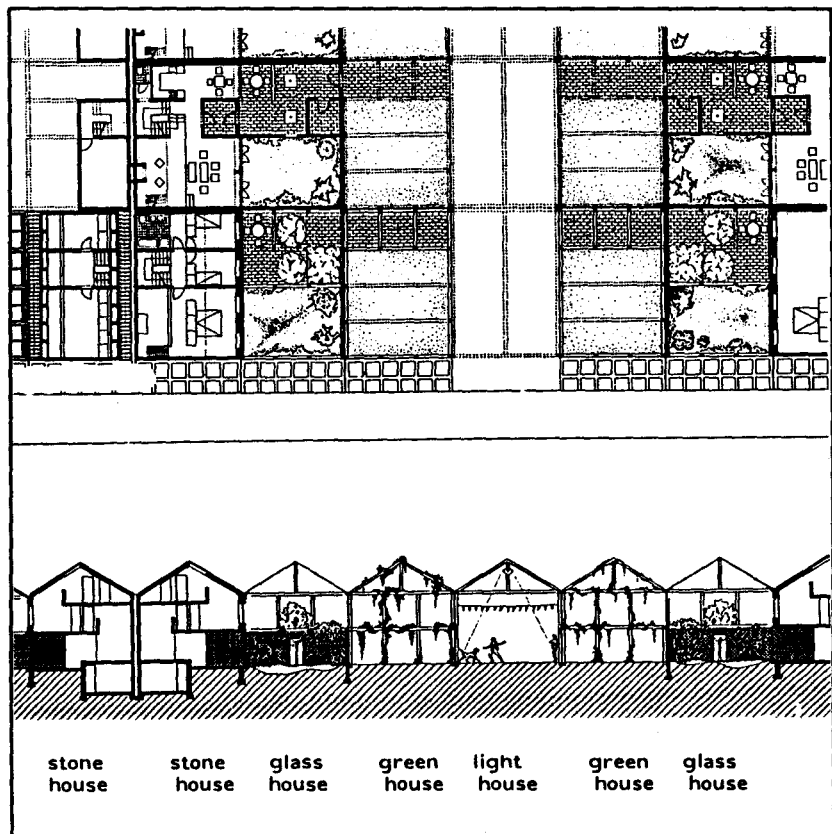

# BUILDING ORGANIZATION

The thermal effect of a buffer space is characterized by an intermediate air temperature between indoors and outdoors. Thus, the heat transfer from the inside to the buffer decreases. The buffer space temperature depends on two thermal qualities: the U-value of the internal partition wall (between room and buffer) and the U-value of the external envelope (between buffer and outside). The relative temperature differences (see equation below) defines the buffer space coefficient 'b', which determines the relative improvement of thermal quality of the partition wall caused by the buffer. The buffer space temperature is determined by the equation of heat losses from the room to the buffer and to the outside, and is equal to those from the room to the outside (see figure 2.47).

## 2.7 Buffer Space Effect

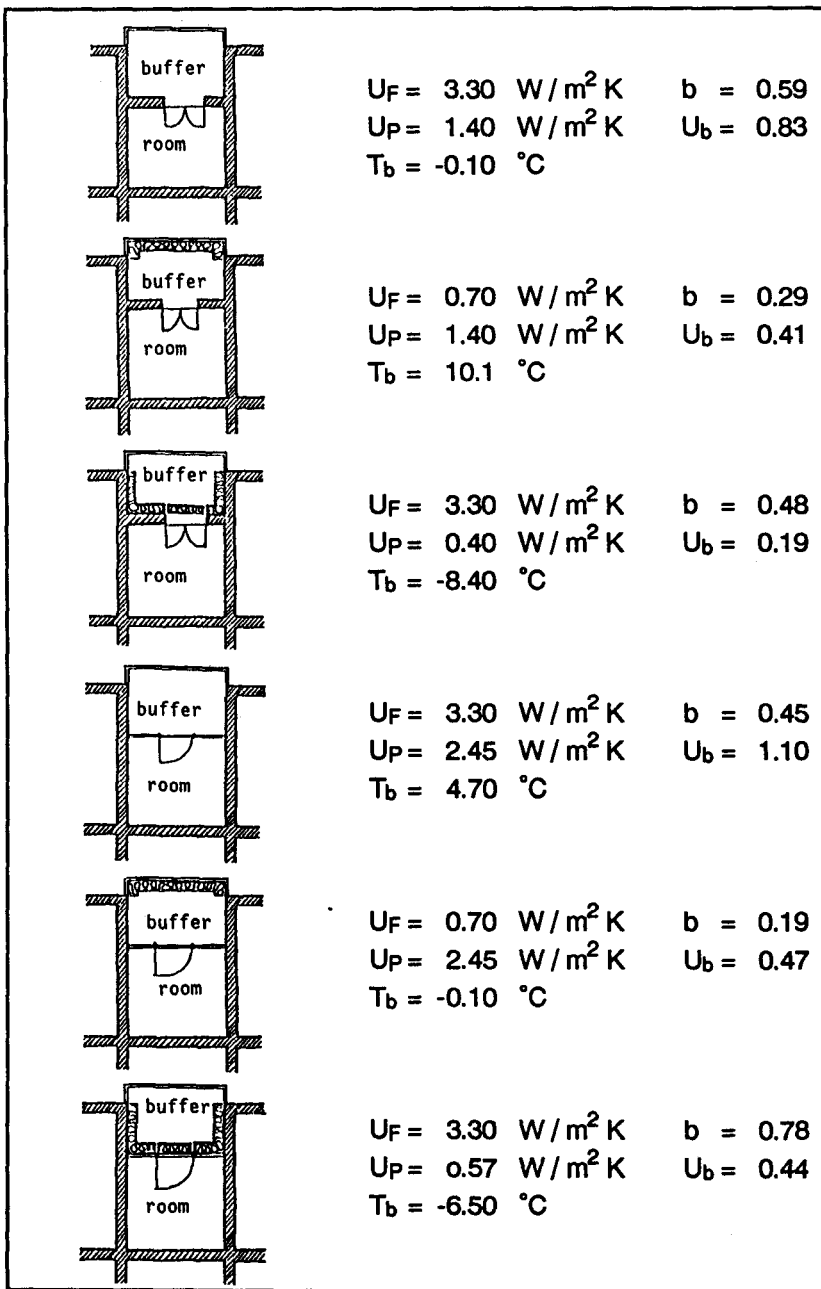

Figure 2.47

Buffer Space Coefficient Depending on Temperatures (stationary consideration without regard to solar gain).

$$b = \frac{T_r - T_b}{T_r - T_a}$$

$T_r$  = room temperature ( $^\circ\text{C}$ )

$T_b$  = buffer temperature ( $^\circ\text{C}$ )

$T_a$  = ambient temperature ( $^\circ\text{C}$ )

$U_F$  = U-value of facade

$U_P$  = U-value of partition wall

$U_b$  = U-value of total buffer

=  $b \times U_P$

temperature conditions of considered case:

room temperature  $T_r = 20 \text{ }^\circ\text{C}$

ambient temperature  $T_a = -14 \text{ }^\circ\text{C}$

$T_r$  = room temperature

$T_b$  = buffer temperature

$T_a$  = ambient temperature

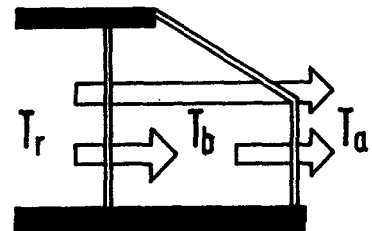

Principle of Buffer Space Consideration

# BUILDING ORGANIZATION

## Buffer Space Configurations

Depending on available space and overall building organization, buffer spaces can be set aside to create an intermediate climate between indoors and outdoors. Buffer zones act as thermal membranes, balancing temperature differences and stimulating occupants' activities according to climatic conditions.

Given possible problems relating to orientation, especially when facing the sun, the areas to be glazed should be selected carefully. Buffer spaces should be integrated into the building envelope to improve "Area-to-Volume" ratio but not to hurt daylighting. Buffer spaces may easily be attached to existing buildings, extending the living area temporarily. In many cases, those room extensions are not restricted by building codes if they are defined as either secondary spaces, or unheated greenhouses.

**Figure 2.49**  
Variations of buffer spaces according to use, size, and building integration

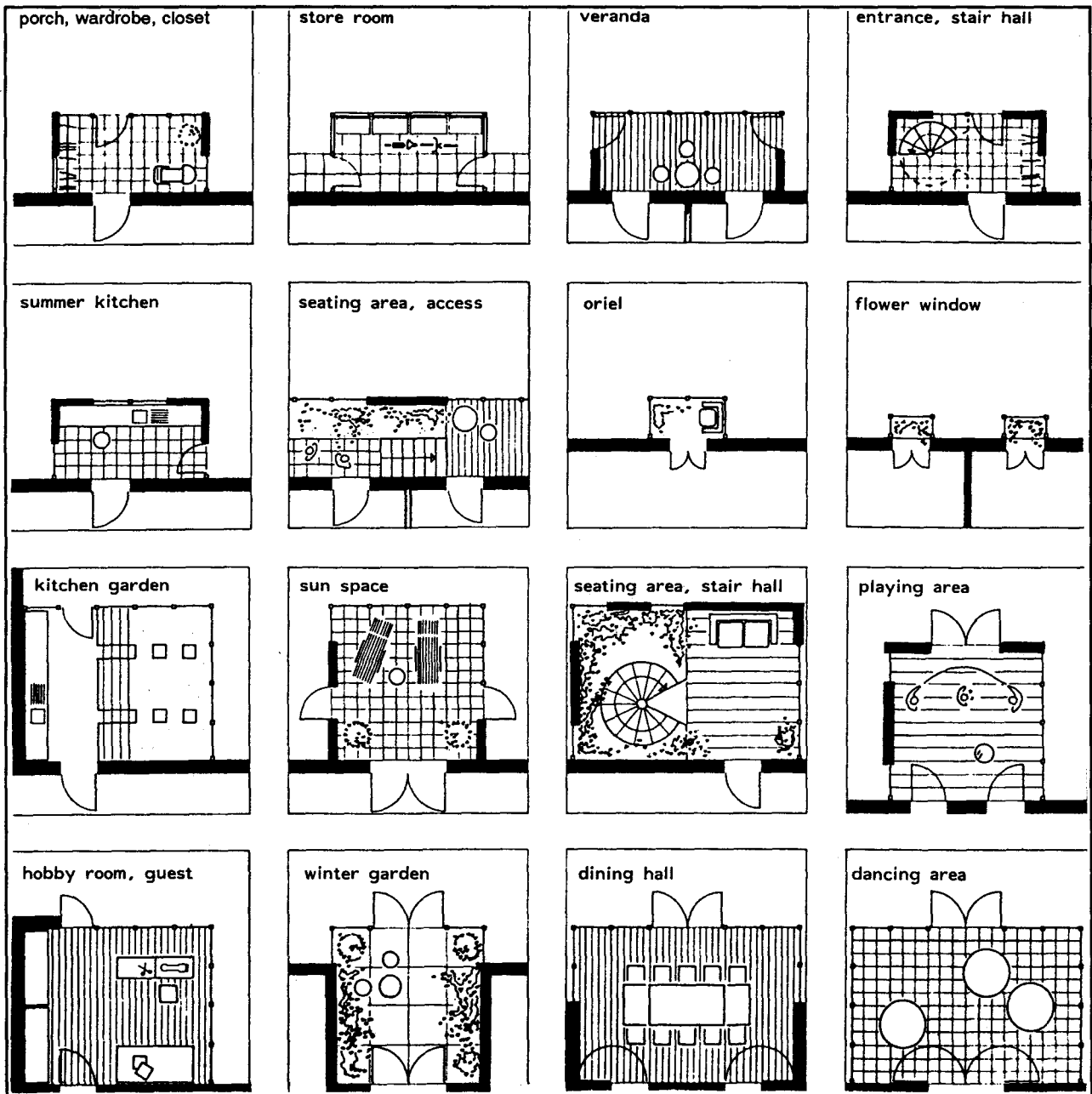



As used here, the term "building system" refers to the structure, exterior envelope, interior partitions and floors, windows, insulation materials, shading devices and other elements that create the building shell and define interior space. The manner in which these building elements are configured determines the thermal capacitance of the building, its heat gain and loss characteristics and the type of passive solar system. Many factors will determine the most appropriate building system for a specific project including client needs, designer preference, site requirements construction budget, available materials, traditional construction practice, and marketing considerations.

This chapter discusses a range of options and factors to consider when selecting the building structure, insulation, glazing, shading and passive solar system. The unique circumstances of a project will determine the appropriate design choice of these building system elements.

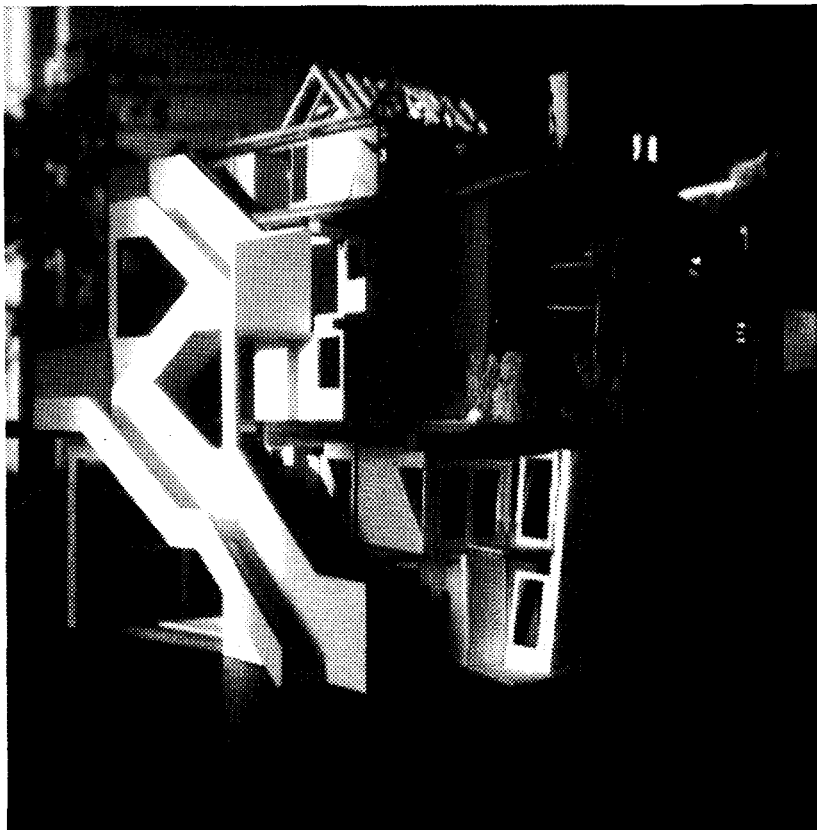

*Figure 3.0*  
'Öko-Haus' project in the city area of Berlin, F.R. of Germany.

A skeleton concrete building structure providing spaces for the integration of individual two-story residences on each platform. The design objectives for the 18 private homes represented by 9 independent architects also required bioclimatic approaches and energy and ecology -related integration.

Concept of concrete structure: F. Otto

Design architects:  
D. Dörschner  
E. Haas  
H. Kendel  
M. Kuenzlen  
G. Ludwig / G. Löhnert  
J. Rohrbach  
M. Ruprecht  
U. Schulte-Lehnert  
P. Stürzebecher

# BUILDING SYSTEM OPTIONS

---

## Checklist

### Building Structure

- Identify any functional or site-specific requirements that may dictate the primary structure of the building
- Define the application of building material according to its physical properties:
  - storage capacity
  - thermal performance
  - structural capacity
  - durability/reliability

### Building Components

- Assess the limitations of thermal requirements upon building components:
  - maximum heat transfer
  - recommended insulation levels
- Define the ratio and areas of glazing according to site-specific requirements of the design:
  - sizing of glazing area
  - orientation/slope
  - thermal quality
  - glazing material
  - glazing structure
- Determine passive solar strategies according to requirements for:
  - year round comfort
  - utility peak
  - energy conservation
  - solar collection
  - heat storage
  - heat distribution
  - sun protection
  - passive cooling
  - natural ventilation
  - domestic hot water
  - daylighting

# BUILDING SYSTEM OPTIONS

Because building components can act as heat collectors, absorbers, distributors, storage or combinations, the choice of building material to prevent overheating in summer and to maintain thermal comfort in winter for the occupants should be considered by the designer. Older buildings were mainly constructed of heavy materials, especially those in moderate and hot dry climates. Thermal mass or capacitance, the property of density, may have a positive effect on building energy consumption, and its amount can be as important as insulation in the conservation of energy.

High mass construction is characterized by the ability to store heat and a large inertia which is responsible for slow adaptation to temperature change. Depending on climate, the use of the room, and the heating system (strategy), this could be desirable.

The ability of mass to delay the effect of the outdoor temperature cycle can be as important or sometimes even more decisive than the necessity to resist heat flow by insulation materials. In a climate with large day-night temperature gradients, buildings with no mass could require heating energy at night, and cooling during daytime. With mass and an optimum of 12 hour delay, the building in such a climate could store solar energy during the day and use it to provide heat at night.

Every building material has the ability to both resist and delay energy flow. The degree of one of those characteristics is always different. Concrete or brick can absorb more heat but are unsuitable for insulation purpose because of their high conductivity. Conversely, insulation materials, like fiberglass or mineral wool, resist the heat flow (low conductivity) but also do not absorb, store or delay the heat flow.

## 3.1 Building Structure and Thermal Mass

Figure 3.2

Reduction of 20 °C indoor temperature level (outdoor 0 °C), in hours, depending on building construction:  
 Even a badly insulated mass wall will keep heat twice as long in comparison to super-insulated lightweight construction. The same super insulated wall will reach the level of 14.2°C within 18 hours. A super-insulated mass wall will take four-fold time, 72 hours. However, it takes longer to heat up a space surrounded by mass walls which have dropped below the comfort range.

Thermal characteristics of selected building materials: Since heat storage capacity (Wh/kg K) is the product of specific gravity (kg/m<sup>3</sup>) and specific heat (Wh/kg K), the table illustrates that water, for example, has nearly twofold greater storage capacity than reinforced concrete, though its specific gravity is only half. Responsible for this is the almost fourfold greater specific heat of water. Taking into consideration of costs, suitability for construction and weight, concrete fulfills many of these requirements.

Materials at 20°C	Specific Gravity (kg/m <sup>3</sup> )	x Spec.heat (Wh/kgK)	= Storage Capacity (Wh/m <sup>3</sup> K)	Conductivity (W/mK)
air	1.2	0.28	0.4	0.02
fibrous glass	120	0.23	28	0.04
wood	600	0.46	276	0.14
exp.cinder concrete	1000	0.29	290	0.35
oak wood	800	0.43	348	0.21
sand, dry	1500	0.23	348	0.58
earth, dry	1000-2000	0.23	230-700	0.17-0.58
brick	1700	0.23	397	0.75
cement mortar	2000	0.24	484	1.40
reinforced concrete	2200	0.30	660	1.56
natural stone	3100	0.23	730	3.48
cooper	9000	0.10	900	348.00
steel	7800	0.13	1020	58.00
iron	7250	0.15	1093	58.00
water	1000	1.16	1160	0.58

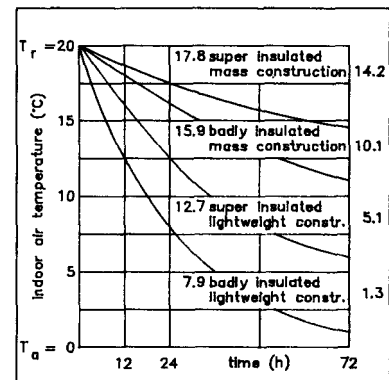

Figure 3.1

Physical properties of selected building materials.

## Time Lag

Since mass is very hard to control - you cannot turn it on or off - the consequences of mass construction have to be considered very early in the design process. Care should be taken when selecting quantities of mass and insulation material for a specific climate and building type. Information about the annual temperature patterns for outdoor and indoor design conditions should be obtained. As indoor climate requirements may differ from outdoor conditions, an ideal building envelope has to balance these two forces to provide thermal comfort, save energy, and minimize the expense of mechanical HVAC systems.

The thermal performance of a wall is determined by its energy resistance (U-value), its energy capacity (time lag) and its energy diffusion (decrement factor. The surface temperatures of theoretically "thermal neutral" wall construction would cycle around a certain average temperature level based on the ambient temperature variations during day and night (see figure 3.3, graph 1). Presuming that the "average" line is also the neutral zone of energy consumption, the area above the line represents an environmental energy input and the area below the line indicates the period of energy demand. Accordingly the U-value of a wall restricts heat flow (2) while time lag (depending on thermal conductance and energy capacity) will delay the energy input (+) and demand (-) by a certain interval (3). The decrement factor (4) or energy diffusion can be explained as a change of indoor temperature directly related to time lag as, the wall stores ambient thermal energy during daytime. At night, when the wall is warmer than the outdoor temperature some of the heat will be conducted to the exterior without effect upon the indoor wall surface temperature. A composite wall of mass and insulation therefore reduces heat loads and temperature swings (5).

**Figure 3.3**  
Thermal performance of a wall considering U-value, time lag, and decrement factor related to a 36-hour cycle.

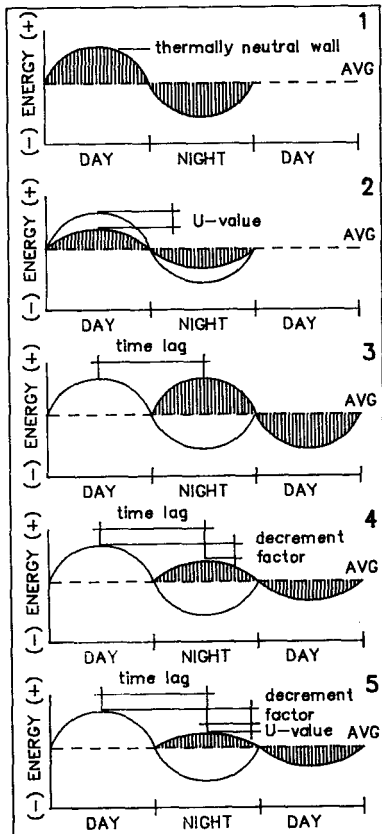

**Figure 3.4** Different indoor climates depending on building construction: The degree and kind of storage mass in concert with the ratio of exterior envelope and orientation create different indoor climates according to the different thermal responses upon ambient weather conditions. Good building concepts provide an ideal climate due to the specific space use requirements.

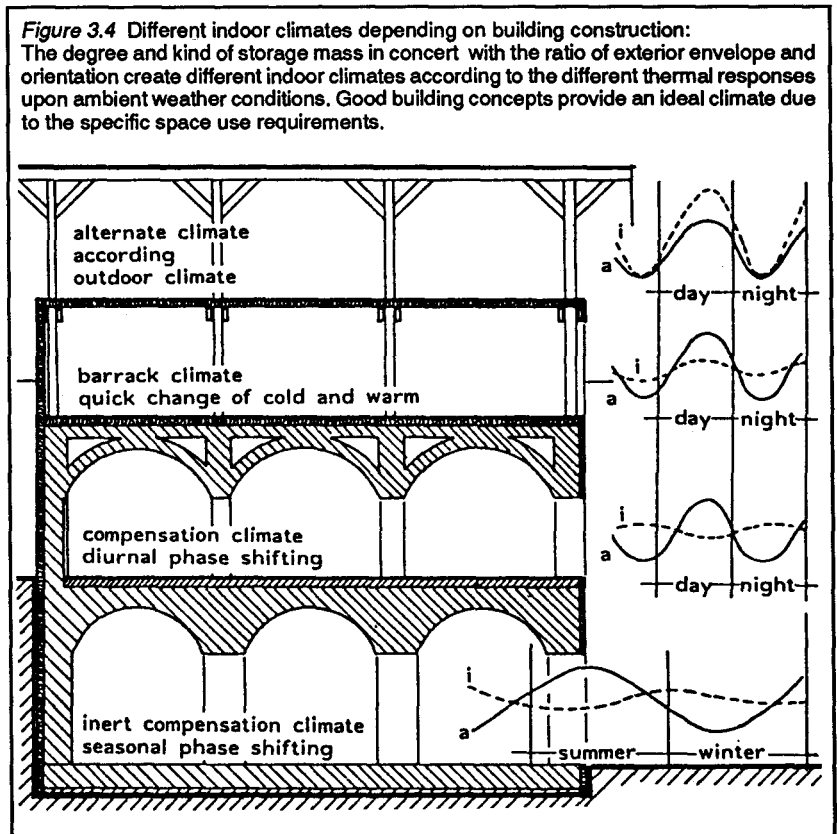

# BUILDING SYSTEM OPTIONS

When designing a wall, the challenge lies in deciding how to incorporate both mass insulation materials. The placement of insulation can have a great effect on a wall's time lag component. Placing insulation on the outside and mass on the inside is typically the best way to dampen interior temperature variations. However, with different usage pattern of indoor spaces, this may not always be the best design.

**Example 1:** In a hot and dry climate which experiences high temperature swings between day and night, thermal mass will equalize indoor and outdoor climate by the effect of time lag (see figure 3.4).

**Example 2:** A room which is used only temporarily can be heated up very quickly to maintain thermal comfort. In this case a low mass, or lightweight construction with high insulation levels, is more advantageous for energy economy.

**Example 3:** A space that is occupied regularly requires a steady temperature level of surrounding surfaces to maintain thermal comfort. In this case, thermal mass is desirable since the inertia of storage mass avoids cooling down.

On the other hand, a critical temperature level (cold or overheating) could not be equalized very quickly by heating or cooling.

These simplified examples show that storage capacity may be evaluated as advantageous as or disadvantageous as, depending on different determinants and requirements. Therefore, the designer's choice of some combination of mass and insulation must be balanced by consideration of the passive solar system selected, the intended usage pattern for a building and the specific local climate conditions.

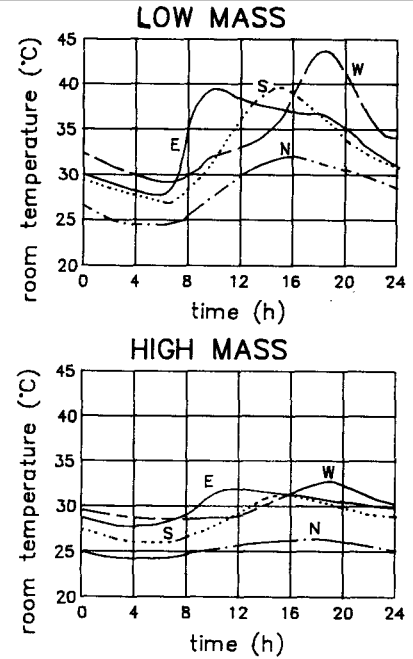

**Figure 3.5**  
Diurnal temperature performance of a low mass and a high mass construction depending on different orientations.

**Figure 3.6**  
Storage effect of mass building components.

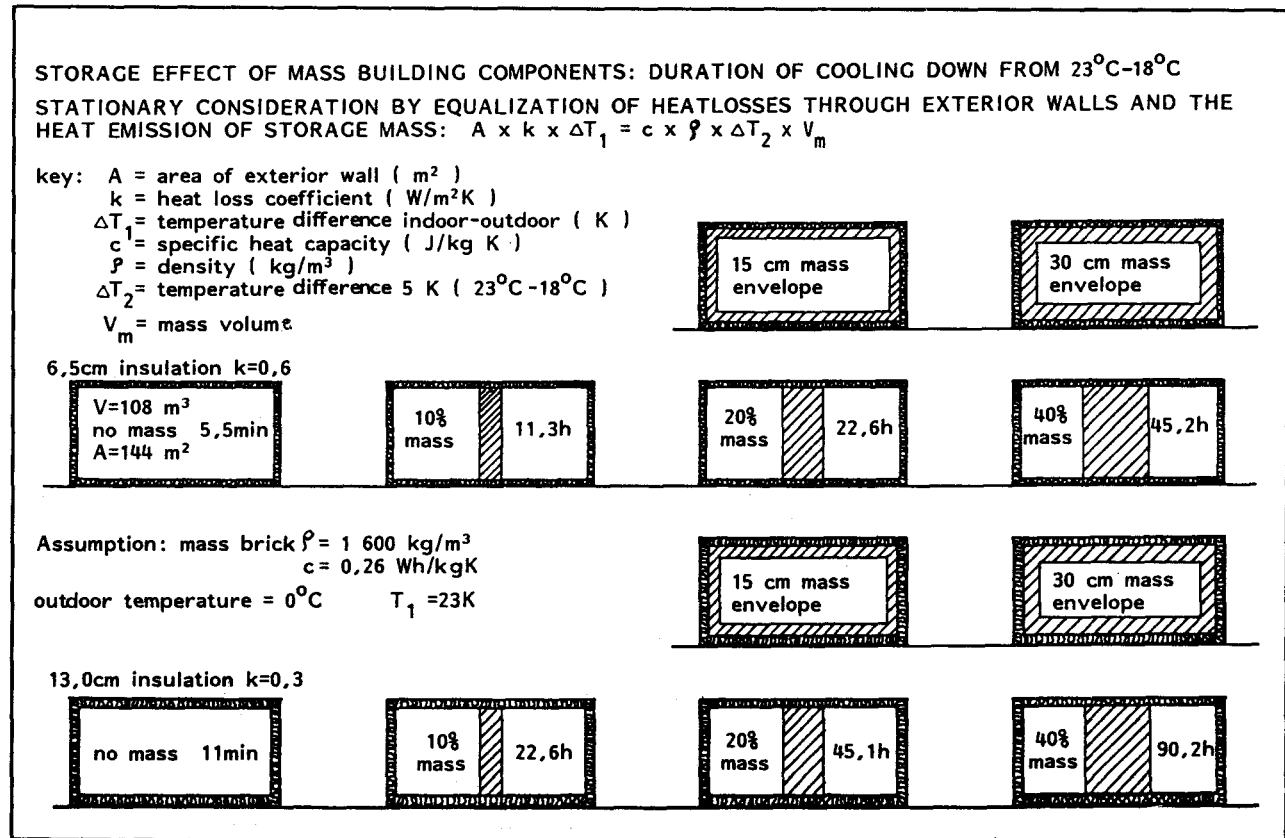

# BUILDING SYSTEM OPTIONS

## 3.2 Insulation

The thermal quality of the building envelope directly determines the heat losses, represented by transmission losses through external building components and infiltration losses through openings and cracks. Therefore, the heat demand of a building depends on insulation materials of the exposed surfaces and the temperature difference between outdoors and indoors. An improvement of insulation levels is equivalent to a reduction of the length of the heating season. The efficiency of passive solar systems increases according to the insulation level, and a well-insulated wall is usually a very energy- and cost-effective way to improve the heat balance of a building.

In comparison to an uninsulated massive wall, a well-insulated wall will have a higher interior surface temperature. This effect results in a

**Figure 3.7**  
Impact of increased insulation on length of heating season.

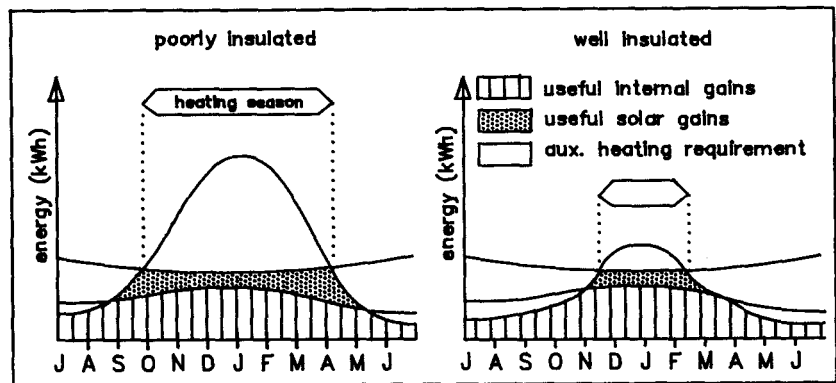

**Figure 3.8**  
Climate-dependent requirements on the U-value to achieve certain interior wall surface temperature.

wall surface temperature (°C)	Hot Arid	Hot Humid	Temp.	Cold
	23	0.40	0.34	0.23
22	0.51	0.45	0.34	0.28
21	0.85	0.74	0.57	0.51
20	1.14	1.02	0.79	0.68
19	1.53	1.36	1.02	0.91
18	1.93	1.70	1.19	1.08
17	2.27	2.04	1.48	1.31
16	2.25	2.27	1.70	1.48

for ceilings, the U-values decreases 15%

1 m	2 m	3 m	MATERIAL	$\lambda$ (W/m K)
0,10			POLYURETHANE FOAM	0,03
0,12			GLASS WOOL	0,04
0,175			CORKBOARD	0,05
0,315			WOOD WOOL SLAP	0,09
0,49			WOOD	0,14
0,70			GAS CONCRETE	0,20
1,225			LIGHT BRICK	0,35
1,65			LIGHT LOAM	0,47
1,75			LIGHT CONCRETE	0,50
2,10			BRICK 1 400 kg/m <sup>3</sup>	0,60
2,77			BRICK 1 800 kg/m <sup>3</sup>	0,79
3,46			SOLID SAND-LIME BRICK	0,99
7,35			CONCRETE	2,10

**Figure 3.9**  
The effectiveness of insulation materials depend on their conductivity ( $\lambda$ ) and the applied thickness. A comparison of different materials shows their suitability related to equal thermal insulation levels.

Example: A 10 cm PU-foam insulation and a light brick wall of 122 cm thickness provide equivalent insulating value

# BUILDING SYSTEM OPTIONS

comfortable indoor climate by increased mean radiant indoor temperature (see section 4.1, Thermal Comfort). While the location of the insulation layer has no influence on the heat transmission (U-value), exterior insulation improves comfort if the storage mass exposed to the inside. Another advantage is the decreased risk of structural damage caused by condensation. During cold weather, condensation can be caused by the fall in temperature (saturation point) inside the wall construction when the insulation is inside (see figure 3.10). Thus, interior insulation should only be used in exceptional cases or in rooms dedicated for occasional use (more detailed information see Booklet 5, Construction Issues). Translucent insulation combines passive solar gain by mass walls, and super insulation of exterior walls, restricting the heat flow to the ambient air. Overheating arises when the areas are not shaded in summer.

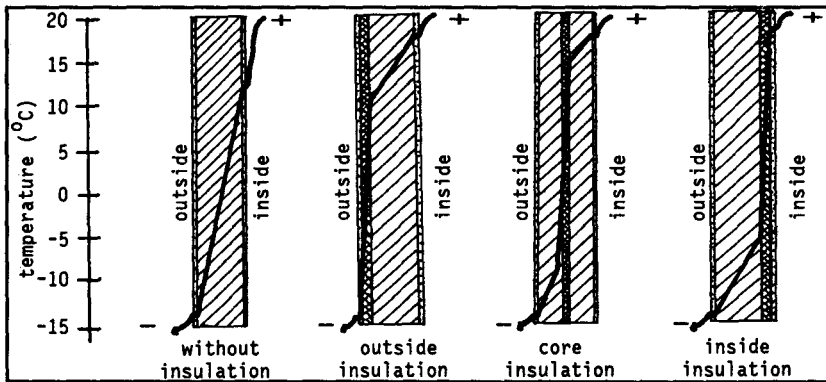

Figure 3.10  
Temperature development of an exterior wall due to the location of insulation, air temperature relation 20 °C / -15 °C.

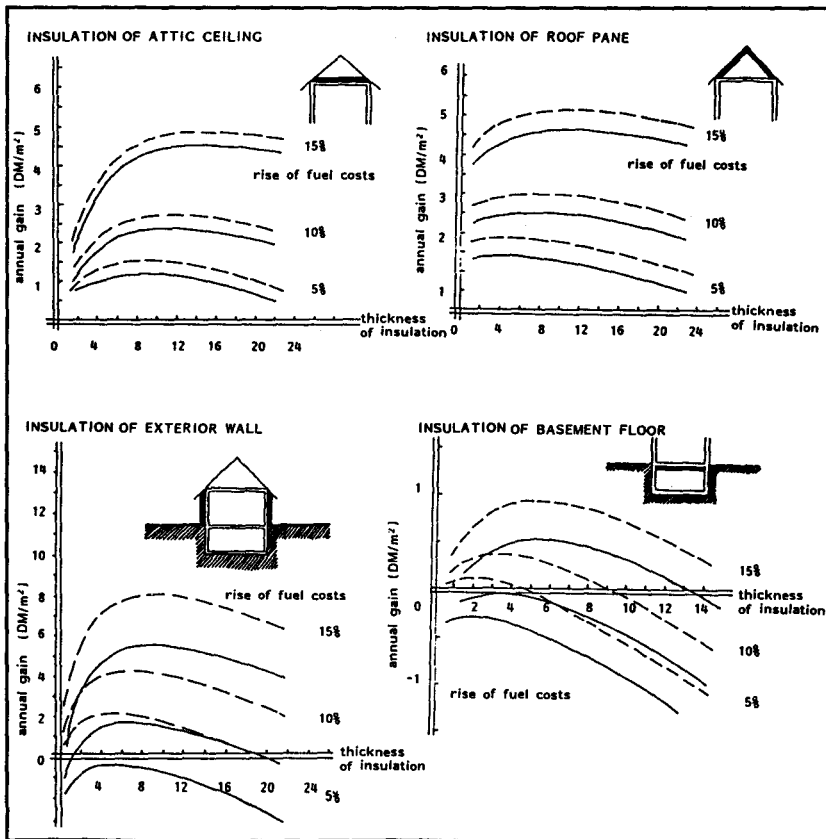

Figure 3.11  
Cost savings dependent on thickness of insulation:

The peak of each graph shows the relative optimum of economy related to the different building components as a function of fuel costs.

The dashed line indicates the costs of material plus workmanship.

This graph represents an investigation considering German costs and market conditions. Nevertheless, it shows the principle that an economic optimum is reached where the benefit of further improved performance is not worth the extra cost.

# BUILDING SYSTEM OPTIONS

## Movable Insulation

Effects of movable insulation upon U-value by hour-weighted consideration:

$$U_w = \frac{U_{w,d} \times t_d + U_{w,n} \times t_n}{24}$$

- $U_w$  = Heat coefficient of window
- $U_{w,d/n}$  = U-value day / night
- $t_d$  = Number of day hours
- $t_n$  = Number of night hours

When combined with a roller blind, a thermopane window improves its insulating value from  $U = 3.1$  to  $U = 2.3$  W/mK. When in place for 10 hours at night, the daily average U-value is around 2.65 W/mK.

From the energy point of view, windows act as solar apertures (heat trap) during daytime when facing the sun. At night or during periods without sunshine, however, they operate as heat wasting elements. In order to improve the thermal performance characteristics of a window, movable insulation systems may be used. Very simple solutions are interior devices like curtains and reflective layers, sliding rolling and folding panels or horizontal louvers. Internal locations may cause problems of condensation at the cold glazing. The best, but also more costly devices, are external elements. Exterior shutters avoid problems with thermal bridges and condensation (see Booklet 5, Construction Issues). The air space between two panes of glass may also be used for movable insulation. Possible devices like louver blinds, low emissivity foils or beadwall® use the cavity, and are protected against mechanical and meteorological damages at the same time. Different details and possibilities of location are given in Booklet 5, Construction Issues.

Since movable insulation devices may cause problems when not properly designed (tightness, operation, material, location related to the glazing), a device which can be either insulation in winter or shade in summer would probably be the most cost effective solution.

Designers should seek a proper balance between south-facing windows with properly situated thermal storage mass on the one hand, and building insulation and moveable insulation to limit heat loss on the other hand. A design decision of comparable importance is the selection of a suitable heating system with a night set-back thermostat; the latter is covered in detail elsewhere (see section 4, Auxiliary Space Conditioning).







								
1 mm	12 mm	6 mm	4 mm	9 mm	12 mm	60 mm	40 mm	20 mm
ALU single	ALU insulated	PVC Insulated	PVC air space	PVC half insulated	PVC air space	Beadwall Ø 6-8	Foam glass	4-layer warmhang
$2.92 \frac{W}{m^2 K}$	$2.65 \frac{W}{m^2 K}$	$2.64 \frac{W}{m^2 K}$	$2.36 \frac{W}{m^2 K}$	$2.28 \frac{W}{m^2 K}$	$2.03 \frac{W}{m^2 K}$	$0.90 \frac{W}{m^2 K}$	$0.70 \frac{W}{m^2 K}$	$0.59 \frac{W}{m^2 K}$
94 %	85 %	85 %	76 %	74 %	65 %	29 %	23 %	19 %
U-values of different nocturnal insulation devices in addition to a double glazing U-value $3.1 \text{ W/m}^2\text{K} \hat{=}$ heat loss 100%								

Figure 3.12



# BUILDING SYSTEM OPTIONS

In passive solar designs, the glazing system plays a decisive role in the heat balance of the building. Sizing, orientation, and thermal properties of the glazing have to be balanced to fulfill the requirements of trouble free operation in winter (maximum of solar gain, minimum of heat losses) and in summer (avoidance of overheating, sufficiency of daylighting).

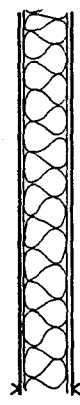
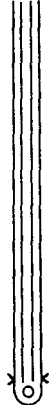
A variety of glazing materials are available which should be carefully considered during the pre-design stage. The major features for evaluating glazing types are given in the table below (figure 3.13). In concert with these properties, attention should be paid to the angle of incidence related to altitude and azimuth of solar radiation. The graph of figure 3.14 shows the rapidly decreasing solar transmittance of standard thermopane glazing deviating more than 55° from perpendicular position to the sun.

For an individual design, the glazing type should be chosen first to determine whether a positive window energy balance is achieved. Then, appropriate glazing material should be optimized according its size, orientation and function. Glass is a very good heat conductor - in comparison to polyurethane foam of equivalent thickness the conductance is about 500 times faster. The development of glazing technologies, however, offers a variety of thermally improved systems: multiple glazed units, gas-filled double-pane systems, low-e coatings, selective transmissivity coatings, Heat Mirror and HIT-glazing (High Insulation Technology) reaching U-values around 0.65 W/m<sup>2</sup>K. Some of these solutions are not yet very common and may therefore be too costly for most residential buildings.

## 3.3 Glazing

GLAZING TYPE	light transmission (%)	colour reproduction index (%)	g-value of glazing (W/m <sup>2</sup> K)	U-value of glazing (W/m <sup>2</sup> K)	U-value of overall window (W/m <sup>2</sup> K)	maximum size, length/width (cm/cm)	spec. gravity (kg/m <sup>3</sup> )
<b>clear glass</b>							
- single	90	99	87	8.5	5.2	-	10
- double	82	99	77	3.0	2.9	240/400	20-30
- triple	74	99	72-73	2.2	2.3	240/400	30-40
<b>antisun glass</b>							
- absorption glass	20-64	90-96	30-49	3.0	2.9	250/500	<35.5
- reflecting glass	40-63	90-96	30-45	1.7-2.2	2.0-2.3	250/360	30
<b>low-e-glazing</b>	65-79	94-96	57-67	1.7-2.2	2.0-2.3	141/240	20
<b>diffusing glass</b>							
- insulation glass	48	98	35	2.6	2.6	141/240	22
- acrylic glass	65	99	40	1.7-2.5	2.0-2.5	115/300	2.0
- plexiglass	81-86	-	80-83	1.9-2.6	2.1-2.6	1200/6000	5-6.5

**Figure 3.13**  
Physical properties of different glazing types.

**Figure 3.14**  
Solar transmittance of different glazing materials versus angle of incidence.

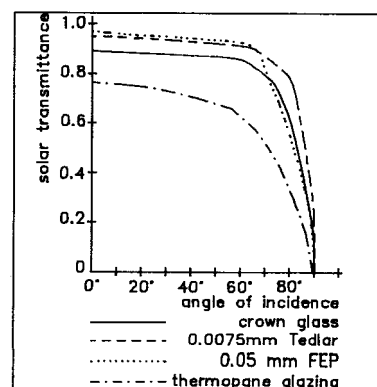

# BUILDING SYSTEM OPTIONS

Apart from the widespread application of sealed double glazing units (insulating glass U-value 3.3 W/mK), other multiple glazings like triple or quadruple glazed windows are rarely installed because of the structural requirements on the frame construction. Instead, low-e glass is becoming very popular for residential applications, a remarkable U-value of 1.7 - 1.3 W/mK without any extra weight. Responsible for its energy efficiency is a thin low emissivity coating on the indoor pane; it reduces the winter heat loss and reflects infrared radiation (wave-length selective) of summer solar heat, while providing transparency to visible light (see figure 3.16). Even so, it has the disadvantage of cutting down the transmission of near-infrared fraction of the solar spectrum and thus lowering the total solar transmittance for passive systems.

Another similar principle is a unit with a low-e plastic film suspended between two panes of glass (Heat Mirror®). The coated film reflects long wave infrared radiation from the inner pane. Because of its two air spaces, this principle is very energy efficient; it is comparable to triple glazing.

The challenge begins for the designer when the different seasonal requirements must be optimized: maximum solar gain in winter and minimum solar gain in summer should harmonize with a reduction of heat losses and pleasant supply of natural light. Together with the proper sizing, orientation and shading of the glazing areas, the physical properties of glazing material play a decisive role.

Figure 3.16 Increase of indoor air temperature versus different glazings depending on window ratio variations.

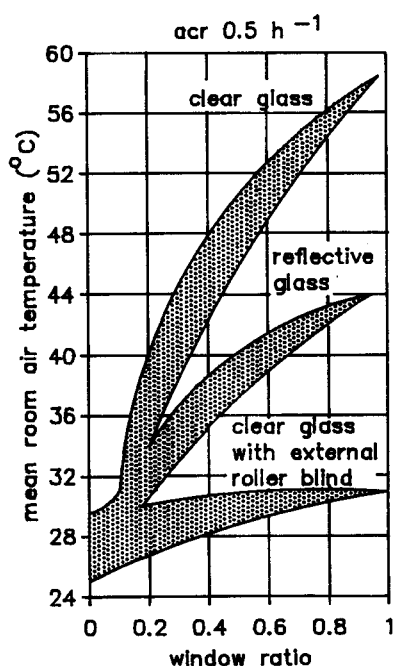
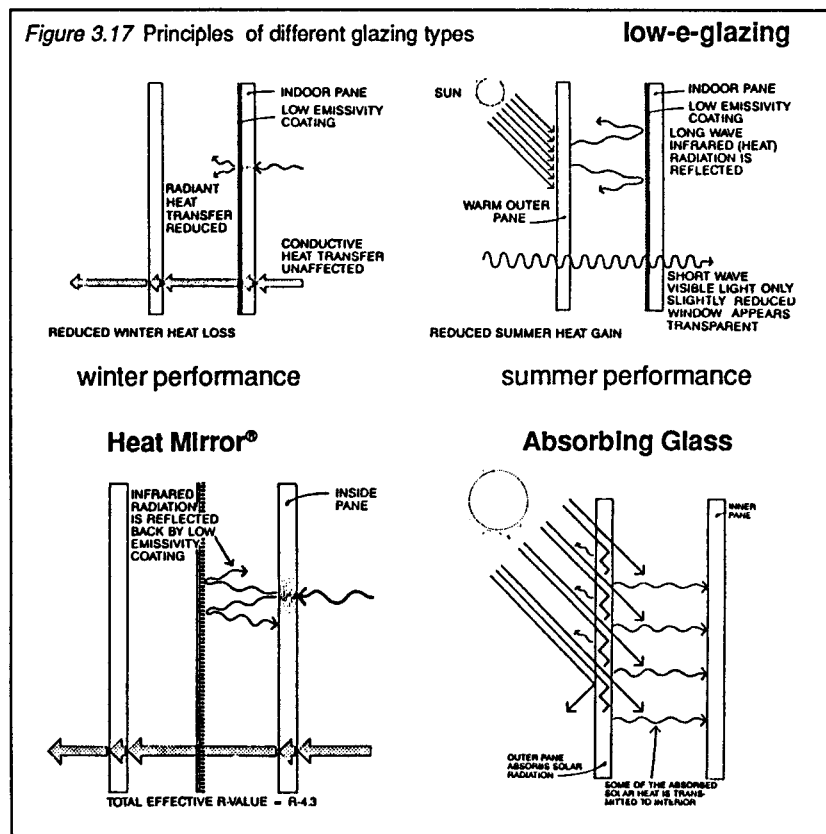

Figure 3.17 Principles of different glazing types



## BUILDING SYSTEM OPTIONS

From the construction point of view, glazing materials have to fulfill a variety of requirements in passive solar design. According to the specific application within a solar system, the following main characteristics should be carefully checked to avoid unpleasant surprises:

- Thermal and optical quality
- Weatherability and UV-resistancy
- Lifespan and cost
- Weight, size limitations, and construction features
- Thermal characteristics of glazing spacers and window frames

	ADVANTAGES	DISADVANTAGES
<b>GLASS</b>	<ul style="list-style-type: none"> <li>• excellent selective transmission</li> <li>• transparency</li> <li>• good weatherability</li> <li>• heat, air-pollution and UV-resistancy</li> <li>• low thermal expansion</li> <li>• easily obtained</li> </ul>	<ul style="list-style-type: none"> <li>• expensive</li> <li>• breaks easily</li> <li>• heavy - weighted</li> <li>• often difficult to install in large sheets</li> </ul>
<b>ACRYLIC</b>	<ul style="list-style-type: none"> <li>• high optical clarity, strength, weatherability</li> <li>• light weight and easy to handle</li> <li>• impact resistancy</li> <li>• insulation and transmission similar to glass</li> </ul>	<ul style="list-style-type: none"> <li>• expensive</li> <li>• prone to surface abrasion</li> <li>• buckles and cracks if not properly installed</li> <li>• significant expansion and contraction characteristics</li> <li>• tendency to sag at high temperatures</li> </ul>
<b>POLYCARBONATE</b>	<ul style="list-style-type: none"> <li>• very high impact resistancy</li> <li>• similar to acrylics, but less solar transmission</li> </ul>	<ul style="list-style-type: none"> <li>• scratches easily</li> <li>• not rigid</li> <li>• becomes brittle and changes color after pro-longed exposure to the sun</li> </ul>
<b>FIBERGLASS</b>	<ul style="list-style-type: none"> <li>• low cost, easy to handle</li> <li>• high strength and durability with coatings such as Tedlar</li> <li>• availability: flat or corrugated</li> </ul>	<ul style="list-style-type: none"> <li>• solar transmittance reduced when UV - coatings are added</li> <li>• will yellow and "blossom" without coatings</li> <li>• medium lifespan</li> </ul>
<b>POLYESTER FILM</b>	<ul style="list-style-type: none"> <li>• low cost</li> <li>• high surface hardness</li> </ul>	<ul style="list-style-type: none"> <li>• UV - degradation if not coated</li> <li>• relatively high longwave transmittancy</li> <li>• medium lifespan</li> </ul>
<b>POLYETHYLENE FILM</b>	<ul style="list-style-type: none"> <li>• very inexpensive</li> <li>• light, flexible, easy to install</li> <li>• good glazing properties for cavity installation</li> </ul>	<ul style="list-style-type: none"> <li>• short lifespan (less than one year)</li> <li>• poor resistancy to long-wave radiation</li> <li>• wind and temperature can cause sag</li> </ul>
<b>POLYVINYL FLUORIDE FILM</b>	<ul style="list-style-type: none"> <li>• excellent weatherability and strength</li> <li>• high solar transmittance</li> <li>• can be bonded to fiberglass for UV - resistancy</li> </ul>	<ul style="list-style-type: none"> <li>• expensive</li> <li>• available only in thin films</li> <li>• relatively high longwave transmittancy</li> </ul>

*Figure 3.18*  
Comparison of different glazing materials (recommendations on construction features are presented in Booklet 5, Construction Issues).

# BUILDING SYSTEM OPTIONS

## Sunspace Glazing

Since a sunspace system is the most complex passive-hybrid solar system, the relations between construction system options and individual user requirements should be discussed during the very early design stage.

The matrix of figure 3.19 shows a variety of determinants for the evaluation of sunspaces: According to national/regional availability of systems and materials, as well as the requirements of space use and orientation, different construction systems are evaluated by features of design, visual appearance, construction detail, thermal quality, and economics. Due to the individual nature of sunspace designs, the various options will vary in importance.

Example:

- Galvanized steel construction, known from commercial greenhouse utilization, is the cheapest solution for small budgets. On the other hand, its poor appearance and thermal quality (single glazing, no thermal breaks) are disadvantages. This may limit the type of space use, depending on local climate conditions.
- If a sunspace should serve as a "green living room" with year round use, a heating system may be required to guarantee plants' survival in case of low temperatures, depending on climate and design. Since heat losses should be minimized, the thermal quality of glazing and construction play a decisive role. The choice of an insulated or timber structure is necessary. Material choices may depend on architectural, visual and aesthetic factors (see Booklet 5, Construction Issues).

Figure 3.19

Determinants for various sunspace constructions: The actual selection of a sunspace construction depends on its thermal quality related to the use of the sunspace.

CONSTRUCTION FEATURES	PLANNING CRITERIA	DESIGN			VISUAL APPEARANCE			CONSTRUCTION			THERMAL QUALITY				ECONOMICS	
		layout variety	sectional variety (sloped roof)	screen variety	location and size of openings	design of construction details (roof connections)	door and window rabbets	operation facilities (mechanism)	load bearing	constructive connections	applications (i.e. built-in units, shading devices)	heat transmission of construction	heat losses of glazing (single = double)	joint tightness of fixed glazing	joint tightness of openings	costs (rough estimation)
galvanized steel construction clip glazing	⊥	○	○	○	+	○	○	○	+	○	○	-	-	-	-	+
galvanized steel construction cement glazing	⊥	○	+	○	+	+	○	○	+	+	○	-	-	+	-	+
galvanized steel construction	⊥	+	+	+	+	+	+	+	+	+	○	+	+	+	○	+
thermal isolated steel construction galvanized or coated	⊥	+	+	+	+	+	+	+	+	+	○	+	+	+	+	⊥
aluminium clip glazing	⊥	⊥	⊥	⊥	○	-	⊥	⊥	-	⊥	⊥	-	-	-	-	+
aluminium cement glazing	⊥	⊥	○	⊥	○	-	⊥	⊥	-	⊥	⊥	-	-	+	-	+
aluminium clip glazing with caulking	⊥	⊥	⊥	○	⊥	○	○	○	-	⊥	⊥	-	+	○	⊥	⊥
aluminium clip glazing, with caulking, thermal isolated	⊥	○	○	⊥	○	⊥	○	○	○	○	○	-	+	+	⊥	⊥
thermal isolated aluminium construction	⊥	+	○	+	+	+	+	+	+	+	+	+	+	+	+	-
thermal isolated clip glazing aluminium	⊥	+	+	+	+	+	+	+	+	+	+	+	+	+	+	-
PVC construction with steel reinforcement	⊥	+	+	+	+	+	+	+	○	+	+	+	+	+	+	○
timber construction	⊥	+	+	+	+	+	+	+	+	+	+	+	+	○	+	○
combination of wood - steel / wood - aluminium	⊥	+	+	+	+	+	+	+	+	+	+	+	+	+	+	⊥

# BUILDING SYSTEM OPTIONS

Solar apertures are designed to optimize solar heat gain during the heating season. Thus, solar control mechanisms must be employed to block solar irradiation when overheating and/or glare problems arise during the summer. Depending on diurnal and seasonal incident radiation angles, different shading strategies and determinants should be considered.

External devices, which block sunlight before it passes through the glazing, are the most effective solar control strategy to avoid overheating. This can be achieved by trees, preferably deciduous trees (natural shading), horizontal and/or vertical overhangs or other parts of a building (architectural shading), or by fixed and/or movable shading devices.

Horizontal overhangs and fins are adequate devices for south-facing glazing. In a proper design, it should be possible to solve winter overheating by simply opening a window. East and west-facing windows should be supplied by vertical adjustable louvers, fins or awnings.

The efficiency of the shading effect is characterized by the shading coefficient of the glazing system given in figure 3.20. A value of 1.0 gives maximum solar gain through the glazing to the interior; a value of 0.0 indicates no solar gain to the interior. The shading coefficient may be scheduled to model movable insulation or solar exclusion devices, i.e., white curtains closed during summer.

## 3.4 Shading

### External Devices

**Figure 3.20**  
Shading coefficients of selected glazings and shading devices.

Shading Devices	Shading Coefficient
<b>Glass (with no shading indoors or outdoor)</b>	
6 mm clear plate-glass	0.95
10 mm clear plate-glass	0.90
5 mm heat absorbing glass (gray, bronze, or green tinted)	0.75
12 mm heat absorbing glass	0.50
Dark gray metallized reflective coating on glass	0.35 - 0.20
Light gray metallized reflective coating on glass	0.60 - 0.35
<b>External Elements</b>	
Egg-crate	0.10
Panels or awnings (light color)	0.15
Horizontal louver overhang	0.20
Horizontal louver screen	0.60 - 0.10
Continuous overhang or cantilever	0.25
Vertical louvers or fins (fixed)	0.30
Vertical louvers or fins (moveable)	0.15-0.10
<b>Interior</b>	
Aluminum venetian blinds (with slates adjusted to prevent transmission of direct sun rays)	0.45
Light colored venetian blinds	0.55
Off-white curtain 200-270 g/m <sup>2</sup>	0.40
Dark gray curtain 200-270 g/m <sup>2</sup>	0.60
Open-weave fabric curtain	0.75 - 0.60

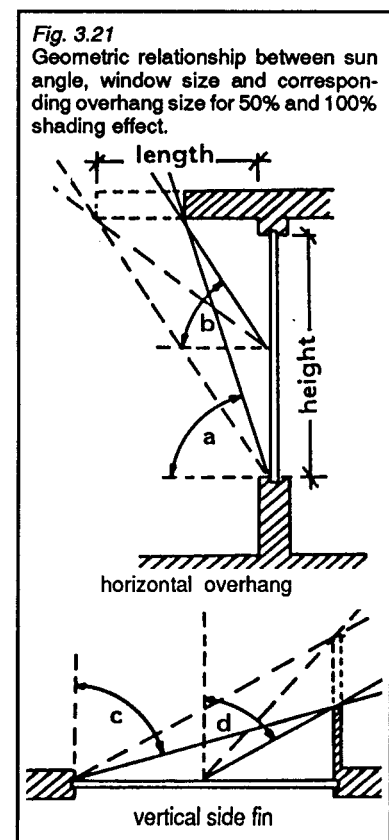

# BUILDING SYSTEM OPTIONS

## Internal Devices

Internal devices like curtains, roller shades, panels, and venetian blinds are less effective for overheating avoidance since radiation are not blocked or reduced until after having passed through the glazing element. At that point, some of the solar radiation will turn into heat, and the heat will be mixed with the indoor air.

Nevertheless, they serve for glare protection and they are easy to operate and to maintain. Depending on the system, horizontal louvers can provide daylighting by reflecting sunlight deeply into the space by dynamic response to the sun's movement. The same effect can be achieved by selective transmissivity films reflecting the sunlight back to the outside but providing up to 75% transmitted visible light.

Whether using opaque or translucent shades, or clear or coated films, if the shading device is adjustable and/or reversible with a bright and a dark coloured side, it could be used for shading in summer and heat absorbing in winter. Multiple layers of draperies containing an air space in between additionally improve the thermal quality of the window during winter nights. The effectiveness of different devices is evaluated by figure 3.22; construction principles are presented in Booklet 5, Construction Issues.

The most energy efficient way of controlling the energy flow from outside to inside and vice versa is realized by a combination of shading devices and movable insulation (see page 56).

Figure 3.22  
Evaluation matrix for shading devices

SHADING DEVICES good    poor												
	REGULAR GLASS	MEDIUM DARK TINTED	INSIDE BLIND	CURTAIN	OVERHANG	TREE	INTERNAL BLIND	SHADING SCREEN	OUTSIDE BLIND	SWISS BLIND	INSULATING SHUTTERS	
EASE OF MAINTENANCE	●	●	◐	◑	◒	◓	◔	◕	◖	◗	◘	◙
SHADING COEFFICIENT	○	◐	◑	◒	◓	◔	◕	◖	◗	◘	◙	◚
INSTALLATION COST	●	●	◐	◑	◒	◓	◔	◕	◖	◗	◘	◙
MATERIAL COST	●	◐	◑	◒	◓	◔	◕	◖	◗	◘	◙	◚
EASE OF INSTALLATION	●	◐	◑	◒	◓	◔	◕	◖	◗	◘	◙	◚
AVAILABILITY	●	●	●	●	●	◐	◑	◒	◓	◔	◕	◖

# BUILDING SYSTEM OPTIONS

One should distinguish between passive and active solar energy use. Active solar systems require a solar collector outside the living space to collect and absorb solar energy and to convert it into heat, transferring it to a separate storage element by a pump or fan. This interaction defines both useful energy gains and the level for indoor space conditions. Hybrid systems typically have an active component, i.e., a fan for charging a passively discharging storage element. Most air systems are hybrid systems, as natural convective loops would not operate efficiently.

The illustrations in figure 3.23 demonstrate a broad range of solar collection/storage and distribution elements in passive-hybrid buildings.

The next section describes the basic features and seasonal requirements of passive-hybrid solar heating systems.

## 3.5 Passive / Hybrid Solar Heating Systems

**Figure 3.23**  
Survey of various passive and hybrid solar systems with different locations of the heat storage unit.

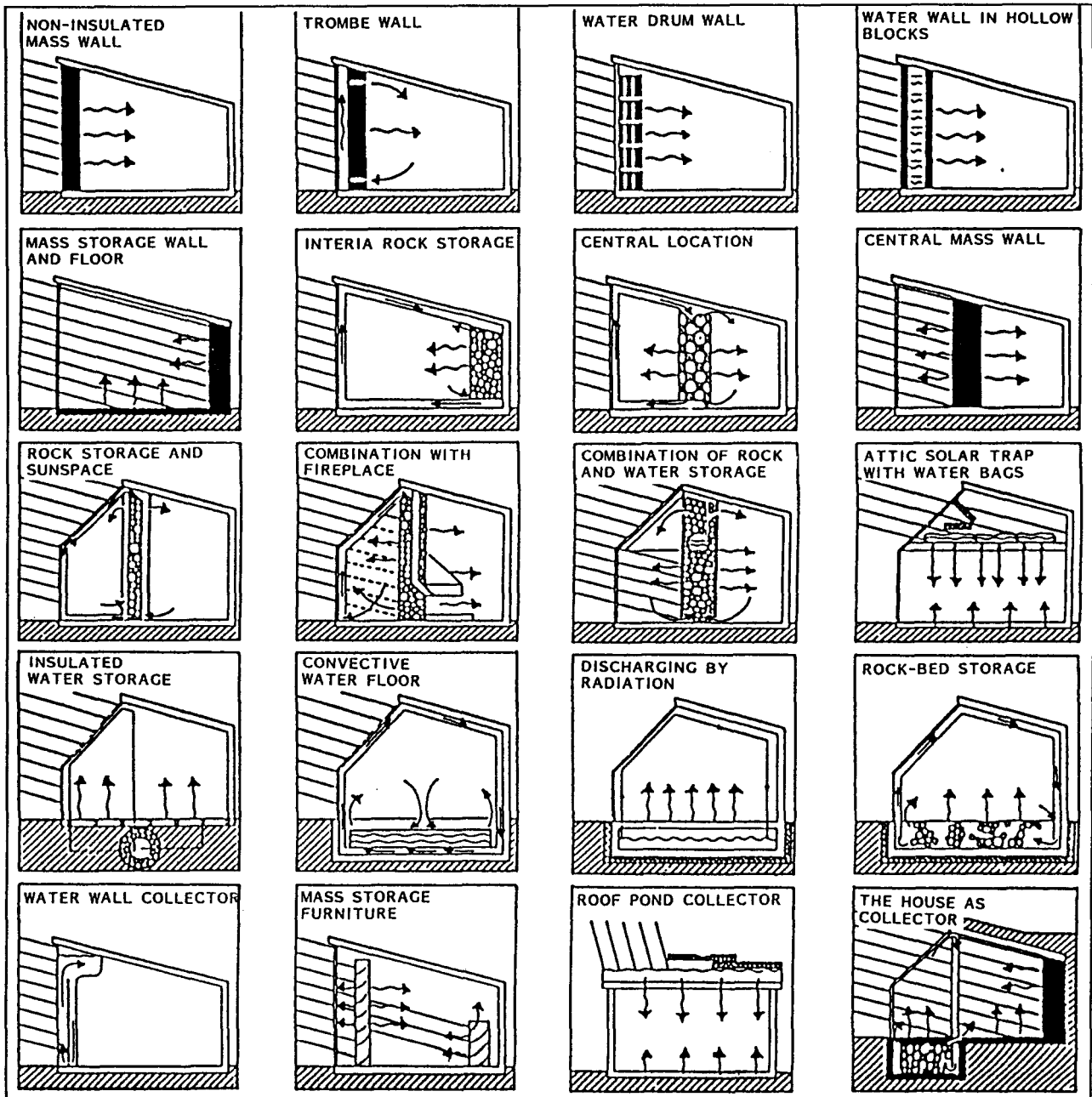

# BUILDING SYSTEM OPTIONS

## DIRECT GAIN

### Winter Day

- maximum penetration of solar radiation into the building
- reflector or corresponding options of exterior ground material could increase insolation (pay attention to glare effects)

### Winter Night

- minimize heat losses by movable insulation/shading devices: (roller) blinds, shutters, beadwall<sup>®</sup>, folders, hinged reflectors or low emissivity coatings on glass.
- release of low temperature heat from mass storage building components (walls, floor)

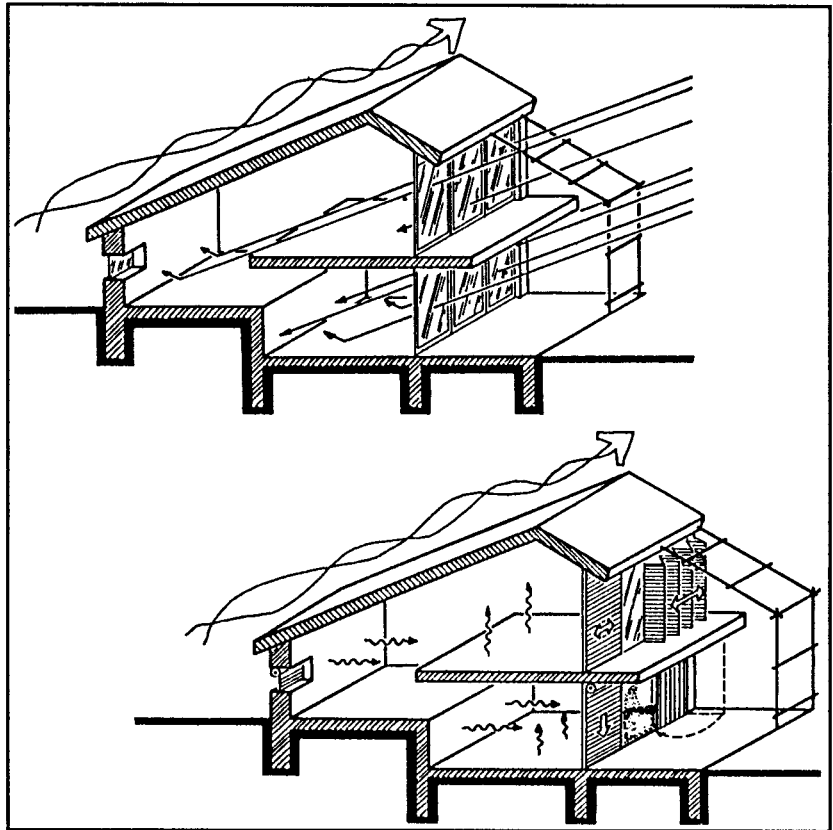

Figure 3.24

### Summer Day

- sun protection by overhang, awning, trellises (deciduous plants), trees, blinds, shutters, beadwall<sup>®</sup>, and so on
- cross ventilation through the building (depending on ambient temperature)

### Summer Night

- cross ventilation through the building (natural cooling) when outdoor temperature drops down to 20 °C or below

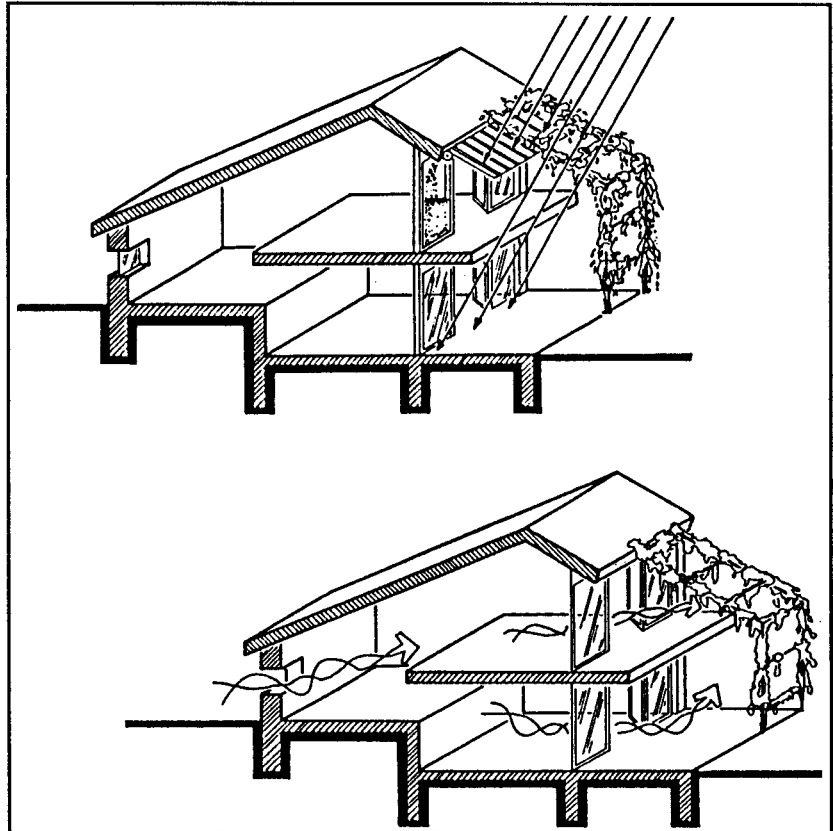

Figure 3.25



# BUILDING SYSTEM OPTIONS

---

From the technical point of view, the direct gain passive heating system is the simplest one: all south-facing windows act as solar collectors. Low-angle winter solar short-wave radiation penetrates deeply into the building, and is absorbed by mass floor and interior walls. Converted into long wave heat, some energy is stored for release as the room cools down at night. Generally, the system operates without any mechanical equipment for energy collection, storage, and distribution. The system is self-acting according to thermodynamic principles of heat transfer (see Booklet 1, Energy Design Principles in Buildings). Nevertheless, certain considerations of essential importance should be noted.

## DIRECT GAIN

The total amount of south-facing glass should relate to the local incident radiation conditions and daily ambient temperature gradient during the heating season. During overcast periods, too large a window area would lose more energy than it could ever gain under clear sky conditions. (see Booklet 3, Design Guidelines).

### Glazing

Incident solar radiation should be absorbed by mass storage material in the floor and walls to be reradiated and reconverted to the room with a certain time-lag (see page 52 and Booklet 1, Energy Design Principles in Buildings). Carpets should not cover the thermal mass in the floor. Storage is most effective when directly irradiated by the sun.

### Storage

Since the direct gain system directly interacts with interior building components, the heating system must allow an adequate response to solar gains to make them useful. A quick heating system (i.e., convectors) with room-by-room thermostatic control can be very beneficial. Floor heating and other slow-delivery systems can cause winter overheating problems by continuing to deliver heat after rooms have already been heated to 20 °C by the sun (see section 4).

### Auxiliary Heating

Movable insulation devices increase the energy efficiency of direct solar systems during long winter nights. There is a great variety of different products (see Booklet 5, Construction Issues) with different functions, appearance, and costs.

### Movable Insulation

In summer, overheating must be controlled by window shading devices:

- Architectural measures can be achieved by building features such as cantilevers, overhangs, canopies and balconies with or without external bracing; these must be designed according to solar-geometrical considerations.
- Natural shading may be provided by existing (deciduous) trees, or planned trellises and structures for vegetation; should be chosen after careful consideration of orientation, growing density, growth speed and soil conditions.
- Flexible shading for daily or seasonal operation is commercially available for exterior, interspace, and interior attachment. From the economic thermal performance, exterior shading devices are most effective as combined systems because they can double as thermal insulation in winter (see Booklet 5, Construction Issues).

### Solar Control

Cross ventilation is required to mitigate short-time overheating (see Booklet 1, Energy Design Principles in **Buildings**).

### Ventilation

## THERMAL STORAGE WALL

### Winter Day

- daylighting through adjacent windows
- warm air delivered through vents in wall
- vented construction can be supported by a fan (hybrid operation)
- optional reflectors to increase incident radiation
- unvented construction can be used as well, heat transfer through the wall by conduction

### Winter Night

- storage wall releases heat to adjacent rooms
- reradiation by floor/ceiling (hybrid operation only)
- movable insulation by shutters acting as reflectors at daytime, blinds, beadwall®, and so on

### Summer Day

- cross ventilation through the building depending on outdoor temperatures
- shading by blinds, shutters awnings, overhangs, and so on

### Summer Night

- cross ventilation through the building when outdoor temperature drops down to 20 °C or below
- venting the airspace between the glass and wall will improve daytime cooling

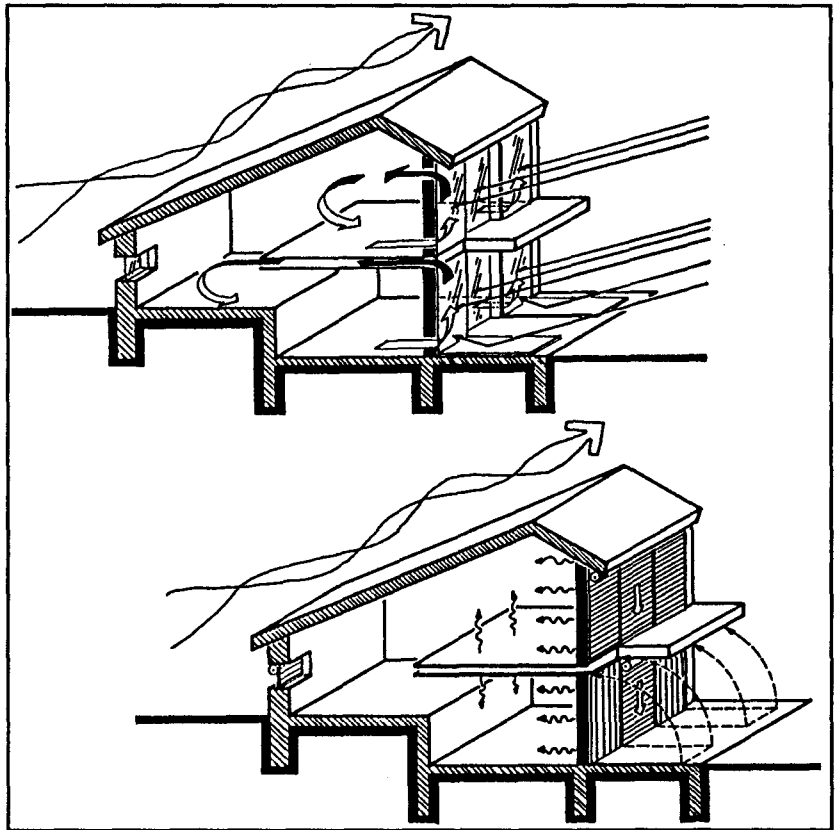

Figure 3.26

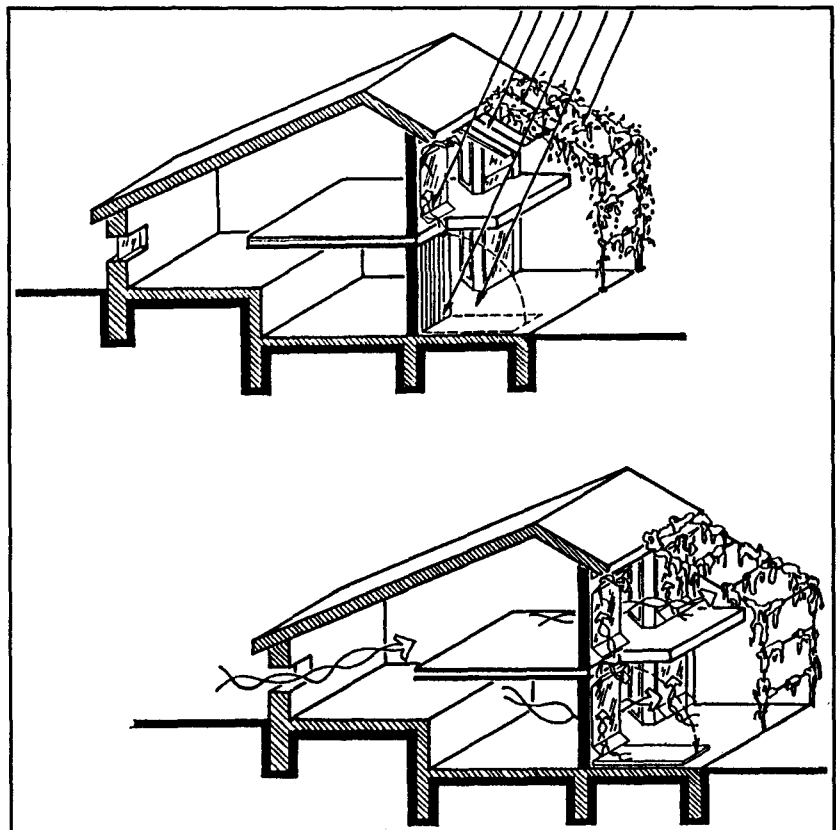

Figure 3.27

# BUILDING SYSTEM OPTIONS

---

The basic thermal storage wall consists of a mass wall of concrete or water covered with a selective absorbing surface and single glazing. Absorbed solar radiation is stored and will be emitted to the room **by a** time lag that varies with wall thickness and conductivity (see page 52 and Booklet 1, Energy Design Principles in Buildings).

Classical Trombe Walls use vents for air circulation between the cavity and the adjacent room. However, an unvented thermal storage wall combined with direct gain windows is the preferred system. (Venting requires that the back side of the glazing will be accessible for periodic cleaning).

## THERMAL STORAGE WALL.

### Recommendations for pre-design:

- Orientation of storage wall should be south. Depending on intention of space use and architectural design of facade, design integration of opaque wall and window areas (for views and ventilation) is necessary.
- Storage material must have high heat storage capacity and conductivity (see Booklet 1, Energy Design Principles in Buildings and Booklet 5, Construction Issues).
- To maintain an optimum time lag, dimension of wall thickness depends on expected incident radiation and ambient temperature level and swing during the heating season (see section 3.1 on page 51, 52, and Booklet 3, Design Guidelines).
- Glazing of storage wall could be realized by different materials (see Booklet 5, Construction Issues) in which thermal quality directly determines systems efficiency. Application of translucent insulation extends the utilization for temperate and even cold climates. Attention has to be paid to shading in summer to avoid overheating.
- Avoidance of overheating in summer is possible by shading devices similar to those of direct gain systems (see page 64 and Booklet 5). Depending on latitude and solar altitude, shading devices are not needed when the system is designed to be ventilated to the outside using the solar chimney effect (see Booklet 5, Construction Issues).
- Sufficient system performance can only be expected when climatic conditions guarantee high solar incident radiation and sunshine hours during the heating period and/or using movable insulation. Use of a selective surface coating is a low-maintenance alternative to the use of moveable insulation.
- Thermal storage walls may also be modified as a hybrid system in a semiclosed or entirely closed cycle: supported by a fan, heated air will be blown into hollow wall and/or ceiling elements in order to achieve a radiant heating effect by exposed surfaces within a room.
- Unvented configuration is preferred because of excellent performance and reduction of maintenance problems, dirt, and so on. However, the system should be used in combination with direct gain windows.

### Orientation

### Storage

### Glazing

### Solar Control

### Movable Insulation

### Hybrid System

# BUILDING SYSTEM OPTIONS

## AIR COLLECTOR

### Winter Day

- convective loop by opening interior vents of collector
- vented construction (ceiling, wall and floor) as a closed hybrid system supported by a fan
- exterior ground surface may increase insolation by reflection

### Winter Night

- low temperature heat release by storage mass within room
- moveable insulation is not required for collector areas

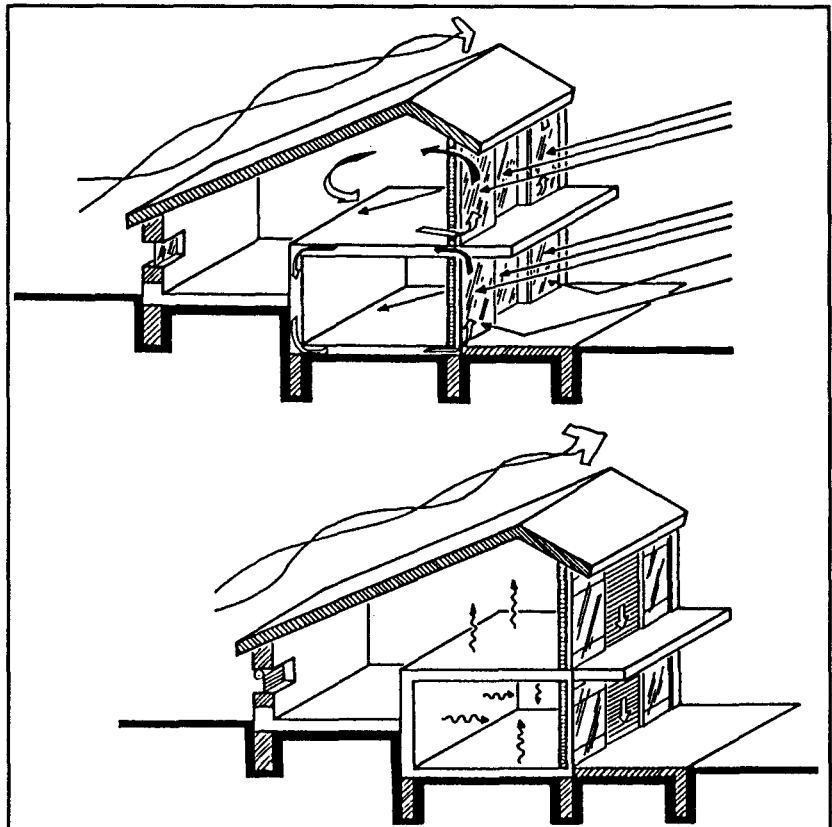

Figure 3.28

### Summer Day

- cross ventilation through the building
- ventilation through hollow ceiling construction, generated by solar chimney effect
- shading of collector area by overhang or movable devices
- vent collectors to the outdoors

### Summer Night

- cross ventilation through the building when outdoor temperatures drop down to 20 °C or below
- ventilation (cooling) through hollow ceiling construction (supported by a fan)

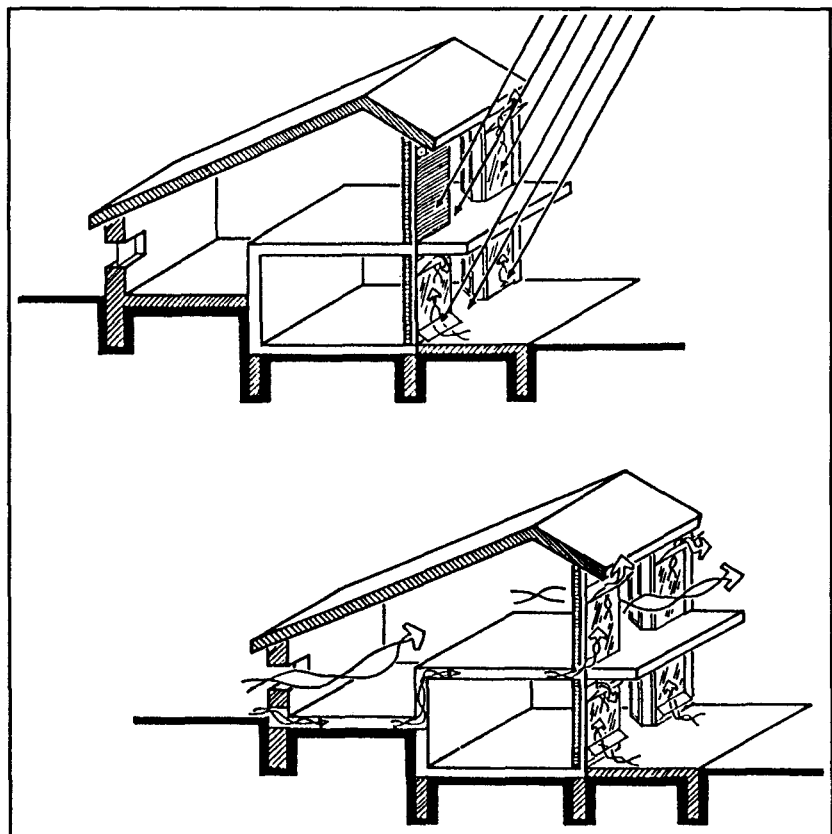

Figure 3.29

# BUILDING SYSTEM OPTIONS

---

In principle, the performance of an air collector passive system as an integrated element of the facade is a modified thermal storage wall system. The essential difference is that the mass component is replaced by a light and insulated absorber sheet which allows higher collector temperatures. The system could act as an open convective loop (see thermal storage wall) or preferably as a hybrid system using ventilated building elements (hollow concrete ceiling, wall, floor, and rock bed). In this case the use of a fan is necessary; the system must be tight to avoid air leakage.

## AIR COLLECTOR

### Heating strategies:

- Open system related to adjacent room:

Principally comparable with thermal storage wall; however, there is faster heat delivery to the room since incident solar radiation will be absorbed, converted to heat and quickly released as warm air.

### Open System

- Semi-closed heating cycle by air ducts or vented components:

Heated air will be blown into hollow mass ceiling and/or wall construction of the parent space to increase the surface temperature of its building components. Heat will be given off by a time lag to the adjacent rooms by radiation. Supported by a fan, warm air can be directed into northern rooms by insulated ducts and removed through adjacent rooms or ducts as well as into the collector. Sound insulation is required when using open systems (acoustic bridges). An advantageous system operation is a basic heat load supply supported by a back-up heating system for peak load supply.

### Semi-Closed Cycle

- Closed system:

Alternatively, the heated air from the collector can also supply a heat exchanger and/or heat pump depending on auxiliary heating strategy or domestic hot water generation, respectively. Heated air moves in a ducting system, and is not connected with room air. Removal air ducts are directly joined with collector air inlet. Advantages of the system include a completely low temperature, release of heat, and the avoidance of acoustic bridges. The auxiliary heating system could be directly combined with the collector heating cycle (envelope) and controlled by a thermostat.

### Closed System

- Window collector:

The window collector is a variation of the wall collector and contains a movable louver blind acting as an absorber between two glass panes. During high solar incident radiation the heated air of the cavity will be blown into storage mass by a fan. In cases of low irradiation, the louver will be removed to provide direct solar gain through the window.

For summer shading the louvers can be turned, exposing their bright reflective surface to the outside. To improve the U-value of the window, low emissivity glazing is recommended.

# BUILDING SYSTEM OPTIONS

## SUNSPACE

### Winter Day

- convective heating loop by gaps in the common wall
- two-story operation of sunspace may distribute the heat through the building
- fan and duct can be used to move heat to an isolated, north-side room

### Winter Night

- thermal insulation optional at the outside of common wall or interior devices at the glazing of the sunspace: (roller) blinds, shutters, beadwall, reflective foil (heat shield), and so on
- all means directly depend on sunspace use. When used as a greenhouse or living space, a heating system may be required to maintain 5-7 °C

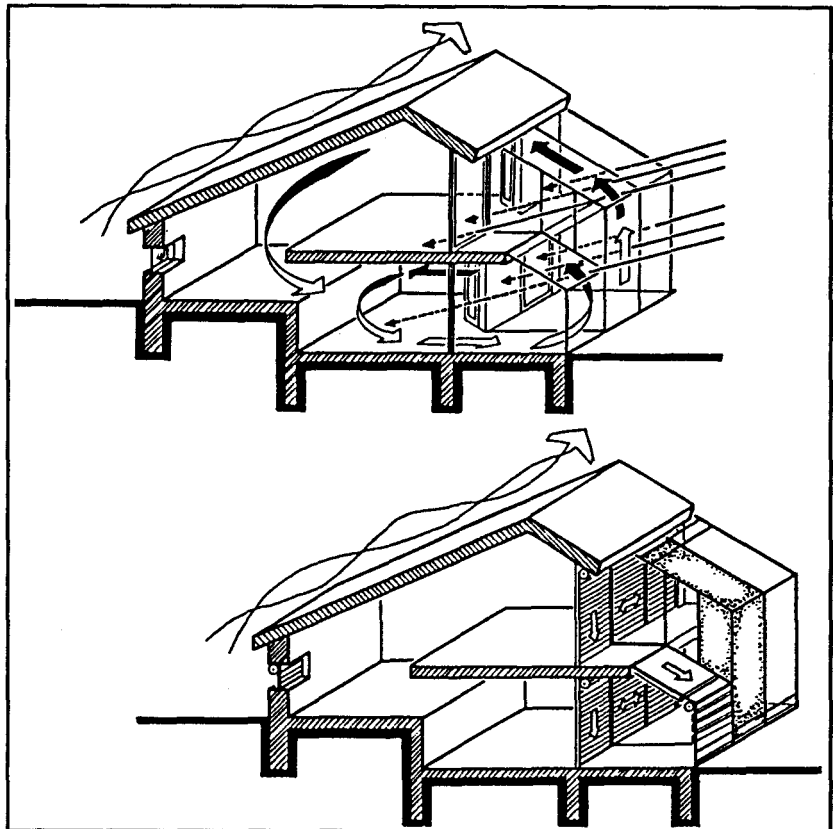

Figure 3.30

### Summer Day

- cross ventilation through building and sunspace
- bottom and top vents
- exterior shading is the best for small sunspaces
- interior shading is the best for larger sunspaces
- consideration of vent location, dimension and construction
- sunspaces with vertical glazing will require much less venting

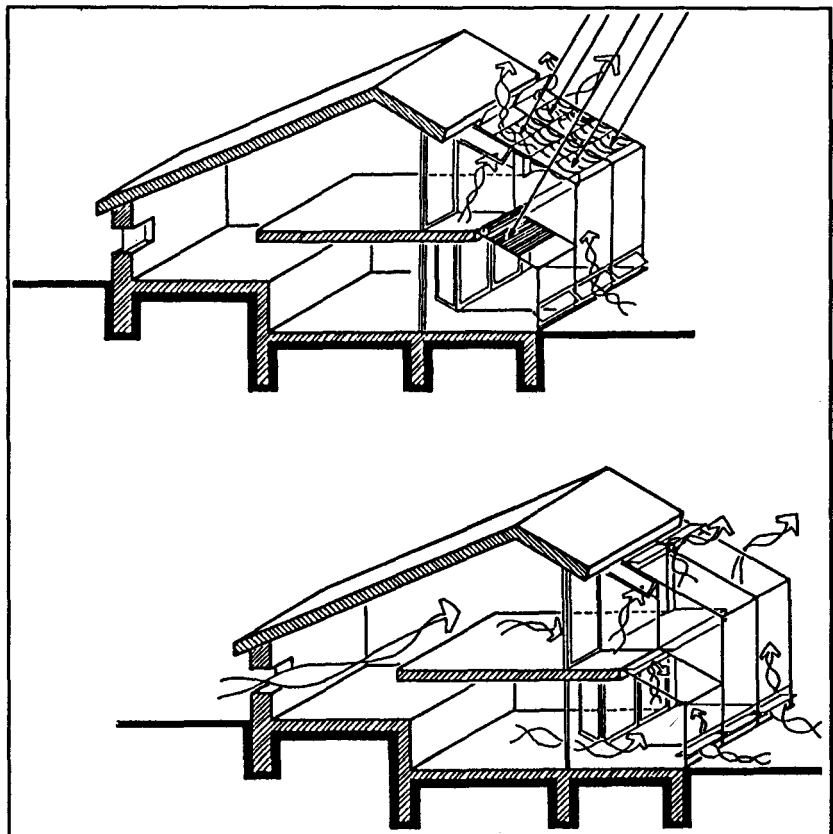

Figure 3.31

### Summer Night

- cross ventilation through the building
- cross ventilation through the sunspace (depending on outdoor night air temperature level)

# BUILDING SYSTEM OPTIONS

---

Sunspaces are often attractive but also are very complex passive solar heating systems. By nature, the sunspace is an accessible collector and offers additional floor area as an extension of the living spaces.

Its design is heavily influenced by ambient climatic conditions (temperature gradients and solar radiation), corresponding to the requirements of all other passive systems. On the other hand, detailed construction, technical and dimensional features are defined by intended use of the space.

Use of sunspace is the dominant design consideration. Size, height, orientation, heating/cooling strategy, thermal quality, interior equipment, choice of material and glazing, solar and thermal control devices, and ventilation needs must all be considered.

The following main aspects should be taken into account to solve this complex optimization problem at the very beginning of the design process:

Basically each sunspace reduces the heating demand of the house by its buffer space effect (see page 47), independent of its orientation. When facing to the sun, a glasshouse becomes a sunspace which improves the heat balance by extra solar gains. Unlike other solar systems, a sunspace with lots of sloped glazing does not require exclusively direct solar radiation but also uses diffuse sunlight (see Booklet 1, Energy Design Principles in Buildings, Greenhouse Effect). Kind and duration (daily and seasonal) of sunspace use are determined by indoor-outdoor climatic relations and occupants' lifestyle.

For this reason, there are two principal approaches to sunspace design. First, the sunspace is never controlled; its use is defined by thermal comfort conditions generated by the ambient climate. The space creates a space extension for intermittent use by occupants in the event of high temperature swings. Thermal quality of construction may play a less important role; simple and inexpensive solutions for shading and ventilation may be sufficient.

Secondly, sunspace is expected to serve as a "green living room" for most of the year. In this case, several important design requirements will change: thermal quality of glazing and construction has to be improved; the relation of glazing and wall area should be optimized according to requirements of lighting for vegetation; and solar protection is necessary against leaf burning of plants and to avoid glare. Depending on the climate, a small heating system may be required to maintain a minimum temperature of 7 °C for subtropical plants.

From the energy point of view, glazing area should be optimized to avoid unnecessary heat losses and overheating problems in summer. Considering geometric principles of seasonal incident radiation, a large amount of vertical glazing is better for heat gain of low-angle winter sun and for reflection of high-angle summer radiation than sloped glazings.

Different sunspace systems are commercially available. Generally, construction options should follow thermal requirements due to the individual climate and space use and to avoid building damage, i.e., by condensation and leaky glazing.

For detailed construction information, see Booklet 5, Construction Issues.

## SUNSPACE

Space Use

Buffer Space

Thermal Requirements

Glazing

# BUILDING SYSTEM OPTIONS

## Sunspace Design Consideration: An Example

In order to evaluate the system performance of a sunspace, the following section will give representative information of temperature development and variations of system components related to temperate climate conditions. The presented data have been established during a four-year research program at Technical University of Berlin, F.R.G. One main objective of the project focussed on investigations for shading and ventilation efficiency in summer to avoid overheating.

### Architectural Restrictions:

A south-facing sunspace had been attached to an existing building, simulating a typical retrofit situation characterized by a slope-roofed detached home. For architectural and constructional reasons the single-story sunspace had to be fitted beneath the eaves of the residence. Unlike recommendations to avoid sloped glazing, the project represents a worst-case study for summer temperature development to be analyzed.

### Constructional Features:

The glazing construction consists of an insulated aluminum framework containing insulated double glazing. Ventilation is provided by automatically operating vents at the bottom and on top of the sunspace. The concrete floor serves as a permanent storage mass covering a second ventilated tubular concrete storage located beneath an insulation layer of 8 cm. Automatically operating interior and exterior shading devices are installed at the slope glazing and at the vertical south-facing areas (see figures 3.34 and 3.35).

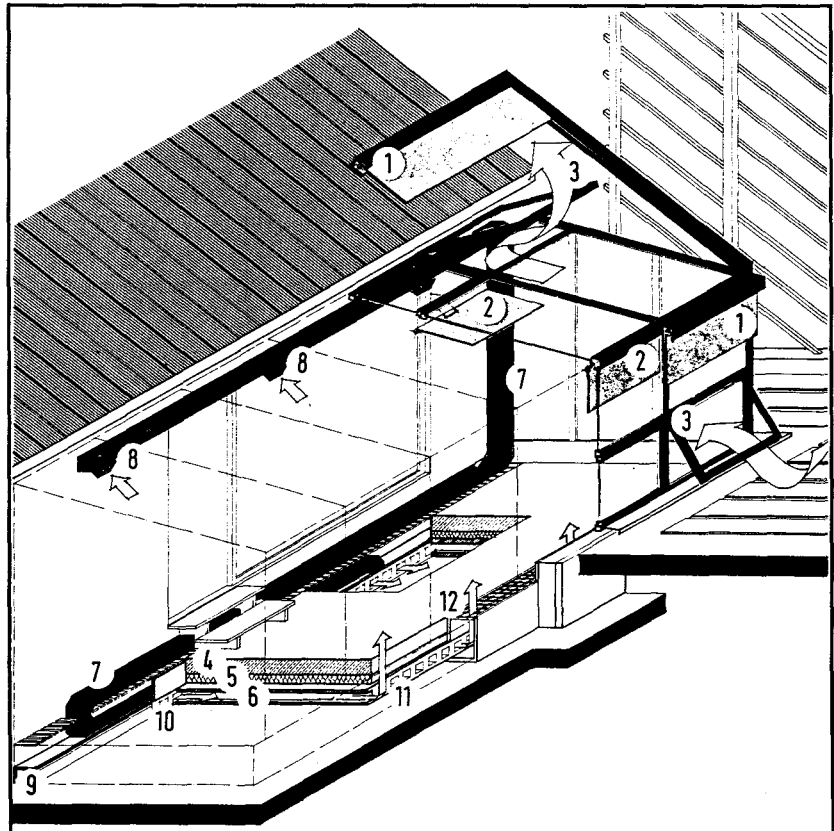

Figure 3.32  
Isometric section of sunspace system  
and building components:

- 1 exterior shading
- 2 interior shading
- 3 vents
- 4 concrete storage mass
- 5 insulation
- 6 ventilated storage
- 7 air duct
- 8 intake air vents
- 9 air distribution
- 10 air inlet
- 11 air outlet
- 12 grid panel



# BUILDING SYSTEM OPTIONS

## Monitoring Results Related to Summer Conditions:

During two heating and cooling periods, various system configurations have been tested. Sunspace temperature is controlled by natural ventilation, interior and exterior shading devices, as well as by combinations.

- Without shading and ventilation the temperature of the sunspace rose to 52 °C (global radiation of 500 W/m<sup>2</sup>, outdoor temperature 25 °C).
- Opening the boom and top vents caused a temperature decrease to 38 °C (800 W/m<sup>2</sup> and 25 °C outdoor temp.). In cases of extreme solar radiation, the ventilation is not sufficient to provide thermal comfort.
- For average summer conditions and during transition periods (300-400 W/m<sup>2</sup>, 12-18 °C) the sunspace temperature averaged 25-28 °C.
- A combination of ventilation and exterior shading effected a temperature difference of 4 °K related to outdoor conditions (see figure 3.33).
- A combination of ventilation and interior shading resulted in comparable indoor temperature due to convecting air between shading and glazing (solar chimney effect, see figure 3.35).

## Conclusion:

For temperate climate conditions, sunspaces can dispense with expensive exterior shading devices in favor of interior shading when sufficient ventilation is provided. Multi-story sunspaces additionally improve indoor temperature conditions because of the increased volume. Less sloped glazing and a more insulated roof would improve the overall energy performance. However, this benefit is somewhat offset by a reduction of natural light transfer to the adjacent space.

Figure 3.33

Temperature performances of the sunspace relating to different shading modes. The upper graph represents the interior temperature ( $T_i$ ) for exterior shading and ventilation. For comparable global radiation conditions ( $G_R$ ) the lower graph shows corresponding temperature performance for indoor ( $T_i$ ) and outdoor ( $T_e$ ) temperatures for interior shading mode.

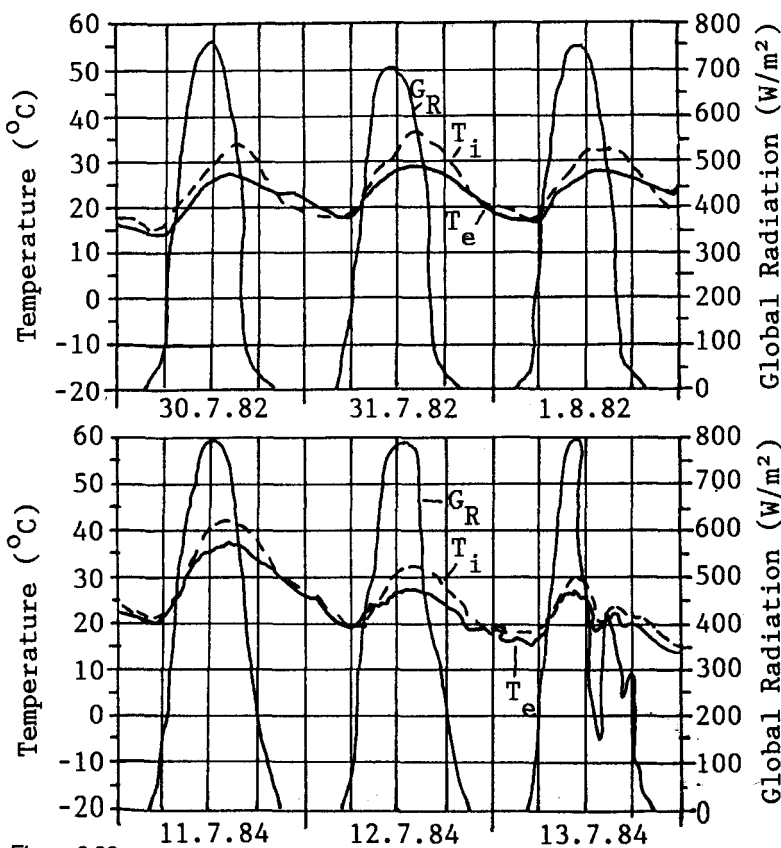

Figure 3.33

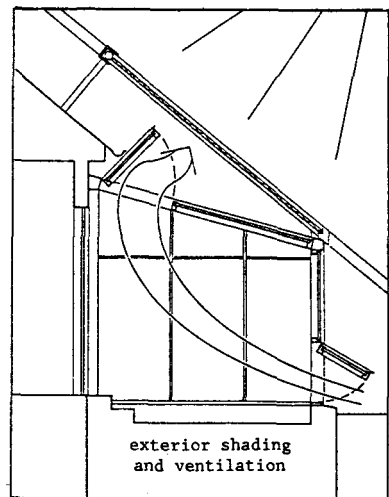

Figure 3.34

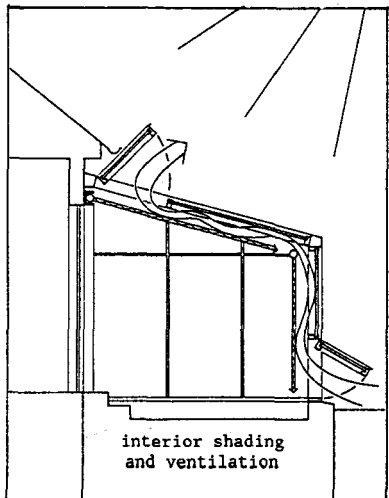

Figure 3.35

# BUILDING SYSTEM OPTIONS

CLIMATIC REQUIREMENTS UPON BUILDING	PASSIVE SOLAR HEATING SYSTEM	DIREC T GAIN	STORAGE WALL
<b>SUITABILITY</b> CLIMATIC REQUIREMENTS UPON BUILDING			
<b>COLD</b> 1. insulation 2. spacial zoning 3. facing sun 4. 5. 6. wind protection 7. 8. 9. 10.	consider: <b>++</b>	-avoid heat losses from large glazing areas, by use of movable insulation or high performance glazings -high thermal quality of glazing area	remarks: <b>-</b> -intensity of solar radiation is not sufficient to improve energy balance of the building -building mass not desired
<b>TEMPERATE</b> 1. insulation 2. spacial zoning 3. facing sun 4. sun protection 5. storage 6. wind protection 7. rain protection 8. natural ventilation 9. evaporation 10.	consider: <b>++</b>	-use of storage mass depends on heating system operation -avoid overheating of space in summer -high thermal quality of glazing areas	consider: <b>(++) O</b> -effective movable insulation and good thermal quality of glazing areas is necessary if duration and intensity of solar radiation is very low -translucent insulation material would improve winter system efficiency (++) , provide sufficient shading in summer
<b>HOT-DRY</b> 1. 2. spacial zoning 3. 4. sun protection 5. storage 6. 7. 8. natural ventilation 9. evaporation 10.	consider: <b>+O</b>	-high storage capacity is necessary for absorption/release of heat by time lag -avoid overheating and glare -provide effective ventilation	consider: <b>++</b> -proper dimension of wall thickness is necessary to ensure heat release by adequate time lag -effective shading and/or ventilation in summer to avoid overheating
<b>HOT-HUMID</b> 1. 2. spacial zoning 3. 4. sun protection 5. 6. 7. rain protection 8. natural ventilation 9. 10. dehumidification	remarks: <b>--</b>	-minimize building openings according to daylighting requirements -effective exterior shading devices	consider: <b>--</b> -storage mass not desired and not effective due to the lack of daily and seasonal temperature swings -additional heat accumulation generally must be avoided

# BUILDING SYSTEM OPTIONS

AIR COLLECTOR	SUNSPACE
consider: <span style="float: right;">○</span> -direct ventilation into the space is not efficient -separate storage is not economical	consider: <span style="float: right;">+</span> -limited space use in case of extremely low ambient temperatures -limited utilization and high temperature swings
consider: <span style="float: right;">+</span> -heat storage possible, e.g., by ventilated hollow mass walls and ceilings -control of air flow is necessary to avoid reversing the airflow at night; use automatic passive dampers teh inversion of system operation -cooling operation depends on ambient temperature conditions	consider: <span style="float: right;">++</span> -a careful design of the sunspace is necessary depending on user intention (buffer space, sunspace, wintergarden, greenhouse, living room) -heating strategy and avoidance of overheating are essentially dependent on space use -energy benefit by buffer space effect regardless of orientation
consider: <span style="float: right;">++</span> -a properly designed mass storage can be charged efficiently by high solar incident radiation -nocturnal inversion of system performance should be avoided by valves	consider: <span style="float: right;">○</span> -effective shading and cross ventilation are absolutely necessary -limited "sensible space use, e.g., by intensive planting -extremely high temperature swings have to be expected -careful detailing and utilization of material
remarks: <span style="float: right;">--(+)</span> -the collector principle can be used as a motive power component (solar chimney) within a passive solar cooling system -air conditioning (cooling and dehumidification) is necessary since conventional passive cooling systems are ineffective	remarks: <span style="float: right;">--</span> -unsuitable from the energy point of view

*Figure 3.37*

Evaluation matrix for passive solar systems versus climate conditions and related building requirements.

Scale of evaluation:

- ++ excellent
- + good
- suitable

## 3.6 Passive Cooling

Cooling problems occur when indoor thermal conditions cause discomfort by overheating. Cooling loads depend on climate (temperature, humidity), building type (structure, shape, compactness) and utilization (kind of use, occupancy, internal loads). Normally, these loads are satisfied by mechanical air conditioning systems. Cost for mechanical cooling can be many times higher than the corresponding expense for heating. Moreover the creation of an artificial indoor climate leads to a climatic monotony and shock effects for people by sudden alterations between natural (outside) and artificial (inside) conditions.

In extreme hot-humid climates, air conditioning systems can hardly be abandoned or replaced. Despite this fact, passive and natural strategies should be developed for residential building design to provide thermal comfort in summertime when ambient conditions permit.

The design of passive cooling strategies has to consider the same physical principles which have to be considered for heating strategies. However, the design has to be done more carefully when buildings require both heating and cooling. The advantages of one strategy may turn to disadvantages for the other, and vice versa.

The principles of cooling systems are described in Booklet 1, Energy Design Principles in Buildings, section 5.8. The following section is a brief overview of passive and natural cooling strategies and dependencies.

## Solar Control

The most essential method of avoiding thermal discomfort during the cooling season is to block the sun from the building envelope and fenestration.

### Pre-design Considerations:

- solar geometry: angles of incident solar radiation on building components, with diurnal and seasonal alterations (solar azimuth and altitude)
- environmental potential (natural shading by vegetation, protection by built-up neighbourhood)
- orientation of building envelope (wall, roof) according to sun path
- adequate sizing of glazing areas for daylighting requirements
- choice of glazing material (physical properties, dimension, construction)
- placement and operation of effective solar shading devices for the glazing areas (orientation, location, kind, shading coefficient)

# BUILDING SYSTEM OPTIONS

The thermal loads upon building components (external walls, roof, and windows) are generated by solar radiation and heated ambient air. During hot summer periods, even a sun-protected building will be heated up by the heat flow from the outside to the inside. Thus, for heat avoidance, the designer must also follow the same rules of heat transfer as for heat loss reduction:

Pre-design considerations:

- compactness of building form (A / V-ratio)
- environmental potential (earth sheltering, grass roofing, wind protection)
- reduction of transmission gains by (exterior) insulation of building envelope and avoidance of thermal bridges
- shifting of heat flow due to day-night temperature cycles (time-lag of mass components)
- avoidance of infiltration gains by proper tightness of exterior building components

Natural ventilation occurs by differences of air temperature, resulting in rising warm air, and by differences of pressure caused by air movement (wind) at the building surfaces (see Booklet 1, Energy Design Principles in Buildings, sections 7.1, Temperature Gradient Effect, and 7.2, Wind Pressure Effects). Both air movement and the replacement of indoor air by cooler outdoor air may improve summer thermal comfort.

Three functional categories of ventilation can be distinguished:

- **Health ventilation** maintains indoor air quality by replacing stale air with fresh outdoor air. This requirement can be easily fulfilled by opening windows and/or by permanent and controlled infiltration/ventilation devices. The necessary quantities depend on building occupancy patterns, types of indoor activities, and individual user requirements. They are independent of climate conditions and can be indicated in air change rates in m<sup>3</sup> per person (see section 6, Building Codes and Regulations).
- **Thermal comfort** ventilation is provided by simply turning on a fan. This prevents discomfort by evaporating excess moisture from the skin, which then cools the body (see section 4.1, Thermal Comfort).
- **Structural ventilation** is the strategy to cool down certain portions of a building (e.g., attic, rooms) when indoor temperatures are higher than outdoor temperatures.

In hot-humid climates characterized by year round cooling loads during both the daytime and nighttime, passive natural cooling strategies are very limited (see pages 8-9, Energy Design Requirements and pages 74-75). The most effective way to achieve thermal comfort is dehumidification of moist air.

## Heat Avoidance

## Natural Ventilation

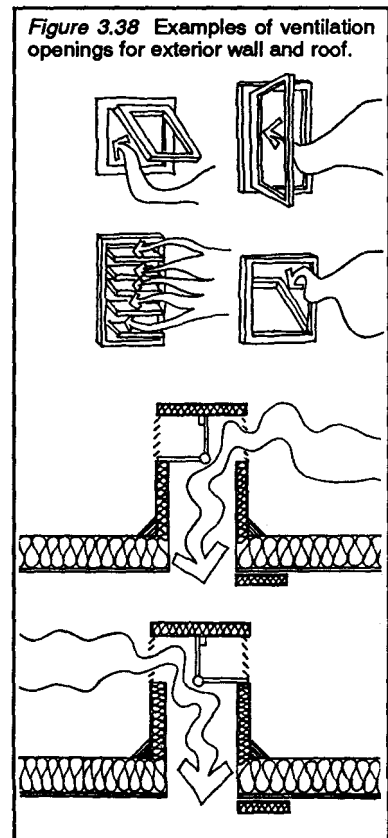

## BUILDING SYSTEM OPTIONS

Unlike permanent health ventilation requirements, the efficiency of thermal comfort ventilation and structural ventilation strategies depend on the conditions of indoor/outdoor temperatures, humidity content and the velocity of the ventilating air.

Direct ventilation during daytime requires a directed air movement through the entire building to provide pleasant cooling. Though the effectiveness on temperature differs, equal outdoor temperatures may cause cooling by convective removal of heat and moisture from the body, comparable with the effect of a ceiling fan.

A permanent air stream is also required for spacial ventilation (room, attic, crawl-space) to avoid an increase of indoor temperature during the daytime. An improvement of daytime ventilation can be achieved by the proper placement of windows and vents related to prevailing wind direction and/or by application of wind turbines or the use of solar chimney effect (figures 3.39 and 3.40)

In order to increase natural cooling effect by decreasing ventilating air temperature, the ambient air can be drawn through underground ducts before entering the space. This concept uses the thermal equilibrium of soil to provide pre-cooled ventilation air in summer and pre-heated fresh air supply in winter.

Depending on building construction, ventilated mass components (ceiling, floor, wall, rock-bed) can serve as storage elements as well. Heat from indoor air is absorbed by cool building elements. This effect can be enhanced by using a fan.

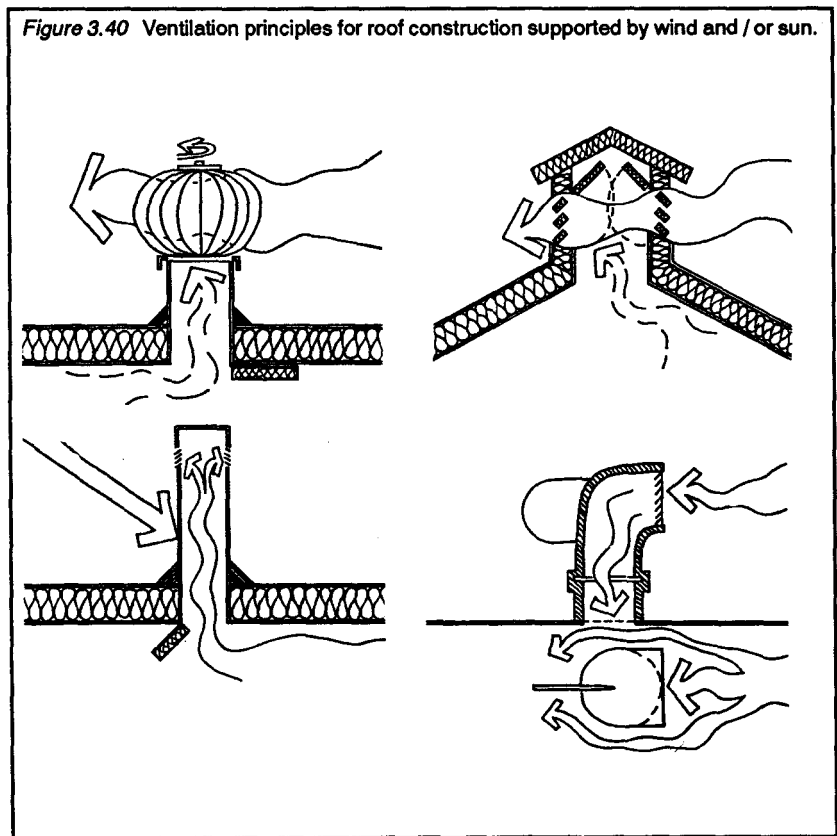
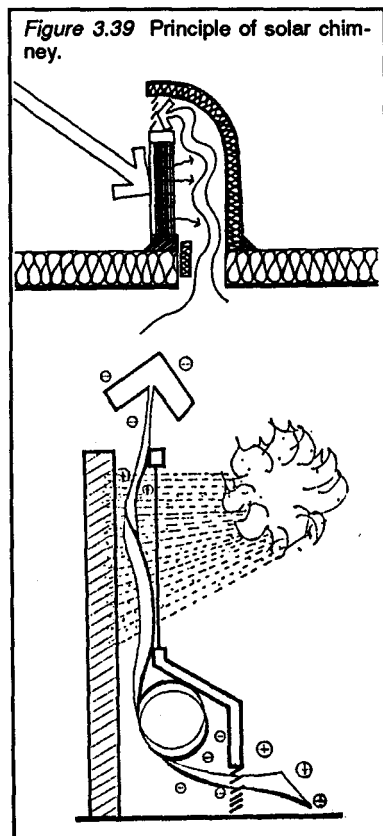

## BUILDING SYSTEM OPTIONS

In climates which are characterized by large temperature changes between day and night (temperate climate, hot-dry climate), nighttime ventilation can be an effective cooling strategy. Depending on the temperature difference, the building and its components are sufficiently cooled at night to eliminate the need for mechanical cooling.

### Principles of structural cooling strategies:

- direct spatial ventilation by windows, vents
- attic ventilation
- vented hollow building components (ceiling, wall, floor, crawl-space, rock-bed)

The simplest way to cool a structure is to open a window. Night air will cool off thermal mass that absorbed heat during the day. Improvement of ventilation can also be achieved by vents facing prevailing winds, and wind barriers which direct breezes to the structure. One of the most important and common approaches is whole-house ventilation. As a typical feature of vernacular architecture of hot-humid climates, it is an appropriate cooling strategy for single family houses of today as well.

For efficient whole-house ventilation the following aspects should be considered during the pre-design stage:

- Sufficient air movement in and out of the home by large net-free areas
- Vents are less efficient and tend to restrict air movement
- Openings should be aligned parallel to prevailing wind direction when gable end louvers are installed
- Proper protection of openings with baffles or louvers to prevent entry of rain and snow
- Location of vents should be chosen independent of wind direction when prevailing wind cannot exactly be predicted or air velocity is restricted by environmental obstacles
- The whole house should be ventilated, including the attic; attics require both high and low vents

For both summer and winter, the attic space acts as a thermal buffer, reducing the residential space to be heated or cooled. For buildings with adequate levels of roof/ceiling insulation, the whole-house ventilation strategy to cool thermal mass directly, is more important than attic ventilation systems.

Structural cooling of ventilated mass components like tubular concrete ceilings and floors, hollow concrete and brick walls or rock-bed constructions provides a significant resistance to air flow. Use of a fan is necessary to provide a sufficient uniformity and velocity of air movement. Different system configurations are shown in figure 3.45 on page 83.

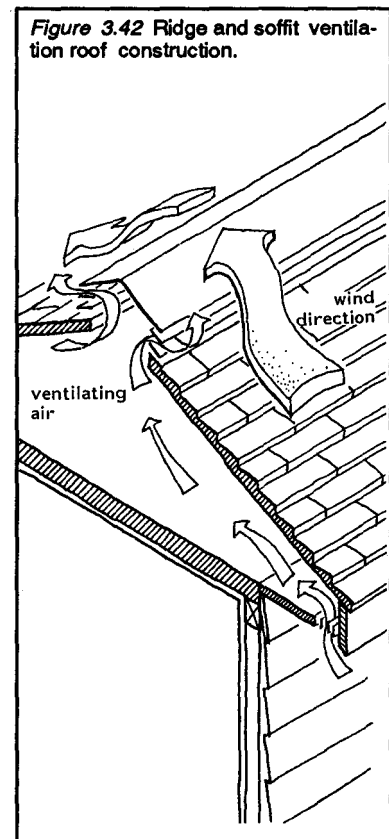

# BUILDING SYSTEM OPTIONS

## Night Sky Radiation

This passive strategy of radiative cooling provides solar heating in winter and cooling in summer. According to the physical properties and principles (see Booklet 1, Energy Design Principles in Buildings) of passive solar heating systems, heat emission can be used for cooling by increasing outgoing longwave radiation from the building at night. However, the application of this principle is limited by particular climate requirements and their impact on architecture and construction:

### Climatic Constraints:

- Cooling occurs only at nighttime, when outdoor temperatures are low. Experience has shown that the temperature swings between day and night should be approximately 15-20 K.
- A sequence of several cloudy nights can decrease the cooling effect. **Architectural Constraints:**

- The radiative cooling components have to provide large surfaces exposed to the sky which can only be achieved by use of flat roofs.
- Radiative systems will only cool directly adjacent spaces. Thus, the system can be utilized for one or two-story buildings. For multi-story residences other systems are more suitable, and system combinations have to be carefully selected.

### Constructional Constraints:

- The roof must have a large thermal capacity exposed to both the interior space for daytime absorption of heat from the indoors, and to the exterior environment for nighttime heat emission.

Figure 3.43  
Roof and radiative cooling principle of the Skytherm® Building in Phoenix, Arizona.

Figure 3.44  
Diurnal development of indoor air temperature for the Skytherm® building in Phoenix, Arizona, 33° northern latitude related to the typical outdoor temperature in August.

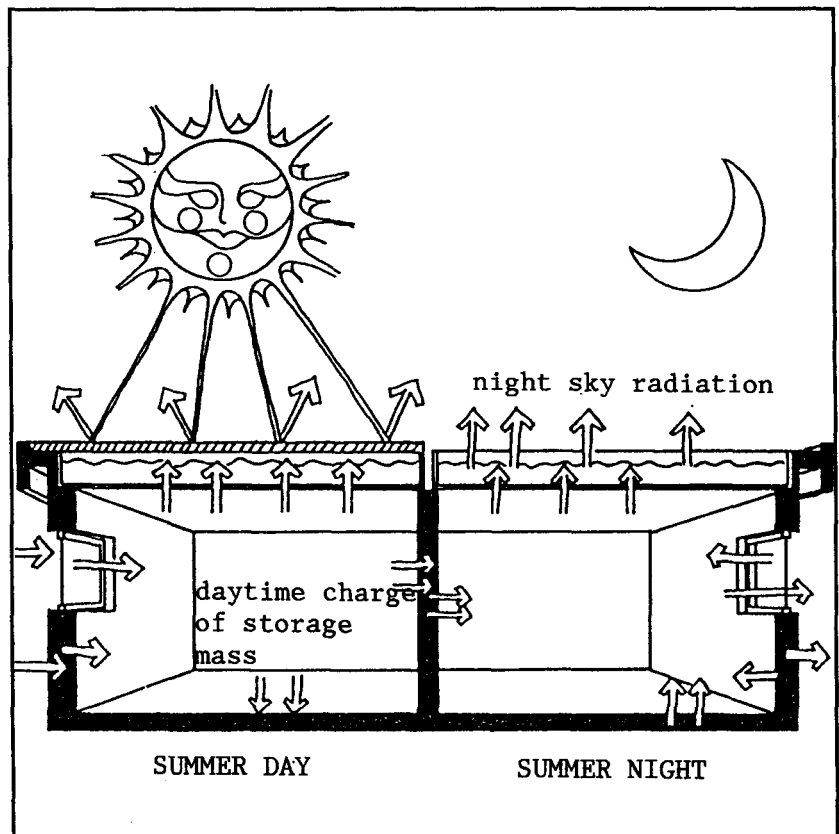
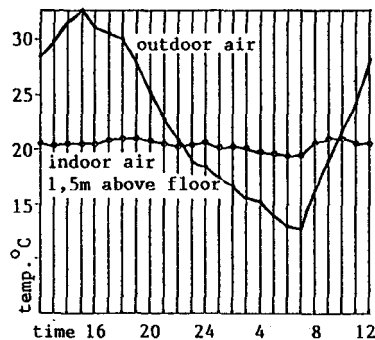



## BUILDING SYSTEM OPTIONS

---

- To avoid daytime solar radiation loads, the storage roof requires an exterior movable insulation which has to be weather resistant and tight. Operation expense and maintenance costs have to be considered to ensure reasonable system performance.
- In order to increase thermal capacity, water bags can be used in the storage roof (roof pond). Beside water's physical properties of high specific heat and low weight, compared to concrete of equal volume (see table on page 50), an increase of roof pond efficiency is caused by the convective heat transmission within the water bags.
- The use of water also causes problems in building construction. Containers must be non-corrosive and leakage must be prevented.

Modifying the moisture content of air will change the dry bulb temperature and the humidity by natural means without additional energy use. For arid regions this strategy can be used to provide cooling of hot outdoor air. This can be achieved by adding moisture with fan-augmented air movement, spraying water, and moving air across large surfaces of water in open pools. In this way, the increased moisture concentration of air will cause a decrease of dry bulb temperature, improving the level of thermal comfort. For reasonable application of evaporative cooling strategies, the following factors have to be considered very carefully:

### Evaporative Cooling

- Desert regions are most suitable for evaporative cooling when air temperatures are extremely high (35-42°C) and humidity levels are below comfort zone (10-20% r.h.).
- The system has to be operated during daytime when cooling demand is mainly needed. Therefore large quantities of air have to be directed through the inhabited spaces.
- Relatively large quantities of water are required during the cooling period. Thus, system application is limited to those regions where sufficient water sources are available (0.3 - 0.5 m<sup>3</sup> per day for an average residential unit).
- Since high air movements must be realized (i.e., by fan-augmented systems), air filters must be used to block out dust-polluted air.
- The addition of moisture to hot air should be controlled to meet the comfort range (see chapter 4.1, Thermal Comfort). Humidification control of indoor air, however, is difficult to realize by passive means.
- The necessarily high air changes causing great variations of air velocity also have to be controlled due to the comfort range.
- Water is the common cooling medium; leakage and corrosion problems have to be taken into account.
- Open pool concepts can be located within habitable spaces and/or on the roof. Open roof ponds will require movable insulation.
- Water areas have to be shaded from solar incident radiation.
- In regions with limited availability of fresh water, salted water can be used. However, the desalination will be required to increase the resistancy of the system construction.

# BUILDING SYSTEM OPTIONS

---

## Conductive Cooling

When two bodies of different temperature are directly connected to each other, the heat transfer will flow through the material from the warmer to the cooler temperature level. This kind of heat transmission is called heat conduction (see Booklet 1, Energy Design Principles in Buildings). The common applications in building construction are earth-sheltered and underground designs. The discharge of heat from building components like exterior walls, floors and ceilings requires direct contact between the building surface and the surrounding ground.

Depending on the climate, latitude, depth, and soil conditions, the ground keeps an almost constant temperature throughout the year. This phenomena can be used for both reducing heat loss in winter and cooling in summer, providing a pleasant temperature balance in winter and summer. Beside the desired heat flow in summer from the occupied space through the walls into the ground, the earth covering serves for heat avoidance (reduction of cooling loads by solar radiation) as well. Specific regard has to be taken concerning:

### **Environmental Factors:**

- maximum annual outdoor temperature gradients
- analysis of soil temperature equilibrium due to depth
- features of soil conditions due to its physical properties: kind, density, conductivity, permeability, average content of moisture, structural stability

### **Architectural Impacts:**

- impact of urban design requirements
- size of building site and integration
- zoning concept of floor plan due to functional requirements of space use and indoor-outdoor correlations (egress, view)
- building organisation according to safety, ventilation, structural stability, fire regulations

### **Construction Issues:**

- structural loads of earth - covered roofs
- conductive exterior wall material
- avoidance of condensation problems by vapor barriers
- protection against water pressure from soil
- drainage of surrounding soil

# BUILDING SYSTEM OPTIONS

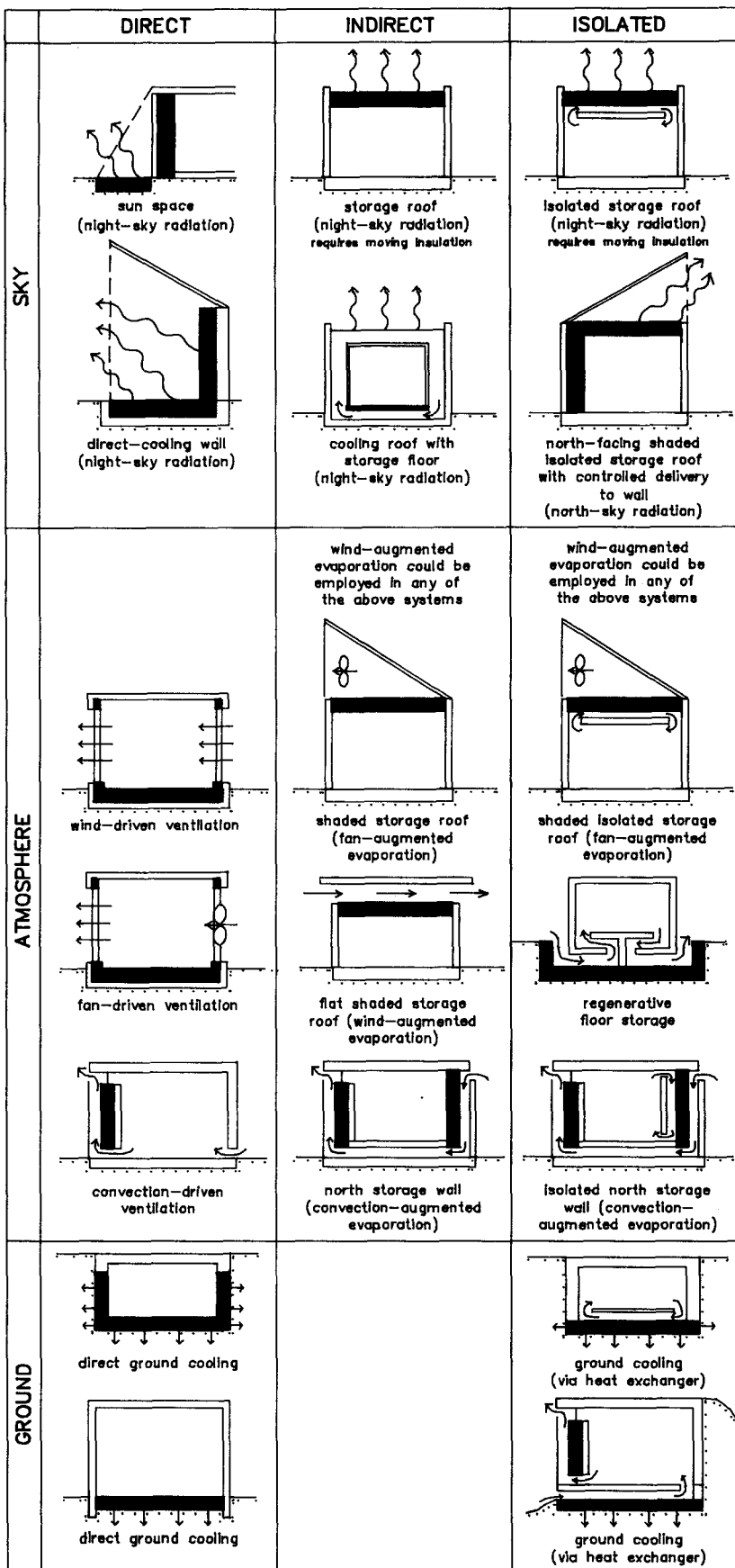

Figure 3.45

Passive / hybrid cooling principles and system configurations.

Passive cooling strategies can be categorized into direct, indirect and isolated systems and can be distinguished by their specific way of transferring heat out of the building.

Radiation to the sky requires large areas exposed to the night-sky providing heat emission from thermal mass. Roof areas are most suitable for indirect systems. Movable insulation, however, is indispensable to avoid overheating by solar insolation.

Convection of cool night air through the whole house and/or its building components will cool down thermal mass in climates with great temperature gradients between day and night.

Conduction of heat to the ground can be achieved by direct contact of floor and walls to the earth via a heat exchange when the spacial building components are separated from ground contact. Attention has to be paid to problems of damp and humidity

# BUILDING SYSTEM OPTIONS

## Passive Cooling Consideration: An Example

In the following example, the performance of a convective cooling system is presented which has been designed and monitored by G.Ludewig, Department of Climate Conscious Design of Technical University of Berlin on behalf of the German Agency for Technical Co-operation (GTZ). The building is located on the Portuguese island of Porto Santo, 33° northern latitude. The climatic features are given in figure 3.46.

The building is used as a research and office building by the Regional Government of Madeira for a desalination plant. To the greatest possible extent the solar house was built with materials obtainable on Porto Santo, with a technology adapted to local conditions.

Objectives of the project:

- The building was to be a pilot project to demonstrate and test passive solar cooling and heating systems in warm and summer-dry regions.
- The intended air-conditioning should be achieved only by passive devices and not by using mechanical devices.
- Only renewable energy should be used for the air-conditioning.
- Appropriate local technologies had to be applied in the construction.
- The architecture had to respect regionalistic features.
- The building was to be equipped with an autonomous water supply.
- A study of users acceptance was to be carried out.

The geometry and disposition of the building were drawn with respect to the local meteorological conditions. The design concept and the building construction minimize the cooling demand in summer and the heating demand in winter. The space conditioning is carried out without any mechanical devices, but only by constructive (passive) means using basic physical principles. Only regenerative energies (sun and wind) are used to operate the air-conditioning which is self-operating and easy to use. The summer daytime cooling is achieved by convective cooling, shown in figure 3.48.

**Figure 3.46**  
Climatic features of Porto Santo, Portugal.

	outdoor air temperature (°C)				
	mean max	max	min	mean min	d/n Δ t
AUG	27.0	33.0	22.1		3.8
FEB	17.8		12.0	7.0	
ANN.	21.1		16.4		

	rel. humid. %	wind speed mean m/s
AUG	73.1	3.4
FEB	78.3	3.2
ANN.	75.4	3.2

sun hours                    2350 h/a  
theoretical maximum    4450 h/a  
annual precipitation      365 mm

	solar radiation on horiz. surfaces $\sum d$ (kJ/m <sup>2</sup> )		
	direct	diffuse	global
JUN	12 069	10 192	22 260
JUL	13 096	9 173	22 233
AUG	13 467	7 457	20 924
DEC	3 786	3 856	7 642
JAN	4 378	4 322	8 700
FEBR	6 277	5 471	11 748
ANN.	9 154	6 725	15 886

An air collector integrated into the vertical south area of the roof is situated above openings in the ceiling and therefore connected with the parent room below. The thermics of the solar heated air inside the collector evacuate the room and produce a sub-pressure, which is balanced by the fresh air entering through an earth-covered tubular register. The earth cover, with an average depth of 1.7 m, keeps the fresh-air-tube on a low temperature level, so that the air sucked through the collector transfers thermal energy and humidity to the tube surface and to the adjacent ground. This way the air entering into the room is cooler and drier than the outside air as it enters the tube. The special advantage of this system is its proportional relationship between incident radiation intensity and systems cooling efficiency. In addition, this system is supported by the prevailing northerly winds increasing the air velocity by negative-pressure of the southern lee-side. Figure 3.49 shows the effect of the convective cooling system (1) in relation to indoor and outdoor air temperatures, in comparison to a nonventilated room without cooling system (2) and a comparable conventional new building on Porto Santo (3). Solar heating in winter is achieved by the direct gain system, intensified by a hybrid system. In 1985/86 the minimal temperature was around 19 °C, whereas it dropped to 15 °C in the reference house.

# BUILDING SYSTEM OPTIONS

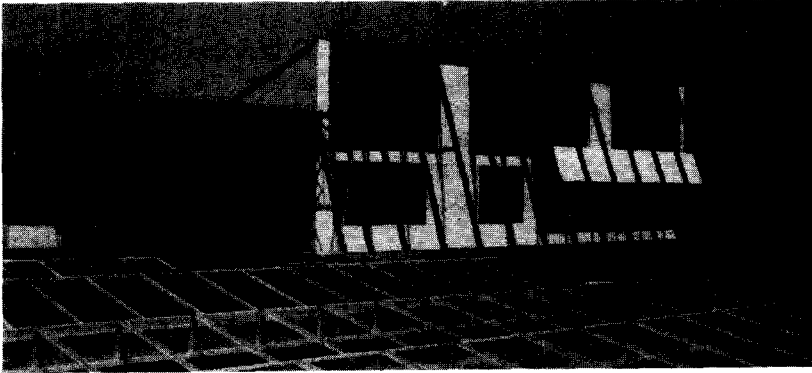

Figure 3.47

Southwest view to the passive solar house with the solar desalination plant in the foreground.

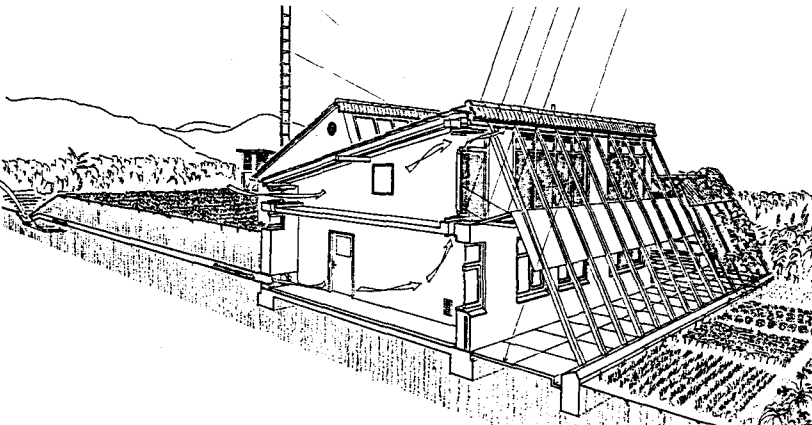

Figure 3.48

Isometric section of the building showing daytime convective cooling operation.

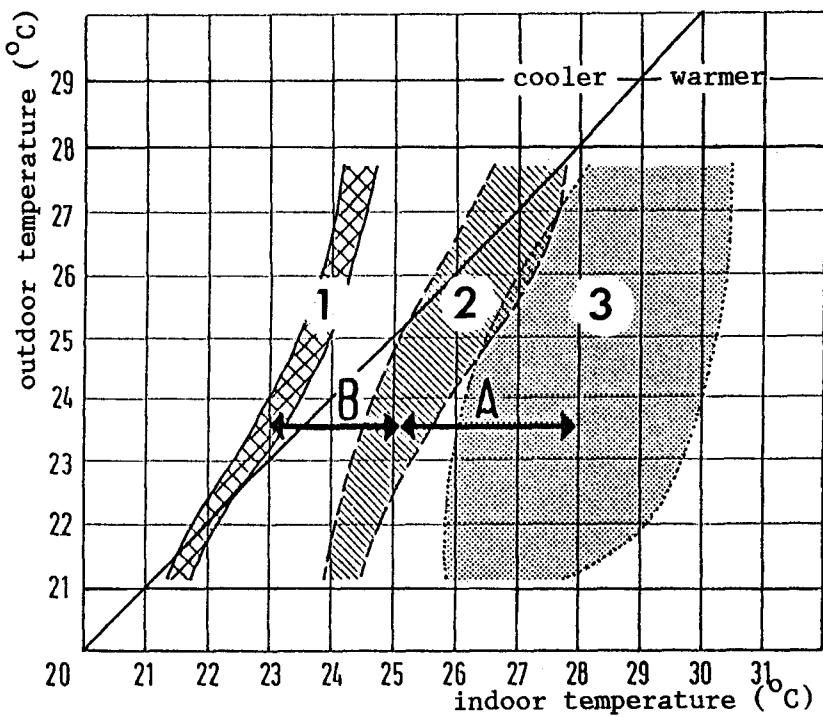

Figure 3.49

Thermal performance of the passive cooling system. The areas illustrate the indoor air temperature ranges depending on outdoor temperature levels for three cases:

(1) represents the cooling mode of the solar house, (2) represents the solar building when the cooling system is switched off, and (3) illustrates the conditions for the reference building which is a conventionally constructed residence.

For a given outdoor temperature of 27 °C the cooling system decreases indoor temperature to 24°C. Turning off the system, the indoor conditions are equal to outdoor conditions, while the reference building with its conventional construction will be heated up to 3.5 K above outdoor level. 'A' represents the decrease of indoor temperature level by constructional improvement of the building, 'B' represents the additional effect of the cooling system itself.

- 1 Solar building with cooling system operation
- 2 Solar building without cooling system
- 3 Reference building (conventional residence)

# BUILDING SYSTEM OPTIONS

In order to optimize cooling system for a particular climate, a reasonable combination of different strategies might be desirable. Therefore, the advantages and disadvantages of each cooling principle have to be evaluated individually. Moreover, the thermal comfort needs must be met throughout the year - thus, cooling strategy and heating strategy for the building design have to be tuned carefully, related to the following:

## Interdependencies

- frequency of switching between heating and cooling mode
- duration of heating and cooling mode
- operation of the same system for both cooling and heating
- architectural impacts of passive systems
- requirements on building construction and material
- compatibility of media for cooling and heating
- availability and efficiency of local energy sources and systems for auxiliary energy supply
- cost / benefit analysis
- evaluation of comfort - related aspects (see figure 3.50)

Cooling Strategies Affecting Comfort Variables	Air Temp.	Mean Radiant Temp.	Air Movement	Humidity
<b>Solar Control</b>				
shading	●	●		
vegetation	●	●		●
<b>Heat Avoidance</b>				
insulation	●	●		
thermal mass	●	●		
zoning		●	●	
<b>Natural Ventilation</b>				
diurnal air ventilation		●	●	
night air ventilation	●	●	●	●
earth-air heat exchange	●		●	●
solar chimney	●	●	●	
<b>Natural Cooling</b>				
evaporative	●			●
radiative	●			
conductive	●	●		
structural convective	●	●	●	

Figure 3.50  
Influences of passive cooling strategies on relevant indoor climate factors.

# BUILDING SYSTEM OPTIONS

The evaluation of passive strategies for both heating and cooling depends mainly on the local climatic conditions. Only a few places on earth have year round thermal comfort. Conditions in cold climates favor heating designs; those in tropical climates favor year round cooling. Building design for temperate and hot climates, however, require more technically sophisticated solutions on the part of the planner. Advantages and passive heating strategies in winter should not be offset by disadvantageous overheating problems in summer. Conversely, achieving summer comfort should not lead to an increase in heating demand and discomfort in winter through leaky construction, thermal bridges or the absence of sunlight.

Conclusion

PASSIVE STRATEGIES	CLIMATE					
	Cold	Temperate Mediterran.	Temperate Continental	Hot Mediterran.	Hot Continental	Tropical
<b>HEATING</b>						
Solar Collection						
glazing component	●	●	●			
opaque component		●	●	●	●	
heat storage		●	●	●	●	
Heat Distribution						
distribution of warm air	●	●	●			
heat discharging		●	●	●	●	
Heat Conservation						
red. of transmission losses		●	●	●		
reduction of infiltration		●	●	●		
zoning		●	●	●		
<b>COOLING</b>						
Solar Control						
shading of window		●	●	●	●	●
building protection					●	●
Avoidance of Heat Load						
reduction of transmission				●	●	
reduction of infiltration					●	
zoning				●	●	
Natural Ventilation						
temperature gradient effect	● <sup>1)</sup>	●	●		●	
wind pressure effect	● <sup>1)</sup>	●	●	●	●	●
Natural Cooling						
air cooling				●	●	
envelope cooling					●	

**Figure 3.51**  
Summary of climate - related suitability of passive heating and cooling strategies.

<sup>1)</sup> natural ventilation concerns fresh air supply



*Figure 3.52*

Multi-story residential demonstration building of IEA Task VIII in Berlin, Germany (see Booklet 6, Passive Solar Homes: Case Studies).

Passive solar features are the south facing air collector on the facade charging a tubular ceiling mass storage, integrated sunspaces and movable insulation and shading devices. The atrium apartments on the upper level are designed to supply the northern spaces by direct solar gain.

Design: IBUS GmbH, Berlin  
G. Hillmann, J. Nagel, H. Schreck,  
co-op P. Kempchen, M. Gldenber



*Figure 3.53*

View from the living room to the sunspace of the IEA Task VIII building. The common wall is totally glazed providing daylight to the adjacent spaces.



The provision of indoor comfort through the purposeful capture, storage and distribution of solar energy at the site a primary goal of bioclimatic design. In some locations, however, energy conservation and passive solar features will not be sufficient to provide year-round comfort. In addition to the need for properly balanced passive heating and cooling strategies, auxiliary energy supply systems are the "third dimension" of energy responsive architecture.

This chapter discusses human thermal comfort and the variety of auxiliary space conditioning options for maintaining acceptable levels of indoor comfort. Of course, the discussion focuses on those heating systems which adapt easily to supplying the limited heating needs of passive solar homes.

The chapter starts with factors important for the evaluation of thermal comfort and internal gains and continues with a discussion and evaluation of passive system / heating system / building system configuration. The suitability of these configurations is illustrated for temperate climates that may require a variety of thermal conditioning options during a year.

For other locations, the matrix structure of this section has to be modified according to the specific local climatic conditions. A detailed discussion of cooling systems has not been included in this section; general requirements and systems are discussed in chapter 3 of this Booklet.



*Figure 4.0*

There is no place like home - provided that physiological conditions will meet occupants' thermal comfort requirements which are fundamental biological needs. The physical environment of living spaces and the application of technical systems are to be designed for the increase of living quality.

# AUXILIARY SPACE CONDITIONING

---

## Checklist

### Thermal Comfort

Define zones of different thermal comfort levels based on:

- air temperature
- surface temperature
- humidity levels
- activity
- air movement

### Heating Strategy

Identify auxiliary heating strategies related to:

- the nature of the building structure (size, U-values, etc.)
- the passive solar system
- internal gains and heat recovery

### Auxiliary Heating System

Evaluate the systems according to:

- availability and environmental evaluation of fuel
- system capacity and efficiency:
  - heat generation
  - heat distribution
  - heat delivery
  - suitability of control
- kind and quality of heat transfer (related to thermal comfort):
  - HVAC systems for heating and /or cooling o convective heating systems
    - radiative heating systems
- assess the application / combination of:
  - heat pump systems
  - active solar systems

# AUXILIARY SPACE CONDITIONING

Most of the world's residential buildings are located in climate zones that require auxiliary mechanical systems for space conditioning. While previous chapters illustrated energy conservation and passive solar strategies to maximize environmental energy input, it is necessary to optimize those systems in concert with mechanical systems.

Building structure, quality of the building envelope, and suitability of passive strategies determine the magnitude of the auxiliary space conditioning demand. However, the actual heating and cooling consumption may vary according to users' behaviour and individual thermal requirements. Therefore, the fine-tuning of mechanical system performance and individual user control are both essential for true energy benefits.

Thus, the evaluation of a heating system has to consider both energy and comfort related aspects to meet occupant satisfaction.

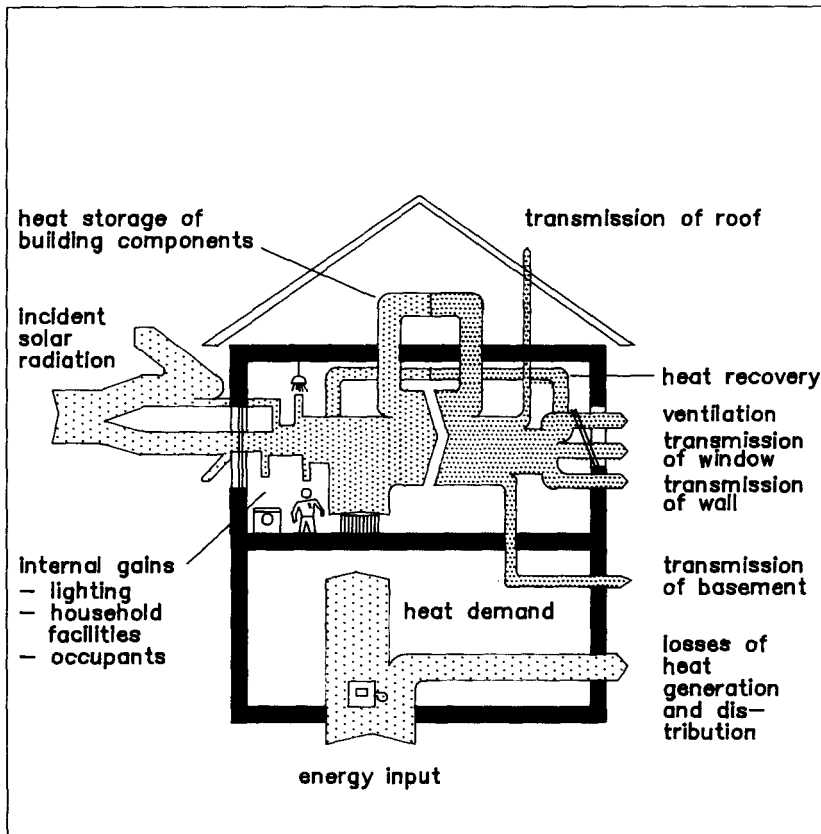

Figure 4.1

Schematic heat balance of a residence: The auxiliary heat demand depends on the building properties, the efficiency of heating system, the reasonable combination of environmental energy use and heat recovery.

# AUXILIARY SPACE CONDITIONING

## 4.1 Thermal Comfort

As it relates to the human body, thermal comfort is characterized by a well balanced relation between heat production and heat transmission (no freezing, no sweating). Heat production depends on the body's activity and muscle movement. Heat transmission depends on clothing levels, temperature of air and surrounding surfaces, relative humidity and air movement. Body temperature can be controlled by physiological processes and behaviour, e.g., by moving into sunshine or shadow, or wearing adequate clothing. Heat is given off from the body by exhalation and through the skin. Heat transmission at the body's surface occurs by dry discharge through conduction, convection and radiation as well as by moist discharge through evaporation.

When heat loss is higher than heat production, the body will be cold. Consequently, the body reduces its heat transport to the surface (skin) by contracting the vascular system (pale skin) and the excessive heat losses will be equalized by muscle vibration (mechanical heat generator--shivering).

Overheating occurs when heat loss is lower than heat production. The body increases its heat transport to the emitting surface by vascular extensions and higher flow of blood. In addition, the heat loss could increase by profuse perspiration (evaporation). When nude, the human body is physiologically adapted to an environmental ambient air temperature of 25°C. Deviations which tend to overheating are more tolerable than those of underheating. In fact, the bearable range of temperature is very small and other decisive factors must be considered in correlation to each other, as shown in figure 4.2.

**Figure 4.2**  
Thermal comfort depending on physical, intermediate, and physiological influences.

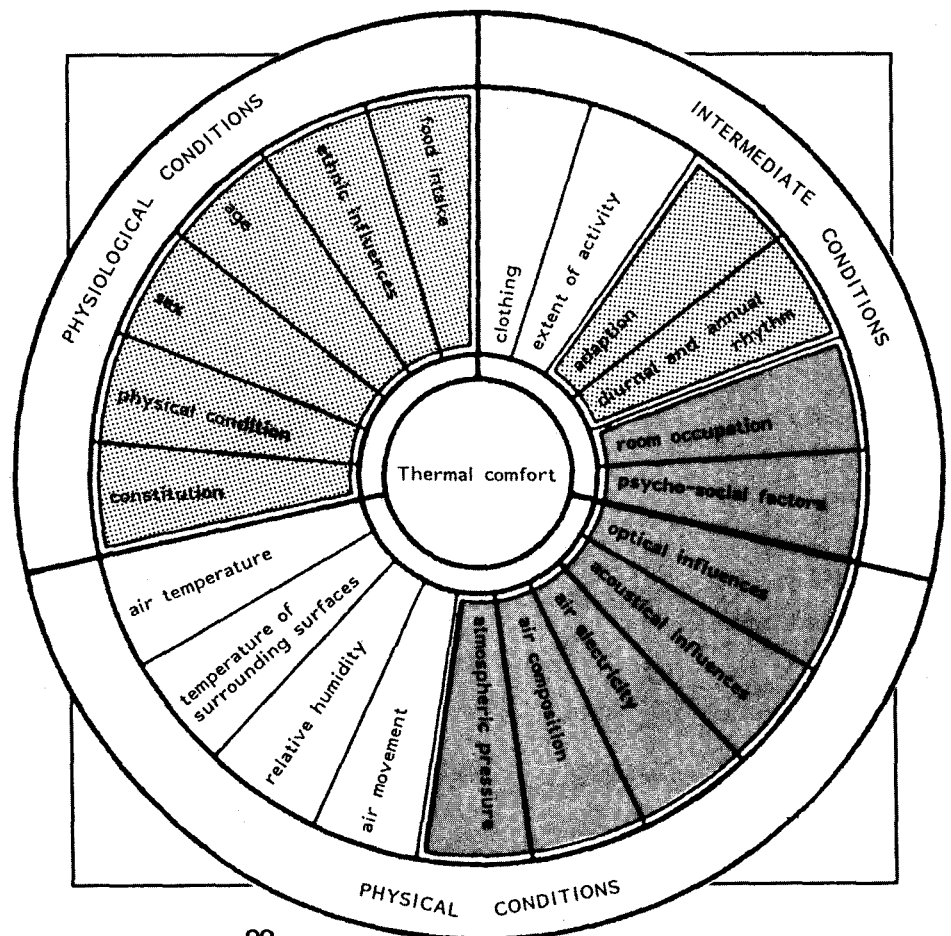
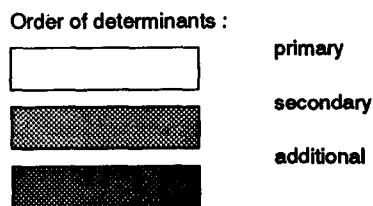

# AUXILIARY SPACE CONDITIONING

## Air Temperature:

Though air temperature (dry bulb) is the most commonly used index for cold or hot room conditions, it is not sufficient for the evaluation of thermal comfort requirements. For instance, the dry bulb thermometer ignores temperature stratification which depends on building system and fenestration properties, and above all, the features of the heating system. Due to the heat balance of the human body, air temperature alone is not an adequate indicator of the real process of heat transfer unless it is tied to such other factors as surface temperature, air velocity and humidity.

**Air Temperature and Surface Temperature**, mean radiant temperature (see figure 4.3):

Radiative heat loss from a person in a room depends on the surface temperatures of the surrounding walls. During the heating season, poorly insulated exterior walls cause low surface temperatures which have to be counteracted by an increase of air temperature. On the other hand, a uniform high wall temperature of 20 °C could allow an air temperature of 18-19 °C to achieve the same comfort level as an air temperature of 23 °C related to a surface temperature of 16 °C. This may have an important impact on energy consumption. As a rule of thumb, the difference between surface and air temperature should not exceed 3 K.

**Air Temperature and Air Movement** (see figure 4.4):

Convective heat transfer from the body is effected by the temperature and flow speed of surrounding air. High air velocities (above 0,2 m/s for a sedentary person) increase the heat loss of the body when air temperature is below the comfort range and will be sensed as cold air draughts. If the temperature is slightly above comfort level, however, air movement can effect pleasant cooling by increasing convective and evaporative removal of heat from the body. Temperatures distinctly above skin temperature suppress convective heat loss but increase discomfort by convecting heat from the environment to the body. At that point, evaporation is the body's only way to lower its temperature, and only if the surrounding air can absorb the removed moisture.

**Air Temperature and Humidity** (see figure 4.5):

Numerous physiological investigations have shown only a minor impact of relative humidity (%) on thermal comfort. Variations of relative humidity of 30-60% related to a comfortable temperature range of 19-23 °C will maintain the same comfort level. More crucial for discomfort is a combination of hot and humid air, which will reduce the evaporation of the body and provide sweating. Extreme conditions would even seriously burden the circulation of blood. On the other hand, high humidity levels of air in concert with low temperatures could cause moisture and condensation problems which can only be counterbalanced by sufficient ventilation of indoor space. An ideal indoor climate should be targeted to 40-60% relative humidity at 20 °C air temperature. Lower humidities cause another problem, dry and hot air; this can upset the body's moisture.

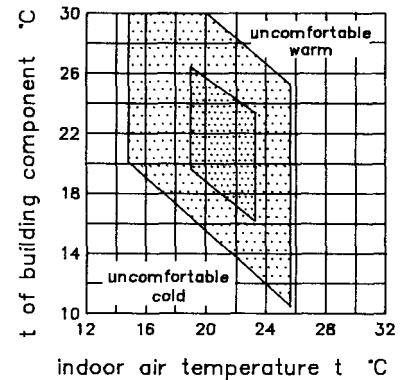

Figure 4.3

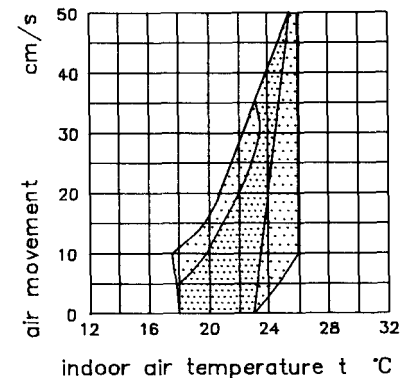

Figure 4.4

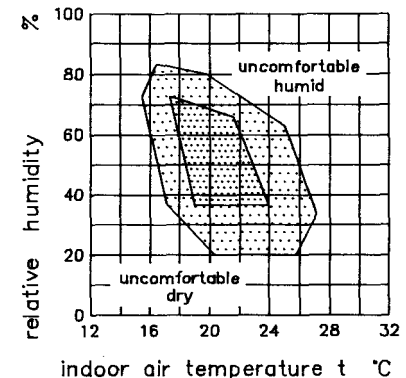

Figure 4.5

## AUXILIARY SPACE CONDITIONING

balance of the body, drying the skin and burdening respiration. Moreover, air polluted by dust could produce a negative stimulation of mucous membranes of the throat. Thus, a minimum level of humidity is required and should be considered for both passive heating and cooling strategies and for the selection of the auxiliary heating system.

### influence of Human Activity:

The body's heat production is generated by metabolism and the movement of muscles. Aside from quality and quantity of food, which is also responsible for human well-being, the amount of converted energy depends on the activity level of the body. The amount of the produced energy is expressed in Watts per m<sup>2</sup> **body surface, called the metabolic rate (1 met = 58 W/m<sup>2</sup>)** defined for different activities. The sedentary state of man can be determined as a neutral or standard state of activity level (1 met). Lower activities, such as sleeping, or higher ones, such as walking, working, or gymnastics generate corresponding amounts of energy (see figure 4.6).

Thus, human activity influences the requirements on thermal comfort by shifting the comfort zone. In other words, determined by the metabolic rate the individual tolerances straying from standard thermal comfort patterns tend to those conditions which support adequate heat exchange and control.

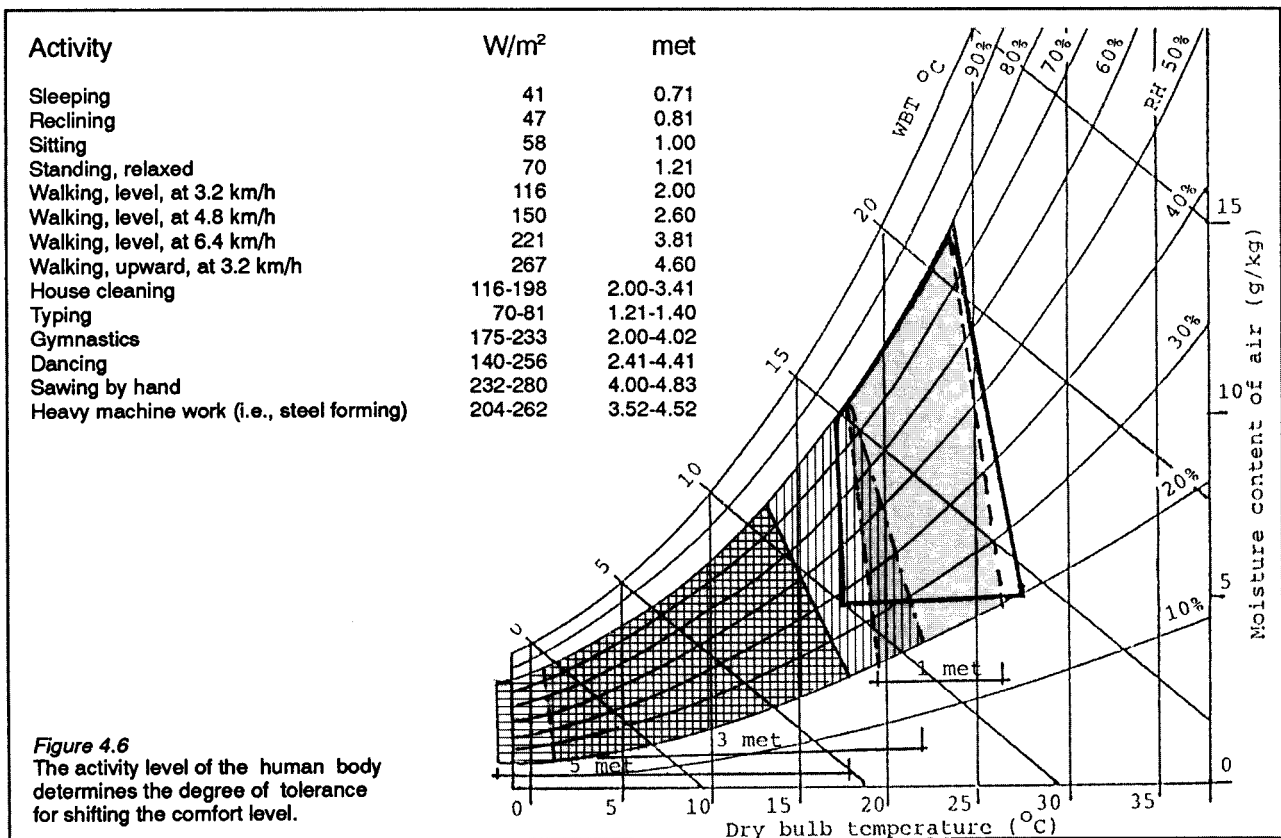

# AUXILIARY SPACE CONDITIONING

## Influence of Clothing Habits:

Clothing habits are determined by cultural norms and climatic variables. From the thermal point of view, clothing provides resistance and protection against environmental influences (wind, rain, irradiation, heat, cold). Due to the thermal resistance of insulation material, which is determined by the R-value in  $m^2K/W$ , the thermal quality of clothing is expressed in clo units (1 clo =  $0.16 m^2 K/W$ ) based on a common business suit. Based on the environmental conditions (temperature, humidity) clothing levels will vary as they do according to activity levels. Thus, a deviation from the comfort zone may occur as well.

For residential building design, the influences of human activity and clothing habits of occupants are of minor importance for the sizing but essential to the control of a heating system.

Since variations of occupant's habits require modified thermal conditions, changing comfort levels by thermostat control should be an easy process. The best control is provided by a thermostat located in each room, controlling an individual quick-response heating element for that room. To maximize heating season performance, the occupant should be provided with complete instructions for using the heating system. (see chapter 5, User Influence, and Booklet 8, Post Construction Activities).

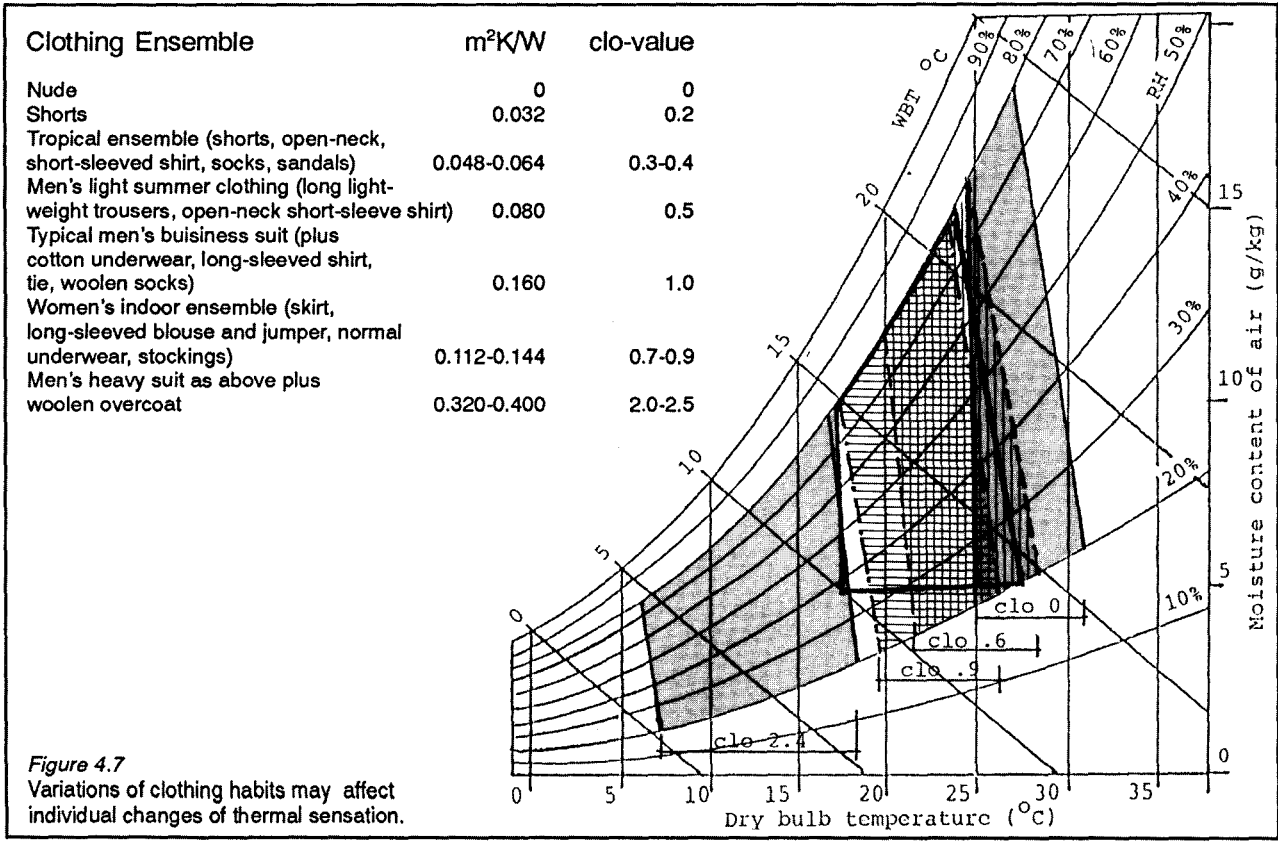

Figure 4.7  
Variations of clothing habits may affect individual changes of thermal sensation.

# AUXILIARY SPACE CONDITIONING

From the physiological point of view, thermal indoor comfort requirements can be narrowed to a certain range based on occupants' comfort tolerances. However, these tolerances may be very individualistic. Therefore, the design conditions have to relate to standard requirements determined by environmental variables, neglecting personal variables to a certain degree. From the energy consumption point of view, however, the influence of occupants' behaviour and acceptance is most important for the energy performance of the building (see section 5, User Influence). Since passive solar homes depend on particular characteristics of solar energy collection and distribution related to different strategies, the variations of comfort levels have to be seriously considered through a more complex process to avoid discomfort.

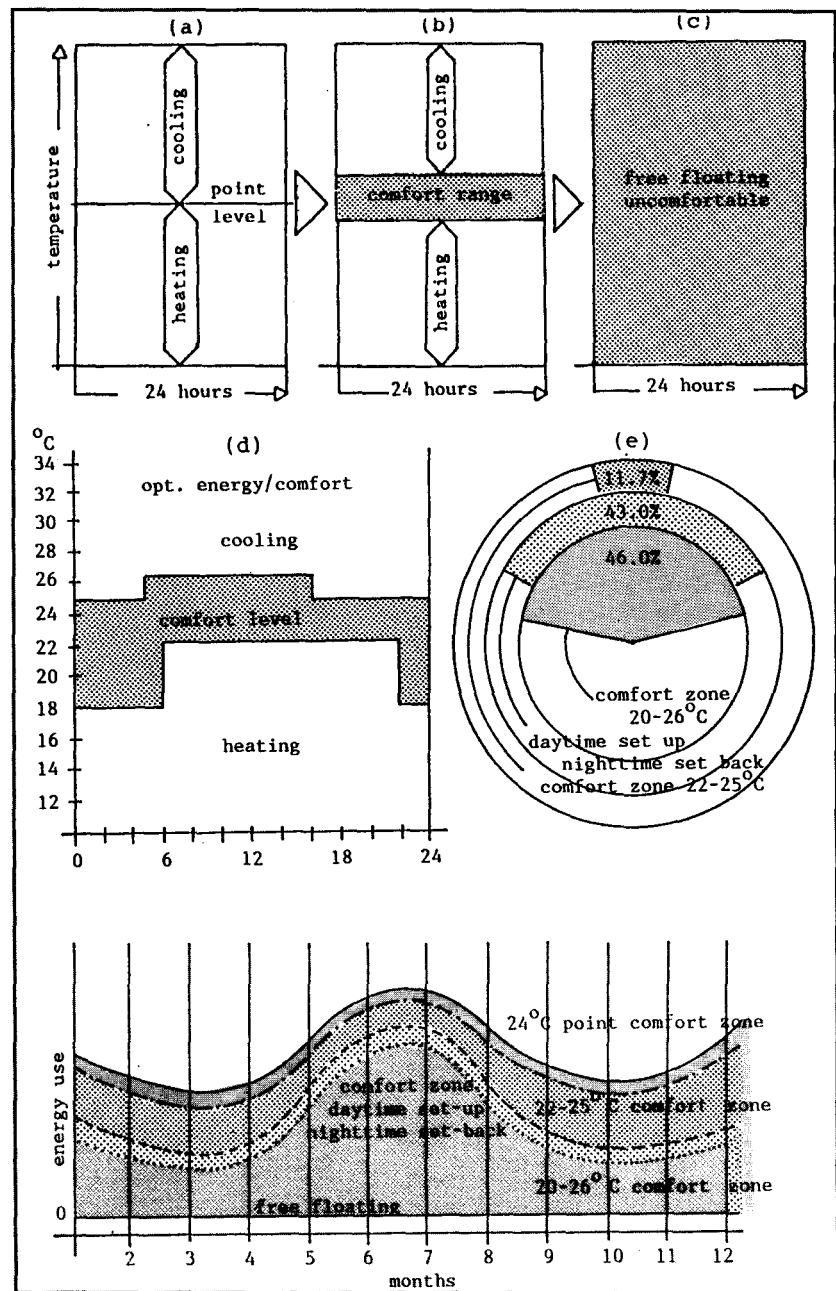

Figure 4.8

Personal tolerance determines the degree of comfort and affects energy consumption as well:

High energy consumption for heating and cooling is required when comfort level is pointed at a certain temperature (a). An extension of the comfort zone by a certain range decreases energy consumption (b). Depending on the degree of the tolerance, the most extreme situation is non-energy consumption by free floating conditions but also causing discomfort (c).

Day and night thermostat settings will alter the comfort ranges due to the building's diurnal occupancy decreasing the expense for heating and cooling (d). Figure (e) shows the percentage of energy saving due to different ranges of comfort zones related to the pointed 24 °C level (example MED house, Davis, California).

The energy demand varies on a daily and yearly basis. Energy savings can be achieved by daytime set ups in summer and nighttime set backs in winter. Due to the climate causing the degree of heating and cooling loads the designer and the occupants should consider the principle of moving comfort zones.



# AUXILIARY SPACE CONDITIONING

If a building's heat demand has been reduced to a very low level by excellent thermal quality of building components (insulation, windows, and so on), the influence of internal gains increases during the heating season.

Annual mean values of internal heat gains are easily determined but only a portion can effectively reduce the total energy consumption of a residence. The daily fluctuation of internal heat generation varies considerably, depending on existing household facilities and user behavior. Moreover, the internal heat gains are not steadily distributed over the entire floor area but are concentrated primarily in the kitchen and secondarily in the living room. In cases of high internal heat generation, mostly by cooking, the ventilation demands preclude effective use of these internal gains. Without heat recovery or mechanical ventilation systems, the heat content of air would be lost. Average annual values for internal gains which are commonly considered for residential energy analysis are about 1.4 kWh/d per person and 8.4 kWh/d for electrical energy, or a total of 14 kWh/d related to a four person household.

Heat demand and internal heat generation do not always occur at the same time. Depending on the amount of internal gains three strategies of utilization are possible:

- use of thermal storage capacity of building components (inertia of mass units),
- distribution or shifting of heat to other spaces which require heating, and waste heat recovery.

## 4.2 Internal Gains

**Figure 4.9**  
Internal heat gain generation of different sources due to daytime utilization. The totals include internal gains of lighting, occupants, and other sources as well.

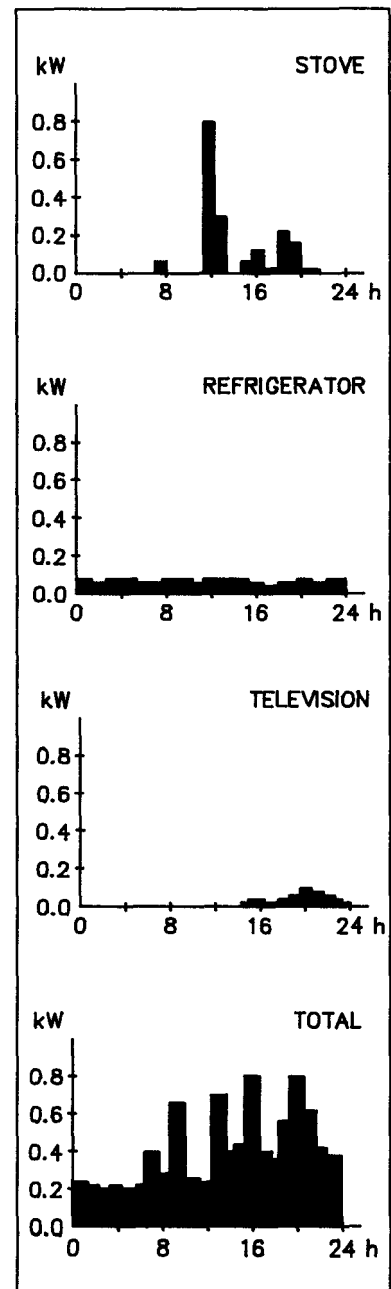

**Figure 4.10** Annual fractions in kWh and special distribution of internal heat gains of a typical average residential unit.

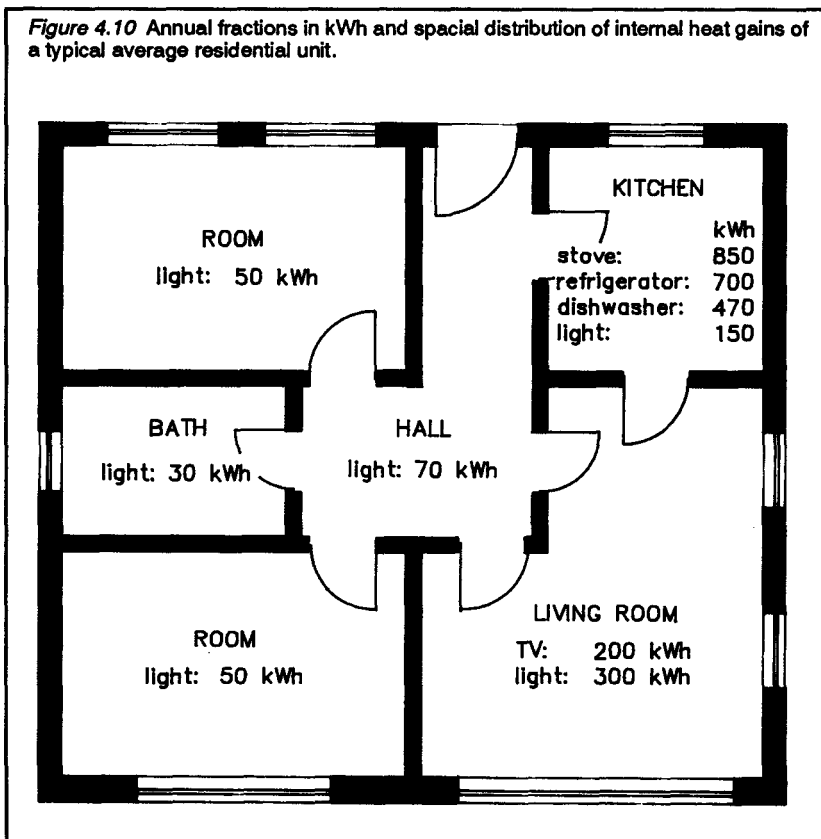

# AUXILIARY SPACE CONDITIONING

## 4.3 Selection of Auxiliary Heating Concepts

**Figure 4.11**  
Qualitative variations of indoor air movement depending on insulation level and heating system (kind, location of heat emitter, inertia).

### CONVENTIONAL INSULATION LEVEL

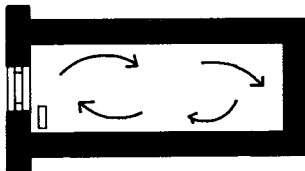

convective heating system

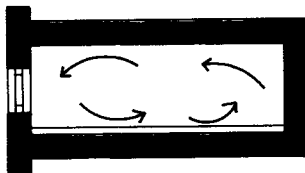

floor heating system

### SUPER INSULATION LEVEL

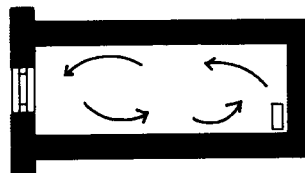

convective heating system

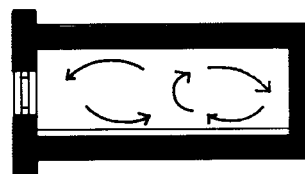

floor heating system

Aside from economical considerations and the aspect of the availability of energy sources, the kind of heating system is directly linked to the building system. Generally, heating systems can be categorized by two basic types: fast response systems which enable a quick adjustment to changing temperature levels of the space and slow response systems which react very slowly upon thermal spacial variations in temperature. This concerns essentially the kind and construction of heat emitters and controllers. Another important factor is the heat distribution in the room characterized by temperature gradients which have an impact upon thermal comfort. A classification of those different types will be given in figure 4.15 on page 104.

For the actual selection of the heating system, however, the building system must be taken into account to evaluate the thermal building performance. The thermal features of the building system (see chapter 3, Building System Options), its thermal storage capacity, the location and distribution of storage mass, all interact with the kind of heat delivery. Figure 4.12 shows the advantages and disadvantages of the building performance depending on Building System vs. Heating System.

Depending on the individual design requirements, the positive features of a certain configuration may contradict the other aims of the overall design. Also, the advantages and disadvantages have to be checked against each other due to the seasonal variations of thermal requirements of heating, cooling, heat avoidance, overheating problems, ventilation, the tendency to draft air, and so on.

The knowledge of these features of system combination is an essential indicator for the selection of building integrated passive solar and auxiliary space conditioning strategies.

BUILDING SYSTEM	HEATING SYSTEM	
	fast response	slow response
<b>BUILDING PERFORMANCE</b> 		
<b>LIGHTWEIGHT CONSTRUCTION</b> 	<b>POSITIVE FEATURES:</b> -extremely short start heating -quick response to free heat -efficient night setback  <b>NEGATIVE FEATURES:</b> -storage of free heat not possible -easily overheated in summer without shading -tendency to produce indoor draft -tendency to uncomfortable dry air	<b>POSITIVE FEATURES:</b> -effective night setback if time-lag considered  <b>NEGATIVE FEATURES:</b> -no storage of free heat -quick overheating in summer -no response to free heat -extended cooling down periods after ventilation (long start heating)
<b>HEAVYWEIGHT CONSTRUCTION</b> 	<b>POSITIVE FEATURES:</b> -quick start heating -reduction of cooling loads -reasonable storage of free heat i.e. solar gain, internal gains -free heat immediately replaces heating system -no cooling down effect during ventilation  <b>NEGATIVE FEATURES:</b> -reduced night setback efficiency -tendency to produce indoor draft -increased difference between air and surface temperature	<b>POSITIVE FEATURES:</b> -reduction of cooling loads in summer with night time ventilation where possible -high thermal comfort during ventilation -good relation of air temperature and surface temperature -favourable conditions of indoor humidity level  <b>NEGATIVE FEATURES:</b> -long start heating -free heat causes overheating -inefficient night setback

Figure 4.12

# AUXILIARY SPACE CONDITIONING

The following matrix (figure 4.13) serves for evaluation of energy performance and thermal comfort of passive solar heating systems versus building system, heating system and heating mode. The evaluation applies to temperate climate conditions because in this climate the variety of thermal comfort requirements is most complex in comparison to other climates; furthermore, the whole range of the possible different passive solar systems can be used in temperate climates, which adds to the complexity. Also, the different building and heating systems are common practice in new home construction.

For other climate zones the evaluation of the suitability of passive solar systems has to be modified due to the major climatic features and the resulting design requirements upon heating and cooling. Moreover, the selection of the building system has to relate to the regional traditions and common techniques of construction technologies.

### Interpretation of the Matrix:

The scale evaluation concerns two aspects: **energy performance** and **thermal comfort**. This distinction is reasonable and essential because a heating system designed for maximum energy benefit would not necessarily provide the best thermal comfort, and vice versa. Similar to the discussion of passive solar system performance for winter and summer conditions, and the issues of building systems and heating systems, the interdependencies of the overall energy strategy combining and using environmental, internal, and auxiliary energy sources should be carefully evaluated due to the individual design requirements.

BUILDING FEATURES		PASSIVE SYSTEM				
		DIRECT GAIN	STORAGE WALL <sup>1)</sup>	AIR COLLECTOR <sup>2)</sup>	SUNSPACE <sup>3)</sup>	
BUILDING SYSTEM	LIGHT-WEIGHT CONSTRUCTION	heating system fast response	+	++	++	++
		intermittent	o	+	+	+
		constant	-	o	o	o
		slow response	+	+	+	+
	MASS CONSTRUCTION	heating system fast response	+	+o	+o	+o
		intermittent	+	+	+	+
		constant	o	o	o	o
		slow response	+	++	++	++
		heating system fast response	+	+	+	+
		intermittent	+	+	+	+
		constant	o	o	o	o
		slow response	+	++	++	++

Figure 4.13 Evaluation matrix of energy performance and thermal comfort of passive solar heating systems. This illustration applies to temperate climates.

energy performance		thermal comfort
Scale of evaluation:		
<b>Energy</b>		<b>Comfort</b>
very good	++	high level
good	+	pleasant
practicable	o	neutral
problematic	-	problematic
not suitable	--	uncomfortable

- <sup>1)</sup> The storage wall has double glazing and movable insulation or is equipped with translucent insulation.
- <sup>2)</sup> The system consists of a collector charging a hollow mass construction.
- <sup>3)</sup> The sunspace contains a mass floor and ventilation flaps to the adjacent space (heat gain in winter) and summer ventilation and sufficient shading is provided as well.

## AUXILIARY SPACE CONDITIONING

The Ideal" energy design strategy combines an excellent energy performance with a high thermal comfort level. For temperate climatic conditions, however, the seasonal and often contradicting requirements show that the designer has to set priorities in favor of energy performance or thermal comfort.

- Depending on how one uses the matrix, it will help select the adequate passive solar strategy for a pre-conditioned building construction and/or heating system.
- For example, if one starts by selecting a passive solar system, the matrix indicates the optimal building system and heating system features.
- To optimize performance, the indirect passive solar systems - storage wall, air collector, and sunspace - work best in lightweight buildings when combined with a fast responding heating system and intermittent heating mode (++). The advantage of this system configuration results in an instantaneous displacement of the space heating by a controlled solar energy supply.
- Conversely, the worst system configuration is a direct solar gain system serving a lightweight construction equipped by a slow response system without night setback. In this case, energy savings can hardly be realized, and even on a sunny winter day overheating could occur, decreasing thermal comfort.
- To optimize thermal comfort in a high-mass building, constantly heated spaces are generally desirable because night setback would cool down the building mass (++). To improve thermal comfort conditions for an intermittent heating mode, a fast heating system should be chosen which is also reasonable in combination with the passive solar system application.
- There are only minor differences among the evaluation of suitability of the indirect passive solar systems themselves. This is because all indirect system performances are characterized by similar features of not directly interacting with the building construction.
- For the individual design, a combination of different systems may be a reasonable solution to meet both energy efficiency and thermal comfort. Combined solar energy strategies are designed to profit from the main advantages of each category involved.

**Figure 4.14**  
Periodic heat emission of passive solar systems.

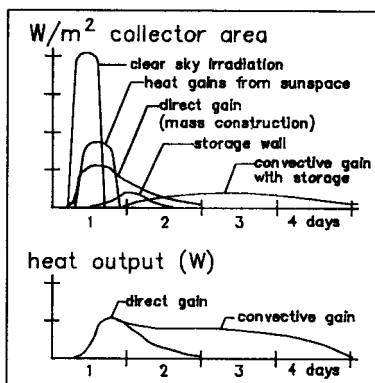

The selection of combined solar system configurations requires the knowledge of the timing of heat delivery to room air by each passive solar system (see figure 4.17). Attention has to be paid to the compatibility of the selected systems.

While direct gain systems and sunspaces, for instance, are of similar energy performance relative to their timing of generation to heat from the sun, they will compete with each other unless they are separated.

By contrast, direct gain and convective gains, via air collectors or window collectors are perfectly complementary to each other as shown in the lower graph of the adjacent figure.

# AUXILIARY SPACE CONDITIONING

---

## 4.4 Auxiliary Heating Systems

Mechanical systems for space conditioning (heating and cooling) maintain indoor comfort by the use of energy-consuming equipment. The majority of the populated areas of the world today cannot manage human comfort standards without additional expense of mechanical heating and cooling applications. While previous chapters discussed principles to minimize the energy demand and to maximize environmental energy potential by passive solar systems, and their suitability versus building structure, the following section deals with features of mechanical systems supporting an overall passive solar strategy to achieve comfortable and energy saving residences.

First of all, it should be mentioned that the complexity of the relevant energy issues cannot result in a recipe for passive solar strategies (see matrix on page 99). Above all, the discussion should be understood as a contribution of evaluation factors supporting the designer's awareness and decision-making process.

### General Requirements on Auxiliary Heating Systems:

- Heating systems directly influence only two environmental variables of thermal comfort: air temperature and surface temperature (mean radiant temperature). The effects on humidity levels, air velocity and air quality are indirect and depend on the heating system components (heat emitters). The mean radiant temperature should be uniform in spatial and temporal development, about 19-22 °C, tolerating 1 K.
- Heating systems should be controllable. That is, the mean radiant temperature is adjustable according to individual users' comfort requirements. The system should respond quickly to temperature variations from free heat sources (internal loads, solar irradiation) and to sporadic use of a space.
- Heating systems should not degrade air quality by generation of dust, unhealthy combustion, gases, irritating noise, and draughts. Heat emitters should be easily maintained.
- Heating systems should be cost effective in installation and maintenance expenses.

General

An ideal heating system which meets all those requirements does not exist. Even though mechanical air conditioning systems are characterized by drawbacks (operating expense, generation of noise), these systems theoretically provide the widest range of influences on thermal comfort parameters, both for heating and cooling. In fact, the selection of heating systems depends on many factors such as building system, utilization patterns, occupancy, fuel availability, cost of plant, operation, and so on.

# AUXILIARY SPACE CONDITIONING

---

## System Categories

A heating system can be divided into different categories, characterized by its:

- source of heat: coal, natural gas, liquified gas, fuel oil, electricity, wood, solar energy and heat pump systems
- location of heat generation: room by room heating, central heating, district heating
- medium of heat transport: warm water, hot water, steam, air heating
- features of heat transfer: convective heating, radiative heating, air heating, combinations

Of course, there are certain technical interdependencies between these categories which limit combinations to reasonable configurations. However, a complete discussion of all the total varieties of heating concepts is outside the scope of this booklet. Thus, the following subsection focuses on the factors relevant to a general evaluation of suitable heating systems and system components.

## Particular Requirements

Heating system selection according to a low energy and passive solar building concept creates a particular challenge for the designer. Unlike conventional building design, the special nature of this mission is characterized by more sophisticated requirements:

- potential of energy sources on building site (availability, choice)
- the heating system has to provide auxiliary heat of variable intensities
- different spaces have to be supplied at different times (users life-style and spacial occupancy)
- the building concept itself and its thermal properties are part of the heating strategy
- the performance of the selected passive solar systems define particular requirements upon control systems
- the kind of heat distribution (heat transport medium)
- the method, sizing and location of heat storage
- the provided passive controls (movable insulation, ventilation)
- different individual occupant comfort tolerances
- users' acceptance of control and maintenance
- cost investment of heating system related to passive system costs
- cost comparison of different heating systems based on energy source, sizing, and operation modes
- cost analysis of energy consumption, maintenance and energy price (lifetime cycle)

## AUXILIARY SPACE CONDITIONING

---

The process of selecting a heating fuel is important. Aside from conventional decision factors such as economic considerations and thermal comfort requirements, today the ecological factor should be a priority when selecting the fuel for bioclimatic and environmental-responsive design.

### SELECTION AND EVALUATION OF FUEL

Finite supplies, political and economical problems relating to this non-renewable energy source have been the main reason for energy saving efforts and the necessity for substitution over the last few years. Increasing environmental levels by SO<sub>2</sub> pollution and the global decrease of fuel consumption have brought about technical improvements of boiler technologies as well.

Liquid Fuel

From the ecological point of view natural gas and/or liquid gas should be the favored fuel choice. However, it may be slightly more expensive. The most exciting developments of boiler and furnace technology are taking place in this field.

Gas

Though it is a renewable energy source, from the ecological standpoint its use is very controversial. Burning wood depends on an adequate combustion chamber which guarantees minimum air pollution. For rural areas this technology might be an advantageous solution.

Wood

Because of the sulphur and dust pollution of exhaust gas, coal should only be used for domestic heating purposes for exceptional conditions. Burning coke is less serious because the sulphur concentration has already been expelled in the coking plant.

Coal

Electrical power is the most valuable kind of energy. Thus, it should not be used for low energy purposes such as space heating and/or domestic hot water heating. Most of electricity, however, is generated by fuel, coal, gas, or nuclear energy plants, causing environmental pollution. However, use of waste heat recovered as a byproduct of electric generation is a sound space and water heating strategy.

Electricity

Every heating system is characterized by different components which should be considered when evaluating system efficiency (see figure 4.15):

### SYSTEM EFFICIENCY

- heat generation unit
- heat distribution system
- heat emission units
- control unit

Depending on the complexity of the system these functional components are more or less separated in a building and each component is determined by its own seasonal and peak efficiencies affecting the energy consumption.

Example: A gas furnace of a central heating system in the basement with an insulated copper water pipe system which emits heat by an in-slab floor heating controlled by a weather responding thermostat unit. In this case, the overall system efficiency is the product of the individual component efficiencies.

Capacities of heat demand depend on the heat losses of a building caused by transmission through the exterior wall and ventilation/infiltration losses. Boilers of conventional buildings are commonly oversized as

# AUXILIARY SPACE CONDITIONING

Improvement of efficiency:

- central location of chimney to profit from heat losses
- recuperation of gases if possible
- insulation of boiler if necessary
- operation temperature should be as low as possible

they are mostly centralized systems and designed for peak demand. Passive solar low energy buildings are characterized by low transmission heat losses - hence lower peak demand - in comparison to conventional residences. Heat stored in a tightly built, super insulated mass building, would sufficiently balance a rapid fall of outdoor temperature to allow the down-sizing of the heating plant.

On the other hand, an undersized slow-response heating system might cause discomfort in a heavily massed building that was allowed to cool down during a long period of cold weather (see figure 4.15).

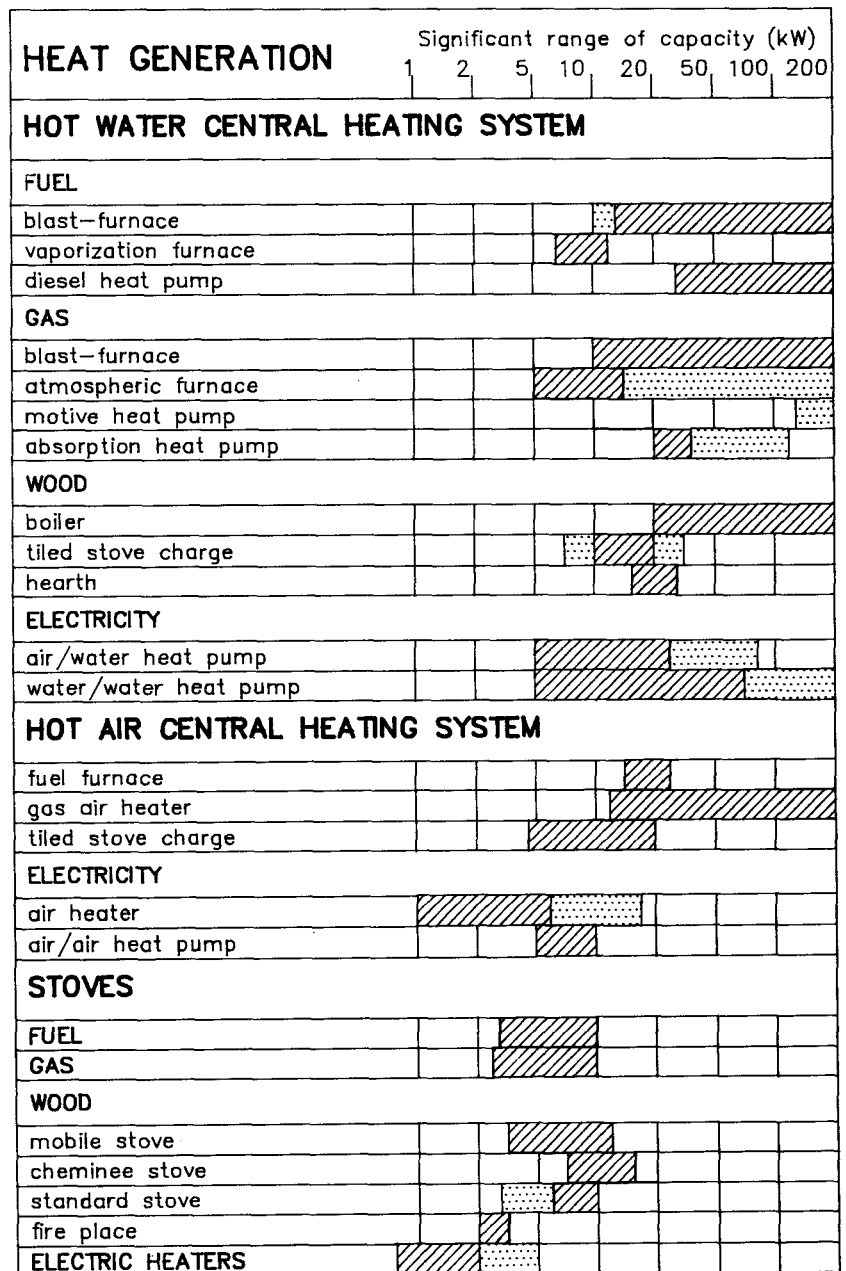

**Figure 4.15**  
Typical ranges of reasonable system output of different mechanical heating systems.



## AUXILIARY SPACE CONDITIONING

---

- The auxiliary heating system should be sized conventionally without consideration of solar gains, using winter design conditions. The effects of passive solar gains mainly result in a shortening of the heating period and a substitution for the heating system during transition periods. Solar gains during cold winter days do not justify an undersizing of the heat production unit. These solar benefits should rather be carefully considered when selecting the appropriate type of heat delivery system and the response of heating controls (see also chapter 3, Building System Options and chapter 4, User Influence). However, significant oversizing should be avoided.
- Central heat generation covering the full range of outputs: Design output should include start-up heat requirements as well. Problems may occur when trying to specify and purchase low-output oil furnaces since they are not yet commonly available on the market.
- Even small boilers for low energy buildings are often over-sized. Thus attention has to be paid for long-term furnace operation when modern boiler technology of low stand-by losses is used. Dual or multiple levels of output of heat generation provides optimum adaptability of heat capacity and corresponding heat demand for most of the heating period.
- Peak and off-peak heating systems have to be designed very carefully to meet the requirements of both operation components. An off-peak system could be a central heating system or monovalent heat pump system without buffer storage according to the effective heat demand, or slightly undersized to meet the basic heat demand. In addition the peak-demand could be covered by a wood stove.
- The evaluation of single stove heating depends on the fuel used in the system. Liquid fuel, gas and electrical stoves operate continuously and their output can be adjusted to meet the actual demand. Wood burning stoves should be designed on a larger scale (two - or threefold nominal capacity) as they will usually be used intermittently and oversizing would also have to meet the start-up heating requirements. Radiative stoves made of stone, brick or tile are characterized by very long-term heat emission and slow warmup. They should be used for off-peak demand; an additional fast-responsive heater should balance their slow start-up characteristics.

When a heat generating unit is separated from the rooms it is meant to heat, distribution installation should have the shortest possible distance from the boiler or furnace to the habitable rooms. Low temperature fluids requiring larger ducting should be favored. When the distribution system will cross through uninhabitable or sporadically used spaces, the ducts or pipes should be insulated unless the heat losses from those sections could help prevent freezing in those spaces. Exterior walls should generally be excluded from carrying heating ducts or piping.

Heat delivery to the room occurs by convection and/or radiation. Both types are involved to different degrees, depending on the principle and the particular construction of the heat emitters.

Some **convective heating elements** are heat exchangers, some heating up the air flow which rises close to the surface of the emitter element. Then, warm air mixes by natural convection with room air. Surface temperature and constructional characteristics of emitters will determine the velocity of the air current and thus the speed of heating a room up

### Heat Distribution

#### Improvement of efficiency:

- **short distribution of ducts and pipes**
- **insulation of ducts or pipes if necessary**
- **low temperature fluids**
- **avoidance of ducts and pipes in exterior building components**

### Heat Emission

#### Improvement of efficiency:

- **adequate selection of terminal**  
..

# AUXILIARY SPACE CONDITIONING

to the required temperature levels. A portion of the heat from wall-mounted convectors is delivered to the room by radiation. Another type of convective heating is an air heating system which supplies a space with heated air through ducts without radiative fraction at all.

Radiative heating systems emit electro-magnetic waves from a heat source. Striking a surface, the radiation will be absorbed and warm up objects or people, which again will heat the room air. The decisive difference between convective and radiation principles is the pleasant indoor climate produced by large radiating surfaces of walls, floor, ceiling or emitter elements.

Since type and quality of heat emitters influence the quality of indoor climate, the following section describes the most important heating systems and discusses the suitability for passive solar and low energy building designs.

## Radiators and Convectors

Conventional heating systems are commonly equipped with radiators and/or convectors which are usually placed against the exterior wall beneath a window, to counteract the cold air flow from the window. This application is very flexible and the heating output can easily be determined from the manufacturer's instructions. While radiators may be used for low temperature operation, convectors require higher supply temperatures (45°C). A centralized weather-responsive control for the head temperature, emitter thermostats and a delivery-controlled circulation pump are recommended. Emitter thermostats have to be accessible to room air and should be protected from direct sunlight and cold air draughts. Attention has to be paid to the avoidance of any obstructions by curtains, emitter coverings or other furniture which would restrict the adequate response of the thermostat to solar or internally generated heat. Ventilation should be provided for short periods when the valve is turned off. Alternatively, electronic room thermostats or remote control units should be installed for those cases. Emitter thermostats do not provide automatic night setback; they have to be adjusted for lower circulation. However, electronic control units are available that can be linked to the valves, programmable for a 24-hour cycle.

High thermal quality and tightness of glazing also allow the placement of radiators against interior walls without causing thermal discomfort and asymmetric heat flow from the human body. Moreover, an interior location of heat emitters would provide lower installation costs and south-facing windows could reach down to the floor level for direct solar gains.

**Figure 4.16**  
Comparison of different heating systems due to the generated vertical temperature gradients. The dashed graph represents an optimum temperature stratification.

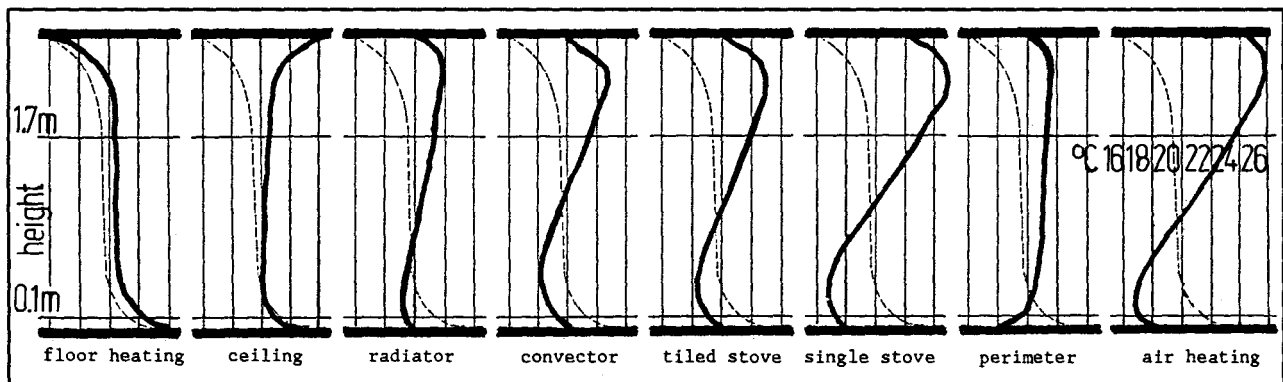

# AUXILIARY SPACE CONDITIONING

## Electric Heating

Electricity is our premium, most versatile form of energy. However, it is often produced very inefficiently from primary fuels (e.g. coal), with highly polluting side effects. Electricity is often very expensive when used for heating, especially at times of peak demand. Where there are alternatives, the use of electricity for non-premium applications such as primary space heating should be avoided. Convective electric heating components provide a clearly defined range of outputs and should not be oversized. Directly operating electrical heaters such as convectors and fans are very fast responding and can easily be controlled room by room. Though they are effective at keeping the room temperature stable, they are insufficient to heat up a cold mass building in an acceptable span of time. The exclusively convective heat emission characteristic should limit their utilization for space heating to the application for peak demand.

Electrical storage heating systems are convective heat emitters as well. However, they use the nocturnal off-peak capacities of the power plants in favor of a better efficiency and of more economical delivery rates. Heat generated and stored through nighttime in an insulated storage mass-block can be delivered during the day by adjustable fan-forced convection. Charging is controlled by weather responsive thermostat, as is the

Heating System	Kind of Heat Emission	Speed of Heat Delivery	Setback of Individual Rooms	Cost % for Heating System <sup>1)</sup>	Cost % for Fuel
hot water centralized heating system radiator or heat transfer plate (90/70°C)	convection <sup>2)</sup>	fast <sup>3)</sup>	by thermostat radiator valve	100 <sup>4)</sup>	100 <sup>4)</sup>
hot water centralized heating system low temperature heat transfer element	convection <sup>2)</sup>	fast <sup>3)</sup>	by thermostat radiator valve	140	90
hot water floor heating system (50/40°C)	radiation	slow	limited by self control effect	150	90
electrical in slab storage heating system	radiation	slow	limited by self control effect	not comparable <sup>5)</sup>	110
electrical storage heating system	convection	fast	by room thermostat	not comparable <sup>5)</sup>	90
centralized air heating system	convection	fast <sup>6)</sup>	by room thermostat	not comparable	90
electrical direct heating system	convection	very fast	by room or emitter thermostat	not comparable <sup>5)</sup>	300
individual heating system (stoves and fireplaces) for solid fuel, fuel, gas	depending on type of stove <sup>7)</sup>	depending <sup>8)</sup>	limited	not comparable <sup>5)</sup>	80 <sup>9)</sup>

Figure 4.17

Criteria of selected heating systems related to passive solar energy use.

### Index:

<sup>1)</sup> including equipment for heat distribution and control - excluding heat generator and fuel stock, i.e., fuel tank

<sup>2)</sup> depending on kind of heat transfer element, i.e.,

- radiators, predominantly by convection
- convectors, only convection
- heat transfer plates close to the wall, more radiation

<sup>3)</sup> plants with circulation pumps

<sup>4)</sup> since this system is very widespread it serves as a reference case

<sup>5)</sup> because the heating system is unified with the heat generator

<sup>6)</sup> for air heating by ventilation

<sup>7)</sup> for example:

- stoves dedicated to fossil fuel with circulation vents, predominantly by convection
- gas heaters, predominantly by convection
- tiled stoves, predominantly by radiation

<sup>8)</sup> simple, mostly older single stoves with limited control - modern stoves have automatic control

<sup>9)</sup> energy benefits because of the limited space use in spite of the worst fuel

## AUXILIARY SPACE CONDITIONING

---

heat level of the emitter unit. This kind of heating can be called a central heating system with an individual controller for each room. Convective heat output can supply the multiple magnitude of the actual heat demand for a short time. From the technical point of view, the positive features of a direct electrical heater and its dynamic operation might make it reasonably compatible with passive solar strategies, assuming ecological considerations are not a factor.

### Single Stoves

Stoves generate heat where it is needed. This includes stoves, operating with wood, coal or miscellaneous solid fuels, as well as those which are driven by gas or fuel oil and supplied by a separate piping from a central tank. Gas stoves are controllable by thermostats. The others are characterized by oversized capacities which deliver sufficient heating for cold periods and immediate increased heat demand - e.g., for start-up heating through reliance on high emitter surface temperatures and higher air convection velocities. The oversizing balances occupant's intermittent operation of the system. Whether this might be an asset or liability for occupants' thermal comfort requirements should be decided in each individual case, as should the constraints of refueling, cleaning, and odor and dust pollution. For solar design concepts, single stoves are likely to serve as an auxiliary heating system for extremely cold periods and/or in combination with open fireplaces for amenity reasons.

### Hot Air Heating and HVAC Systems

Forced air heating systems are special models of convective systems. Room air is mixed directly with the delivered hot air, without heat exchange of indoor air with an emitter surface. Since the specific heat capacity of air is only  $0.32 \text{ W/m}^3\text{K}$ , the efficiency of air heating systems depends on the temperature and the volume of the supply air. Thus, adequate volumes of air can only be transferred by large supply ducts or high temperature levels, respectively. For comfort reasons the supply air temperature should not exceed  $50^\circ\text{C}$ , and the air charge of a room depends on the kind of operation mode, whether circulation air exclusively or fresh air supply system. Centralized air heating systems may also allow unpleasant noise transmission when rooms are connected to a collective circuit of supply and/or exhaust air. Generally, the system's suitability for passive solar designs is perfect, as it can be directly linked to solar heated air flows (convective gains) and is fast-responsive to direct gain systems as well. Forced-air systems merit extra consideration in those climates that require heating and cooling for most of the year. Moreover, regional and/or local traditions influence or even define the popularity, distribution and availability of the system. Forced-air systems are scarcely used in middle European countries since they cannot replace existing heating systems in buildings. Even for low energy buildings (heat losses  $< 1 \text{ W/m}^2 \text{ K}$ ) an exclusively fresh air operation mode could not eliminate the need for an auxiliary heating system.

Conversely, in the United States, these systems are commonplace and widely available, even for small residences. Aside from cost, the choice of a forced-air system is based upon the degree of control capability and the required flexibility, environmental influences, energy consumption and efficiency. There are different systems available characterized by different fuels (electric, oil, natural gas, liquid gas), and by different needs; furnaces provide heating only, while heat pumps meet heating or cooling needs through the same duct work.

## AUXILIARY SPACE CONDITIONING

---

The following section discusses very briefly a selection of potential HVAC system configurations rarely used in residential buildings.

Selection of HVAC Systems

A **single duct, single-zone system** is a wall-mounted all-air system for spaces which need only one temperature control zone of uniformly distributed heat. Since a single conditioner **serves** only one zone, the system applies only to very small buildings. A special concern is the avoidance of simultaneous heating and cooling operation and the maintenance of filters to reduce airflow resistance.

A modification of this system is the **terminal reheat system** which supplies several zones by cooling down the supply air to the temperature levels required in the coolest zone, and subsequently reheating the air for other zones. System control for smaller multi-zoned buildings is excellent; however, the supply air volume should be reduced and the system should run only on temperature demand cycle. If a sufficient heat source is not available the energy waste is considerable, especially if constant volume is maintained.

**Dual-duct systems** condition all the air centrally which will then be distributed through two parallel ducts (cold air and warm air duct) into the spaces. Since heating and cooling must be available at all times, the system is used only for non-residential buildings with multiple zones that require highly variable heating and cooling loads. Small and medium-size buildings with two or more individual zones may refer to constant-volume multizone systems that mix hot and cold air at a central air conditioner, according to the individual requirements of each zone by thermostats. All intermediate zones are supplied with a mixture of cold and warm air using energy in away similar to the terminal reheat system. Individual heating and cooling coils for each zone can reduce energy consumption drastically.

**Constant-volume induction systems** are applicable for buildings with two or more individual zones. Terminal units recirculate return air from interior spaces and, in commercial buildings, from lighting fixtures. These terminal units are thus able both to take advantage of available internal heat and to reduce the volume of primary supply air needed for space conditioning.

Buildings with minimal interior spaces may use **all-water systems** which use fan coils or unit ventilators with unconditioned ventilation air supplied by an opening through the wall or by infiltration. Cooling and dehumidification are provided by circulating chilled water or brine through a finned coil in the unit. Heating is provided by supplying hot water through the same or a separate coil, using two-, three-, or four-pipe water distribution from central equipment. Electric heating at the terminal can be used to enhance system flexibility.

# AUXILIARY SPACE CONDITIONING

## Radiant System

Radiant heating systems provide a higher radiant fraction of heat transfer. As opposed to convective systems, the surface temperatures of emitters are lower (40 - 60°C) and thus the emitters have to be larger to meet comparable efficiencies; this extra space demand has to be considered in advance. The lower operating temperatures result in different advantages: the heat losses of the distribution system will be reduced and the capability of control and adaptability increase. More-over, the lower temperatures improve indoor climate conditions.

## Floor heating

The classic radiative heating system is the water-type floor heating system; it supplies even heat distribution to the space. One common system is characterized by in-slab heater pipes and a low temperature of nearly 40°C. Thus, the system is perfectly compatible with heat pumps and / or active solar systems. On the other hand, the system has a big time lag between the call for heat and the time of heat delivery. Changes in outdoor temperature are signaled by weather-responsive controls; it takes several hours until a change of room air temperature occurs. Thus, floor heating systems of high storage capacities have to be matched with the proper controls.

The system is a good choice for conventional mass building. For passive solar low energy buildings, however, the big time lag is disadvantageous for spaces heated by the sun. For direct gain concepts, for instance, the heat level of the floor would decrease solar heat storage capability and thus promote overheating of the room. In fact, there is a slight balancing counterweight effect from the energy efficiency point of view: as the heat

Figure 4.18  
Air temperature distribution of different heat emitters.

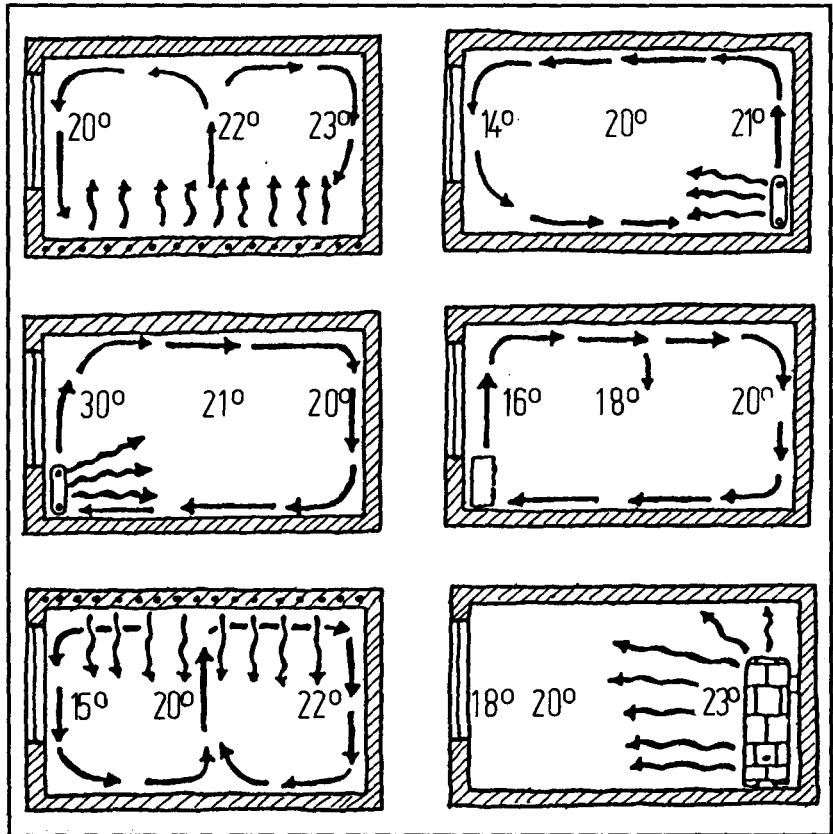

Figure 4.19  
Surface temperatures and storage capacities (kWh) of different heat emitters.

heat emitters and surface temperature	storage capacity (kWh)
elect. heater 80 °C	0.01
fireplace 70 °C	0.20
convector 50 °C	0.30
low temperature panel radiator 40 °C	0.50
laminated flat	2.00
floor heating 30 °C	5-13.00
tiled stove 150 °C	8.00

## AUXILIARY SPACE CONDITIONING

of the emitting surface (26°C) is influenced by the temperature difference against room air (20°C), an increase up to 21°C would reduce the temperature difference from 6 degrees to 5 degrees, which is also corresponding to a reduction of heat capacity by 1/6, i.e., about 17%.

Ceramic tiles are best for covering floor heated surfaces, as this material provides high conductance for heat transfer from the in-slab coils to the emitting surface. Nevertheless, other coverings such as PVC, thin parquet floor and carpets can be used when they are uniformly pasted onto the concrete floor. However, the heat emitting output will slightly decrease when the physical properties of the covering material reduces the heat transfer. On the other hand, the surface temperature sensation will be more comfortable when the heating system is not in operation. The characteristics and the evaluation of electrical floor heating systems are similar to those of the water-type system, disregarding the questionable use of electrical energy for heating purposes.

### Tiled stoves

A tiled stove is traditionally a fossil fuel fired heating system made out of fire-brick and fire-tiles which may reach surface temperatures of 100-150°C. The stoves are very big and usually oversized in capacity to account for the intermittent firing routines (once or twice per day).

In spite of the high surface temperature, the large tiled emitter areas retard convective heat transfer and thus the dust circulation of room air in favor of radiant emission from the fire-bricks. Fire-clay has a large storage capacity and the capillary structure slows down the heat conduction to the surface. The stove is generally located on interior walls, heats the wall surfaces by radiant heat emission (figures 4.18 - 4.20). Thus, the air temperature can lower (17-18°C) while still providing thermal comfort (refer to section 4.1 Thermal Comfort).

Occupants' judgement of the radiant indoor climate produced by the tiled stove is generally positive. It creates different heat sensation, depending on the distance to the emitter surface. The big tiled stove's thermal lag does not allow a fast response to solar or internally generated heat. Thus, this heating system should not exclusively be used for passive solar designs. However, the tiled stove can be used if:

- the floor plan is carefully zoned into solar and nonsolar areas
- a hot air or water charge could take over the fast-response requirements of solar supplied areas (central system)
- the tiled stove serves for off-peak demand
- the system will be fired based on weather forecast
- big rooms create different areas providing different thermal requirements

A radiant indoor climate can also be created by a smaller increase of surface temperatures of larger building components (improvement of mean radiant temperature). The most representative example of early designs is the Roman hypocaust heating system: heated air circulated through the cavity of the floor and/or walls exposed to the room to increase the surface temperature. Modern designs rely on hollow block construction and vented building components such as floors, walls, and

**Figure 4.20**  
Basic construction of a heavy mass tiled stove

**Figure 4.21**  
Modern hypocaust heating system by warm air through floor and wall cavity (double envelope principle)

**Figure 4.22**  
Wall radiant heating system by hot water heating coils

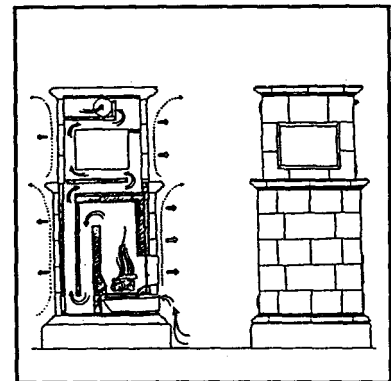

**Figure 4.20**

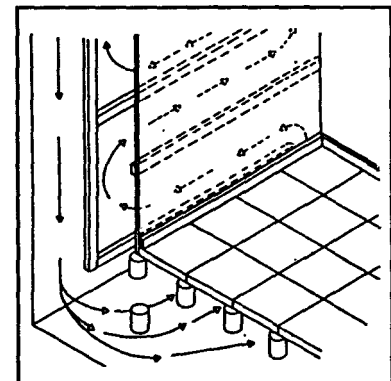

**Figure 4.21**

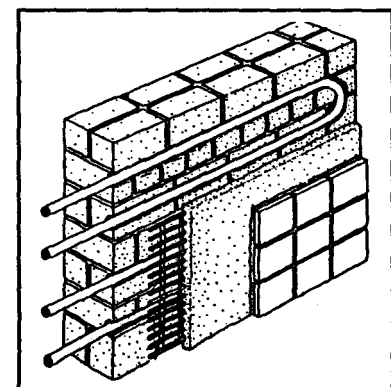

**Figure 4.22**

# AUXILIARY SPACE CONDITIONING

Figure 4.23-4.26

Different principles of baseboard heating systems attached to or integrated into the wall. The wall radiant heating effect is caused by the "coanda" effect of rising warm air.

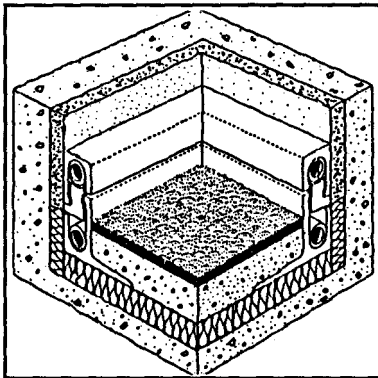

Figure 4.23

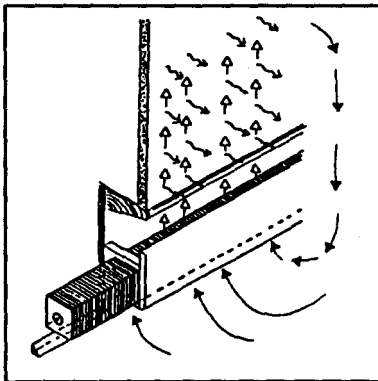

Figure 4.24

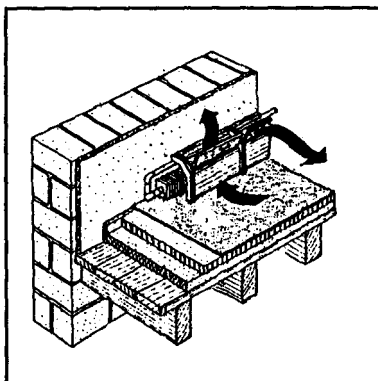

Figure 4.25

ceilings. This approach has multiple advantages for both thermal comfort and energy efficiency of passive/hybrid solar gains.

## Double envelope concept

The double envelope concept is a hot air heating system disconnected from room air. Heated air will be blown into the cavity between a highly insulated wall and a panel exposed to the room (figure 4.21). The heat is generated by a central boiler, heat exchanger, or air conditioner and can be combined with solar convective gain systems. The inside wall layer should preferably be made of gypsum panels or, like the floor covering, out of timber. The reduced storage capacity (compared with a mass brick wall) unifies radiant indoor climate and results in a faster responsiveness to solar gains. The suitability is excellent for single-zone buildings since multizone configurations are sufficiently complex that they should be individually controlled as HVAC systems.

## Wall radiant heating systems

This system is the floor heating principle turned perpendicular to the ground and integrated into the wall (figures 4.22). Depending on the system type, the heating coils are put into the cement joints of a masonry wall with exterior insulation. The coils are made of copper or, in other systems, out of polyethylene which are only 2-3 mm in diameter and come in dense capillary mats onto the wall. The wall finish is a layer of plaster with/without a plastic reinforcement. The advantages of large radiant wall heating systems are:

- positive effect upon the mean radiant temperature
- simultaneously dispense with heat emitters and increase solar gains by room-high south glazing
- faster response of the heating system to free heat because of the thin layer of plaster
- low head temperature of water supply (40°C) which could also be supplied by and/or combined with heat pump and/or active solar systems
- entire storage capacity of the floor space can be used for direct solar gains
- costs are comparable to those of conventional heat emitters
- troublefree utilization for retrofit, as the capillary mats can be put directly onto the wall and can be plastered by a second layer (depending on the quality of the existing wall surface)

In comparison to the advantages of the system, disadvantages can be solved if the system is considered early in the design process:

- The relatively low heat capacities per square meter of the system require larger heat emitting areas and should not be restricted by furniture placement. Agreement with the occupant is necessary.
- Wall fastenings have to be set very carefully to avoid damage of the capillary piping (check by scratching the thin layer of plaster).
- Mass of walls cannot be used for direct solar



### Baseboard heating system

At first sight, this type of combined convective/radiant heating (figures 4.23 - 4.26) seems to be a conventional system: small laminated aluminium convectors supplied by copper piping are placed close to the wall and to the floor. The radiant component of this baseboard convective heater is based on the so-called "Coanda"-effect: the rising warm air current close to the wall will transfer its heat content to the wall, increasing the surface temperature and creating a mild interior radiant climate with low temperature gradients.

Further advantages are:

- As there is only a thin layer of wall to be heated, the system inertia is very low. Thus, the concept is suitable for spaces of sporadic use or as a complementary concept with slower radiant heating systems.
- Good compatibility with solar gain systems (see advantages of wall radiant heating systems).
- Cost is comparable to conventional heating systems.

Special consideration has to be paid to the placement of furniture when the calculated heat capacities of the system require the entire space of baseboards. Maintenance of the lamellas is necessary.

### Convective heated wall

Some baseboard system disadvantages are eliminated when the convector is integrated behind a wall panel, providing a hot air circulation cavity to the wall. The panel material could be gypsum or timber and the wall also has to be insulated from the outside.

A modification of this type is the placement of the convector into a wall recess underneath the interior panel of the wall to make the heater more accessible. Moreover, additional air flaps may provide a second operation mode: convective heating will occur when the flaps are turned to the space, directing the heated air into the room. This mode can offset the somewhat slower response rate for start-up heating requirements when the space will be used sporadically.

There are two different kinds of heating operations to be distinguished related to supply and demand of heat. The demand-related heating system will run only in the case of a real heat demand, while the automatic supply-related heating operation emphasizes night setback. The essential interdependencies of building/heating system and passive solar systems have been discussed in chapter 3.

As also previously mentioned, the most important heating system precondition for making full use of available solar energy is the ability of the system to react very quickly upon temperature variations caused by solar irradiation. This responsiveness directly depends on automated controls. Exclusively centralized control systems (i.e., with reference to ambient weather conditions) cannot respond to solar gains in south-facing rooms, as the temperature level has to be adjusted at the central heating unit (i.e., in the basement) with regard to non-solar located rooms. Overheating the solar gain room would be the consequence and thermal comfort would require wasteful ventilation of heat. Thus, for conventional water central heating systems, energy-saving and profits from solar gain can only be achieved by single-room controls, i.e., emitter thermostats or central room units which are interconnected to the central system control.

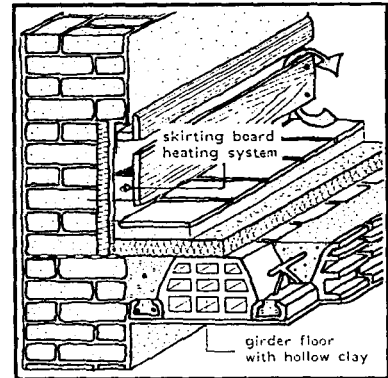

Figure 4.26

### System Control

Improvement of efficiency:

- centralized controls referring to ambient temperature
- central unit for each room
- placement of unit at a thermally representative location of room
- accuracy and low response time

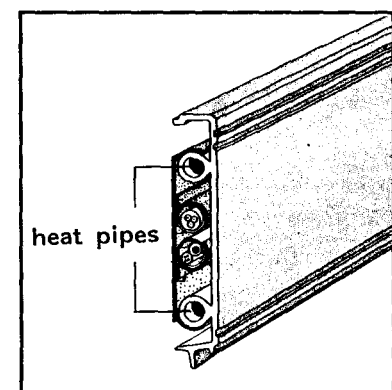

Figure 4.27

# AUXILIARY SPACE CONDITIONING

## Heat Pump Systems

Heat pumps use both electricity and environmental heat sources for space heating and/or cooling. The principle is similar to a refrigeration machine: for cooling purposes heat is extracted at a low temperature, and for heating purposes heat is rejected at a higher temperature level. Depending on the heat source, the system works less efficiently during cold snaps. Thus, the evaluation of systems efficiency (coefficient of performance) has to consider the local and temporal heat source condition related to its useful temperature range. Monovalent heat pump systems should only be used when the reliability of the heat source (soil, solar heated water, ground water, waste heat) is guaranteed for all the time of demand. Heat sources such as ambient air, radiation and waters are characterized by high periodic variations of their capacities and should use bivalent system operations to balance supply problems.

Examples of those system configurations are:

- air/air heat pump (heat source is ambient or exhaust air) and fuel oil furnace
- air/water heat pump for peak demand (for floor heating system) and fuel oil or gas furnace
- water/water heat pump (heat source is ground water) for low temperature radiant heating system plus multi-fuel combustion boiler as back-up system

The application of a heat pump is most economic if the delivery temperature of the heating system is as low as possible, i.e., low temperature radiant heating systems, or the temperature level of the supply medium

**Figure 4.28**  
Determinants of heat pump concepts depending on source energy.

heat source	Availability		temperature range of thermal medium (°C)	Design of Heat Pump			Costs		requirements upon building design
	local	temporal		operation	operation temperature (°C)	accessible working coefficient COP	design costs	operating costs	
air	good	good	+15/-12	bivalent	<50	2,2	moderate	high	partly necessary
radiation	good (space demand)	moderate	+15/-12	bivalent	<50	2,2	high	high	partly necessary
storage ground	moderate	good	+10/-5	mono or bivalent	<50 <50	2,7	moderate	moderate	only building site
soil	rare	good	+10/-5	mono or bivalent	<50 <50	2,7	high	moderate	only building site
ground water	rare	excellent	+12/+8	mono or bivalent	<50	2,9	high	low	only building site
waters	rare	good	+15/0	bivalent	<50	2,7	moderate	moderate	only building site
waste heat	rare	good	>15	mono or bivalent	<50	>3	moderate	moderate	partly necessary

## AUXILIARY SPACE CONDITIONING

(heat source) is as high as possible. Also, the heat pump consumes electricity during the compressor operation. Depending on the source energy, there are different design solutions with a variety of system outputs (see figure 4.15 on page 104). For small residential buildings, the common system will be power driven small units for air handling systems (5-10 kW) and middle-sized water driven plants (5-50 kW).

Heat pump systems may be designed with or without a buffer storage tank. Systems without a storage, usually small air/water units, should be designed for heating systems of slow response heat emission (floor heating, wall heating) to avoid numerous on and off cycles. For larger units, and if slow-response emission systems are not practical, a buffer storage should be installed which increases the operating hours and thus the life span of the plant.

Gas driven absorption heat pumps are reasonable for capacities of 20-80 kW. The gas motor heat pump is very expensive to install and operate and should not be used for capacities below 250 kW. Recent developments of diesel-driven motive heat pumps allow the application of smaller units (25 kW). Aside from mechanical energy of the combustion motor, the heat of the cooling circuit and from the exhaust gas in motive systems.

Active solar energy use is dependent on solar irradiation intensities during the heating period. Either air or a liquid (water and anti-freeze) can be used to collect solar heat. The components necessary for a basic solar collector system are the collector (liquid or air heating type), an insulated storage tank and associated pumps (or fans), piping (or ducting), auxiliary heater and a control system. Space heating and domestic hot water heating are the common system applications. Both types have different features (see figure 4.28) and should be selected and sized according to the particular application, whether they are intended for space heating and/or DHW. General recommendations for sizing the system are:

- Collector tilt for space heating is approximately the latitude plus 15 degrees; for domestic hot water only the optimum angle is about the latitude angle, and depending on the requirements, probably less.
- Space heating requires knowledge of the building heat losses of the worst case in winter and the corresponding average solar irradiation to the collector area
- For DHW systems, the sizing the collector area depends on the hot water demand, which also determines the size of the storage tank.
- For overall system efficiency, the construction of the collector/absorber is most important. Depending on the quality of glazing, selectivity, and shape (flat, tube, concentrating), various collector efficiencies can be achieved, usually available from the manufacturer.
- Collector efficiencies will influence the size of the collector area, and could also have an architectural as well as an initial cost impact.
- To achieve 100% (theoretical example) solar contribution for space heating the collector area should be sized according to the formula

$$a = \frac{\text{heat loss (kWh)}}{\text{insolation (kWh/m}^2\text{)} \times \text{efficiency (\%)}}$$

- Heat loss and insolation relate to the worst month, and sizing down the collector area will give the desired solar contribution.

## 4.5 Active Solar Systems

Figure 4.29  
Active solar system configuration.

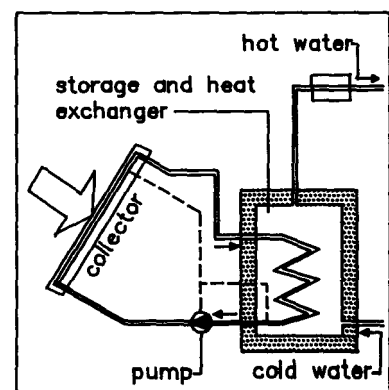

# AUXILIARY SPACE CONDITIONING

---

For climates that require heating for most of the year and which have only moderate sunshine, only small systems can be cost efficient (predominantly for DHW). The solar heat has to be exchanged into a storage which is connected with the back-up system. The storage should be tall to provide for temperature stratification. Water is taken from the lowest part of the tank, is solar heated, and is then returned to the top of tank. If more winter sun is available, a middle-sized system combination for space heating and DHW may be cost-effective.

## Characteristics of Liquid and Air Collector Systems:

### Liquid Systems

- Collectors are generally more efficient.
- Combination with domestic hot water and air cooling system possible.
- Antifreeze and heat exchanger are often preferred, which causes reduced efficiency and higher costs.
- Precautions have to be taken against corrosion, leakage, and boiling.
- Insulated pipes require nominal space demand and are more convenient to install in existing buildings.
- Higher installation costs for collectors and storage components.
- Have received greater attention from solar industry, and thus a greater variety of systems and components are commercially available.

### Air Systems

- Collectors generally operate at slightly lower temperatures.
- Simpler in system construction; space heat can be supplied directly or domestic hot water can be pre-heated. Difficult for adaption to air coding.
- Freeze protection is not necessary. Acoustical problems may arise when spaces are interconnected by ducting.
- Low maintenance requirements. Small leaks can easily be repaired with duct tape.
- Ductwork and storage (rock bed, ventilated hollow mass constructions) need early design integration.
- Lower equipment costs.
- Higher energy consumption for fan operation than for pumps. Fans are noisier in operation (depending on placement and system sizing).

Occupant behaviour and needs directly influence and determine energy demand, consumption and waste. Since it is necessary to get a more or less rough estimation of the future user, whether known or unknown, basic factors and kinds of user behaviour will be discussed in this section.

A family's decision to incorporate passive solar features in this new home might lead one to assume that the family understands that the way they operate the home will have a major impact on their home's energy consumption and comfort. The designer must make sure that the family indeed has such an understanding.

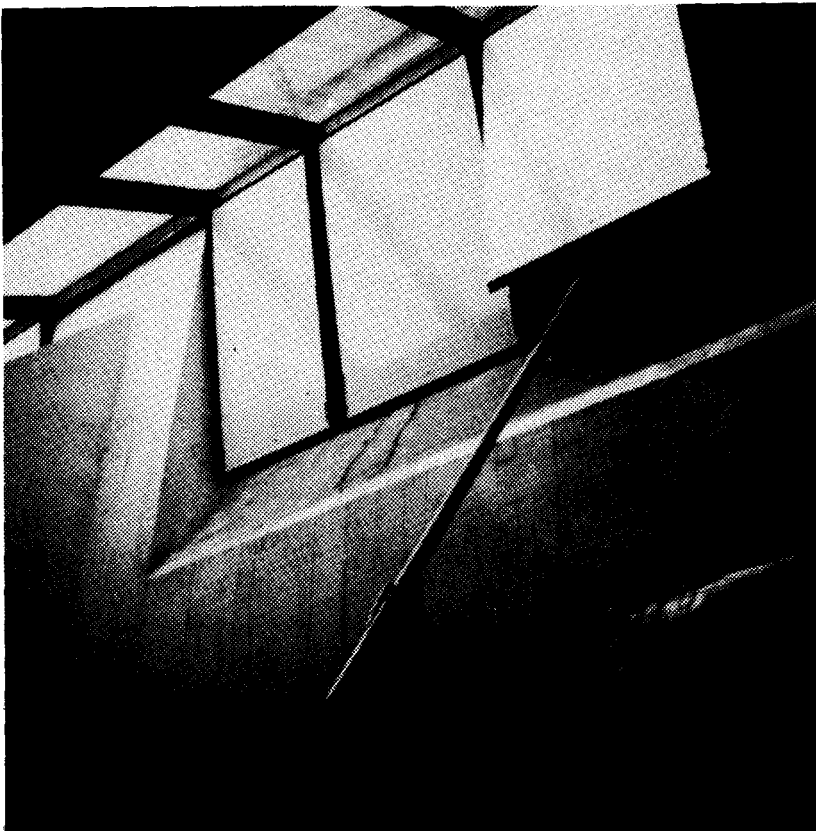

*Figure 5.0*  
Movable insulation of clerestories in the  
Arditi-Bloch solar residence in South  
France.

Design: M. Gerber, Fitou, France

# USER INFLUENCE

---

## Checklist

### User Analysis

- Building purpose and space use program define its energy use and demands. Find out as much as possible about future occupants.
- If the user is individually known (client, owner), investigate user's
  - attitude to energy problems
  - present practices concerning energy consumption and savings
  - knowledge about passive-hybrid solar systems, probably own experience
  - motivation and interest in solar system usage
  - economic conditions
  - lifestyle and pattern of space use

### Occupant Information

- If the user / occupant is unknown, make assumptions on user's behaviour: consider a wide range of factors and select simple but comfortable operating systems.
- Consider the solar myths, sometimes deep-rooted in user's mind; do not underestimate your influence on user's habits - but also do not overestimate user's readiness of acceptance.
- Give advice and information to the user about:
  - his potential influence on energy balance and system efficiency
  - dynamics of system control
  - space use variations
- consequences of living behaviour on energy consumption and thermal comfort
  - demands on system operation and maintenance.
- An extra effort should be made to clear up the actual expected use of a sunspace to avoid extra costs and construction failures. Under-standing intended sunspace use is the most crucial factor to guarantee successful system performance.

### System Acceptance

- Check the intended passive - hybrid system for:
  - ease of understanding
  - ease of operation
  - security of performance
  - ease of maintenance
  - robustness
  - economics
  - comfort
  - performance/energy savings
  - durability/reliability

# USER INFLUENCE

Unlike unoccupied research buildings used to evaluate low energy and passive-hybrid solar systems and components, the "real-world" conditions of occupied residences are more than a sophisticated applied research level. Investigations of user behaviour in the past have shown that even identical residences may cause many-fold variations of energy consumption. In many cases the lack of information about the "philosophy" of the building or mishandling of certain components produced energy inefficiencies. Since heating systems, in concert with passive solar strategies, can be complex to operate, the potential benefits of low energy consumption could be lost by improper utilization. In low energy passive solar homes, the occupant plays an important role concerning energy demand, consumption and savings. The fundamental discussion about the user's acceptance is characterized by the question of his responsibility for passive system operation and maintenance. There are opposite opinions: some voices claim that high tech automation and control will guarantee system performance according to ambient climate conditions. Others call for occupant consciousness and willingness to play a responsible and decisive role in controlling energy gains and losses. The "truth" will lie somewhere in between and should be decided individually. The user should understand the energetic correlations and components of the building; this is an essential condition. On the other hand, the user should not become the slave of his own home. The figure below shows the variety of interdependencies on the efficiency of passive solar systems and the factors of influences which are controlled by the user. His behaviour and comfort requirements determine the building energy efficiency, which is the result of interactions between heat gains and heat losses.

## 5.1 User's Impact on Energy Performance

Figure 5.1  
Variety of interdependencies on the efficiency of passive solar systems and the factors or influences which are controlled by the user.

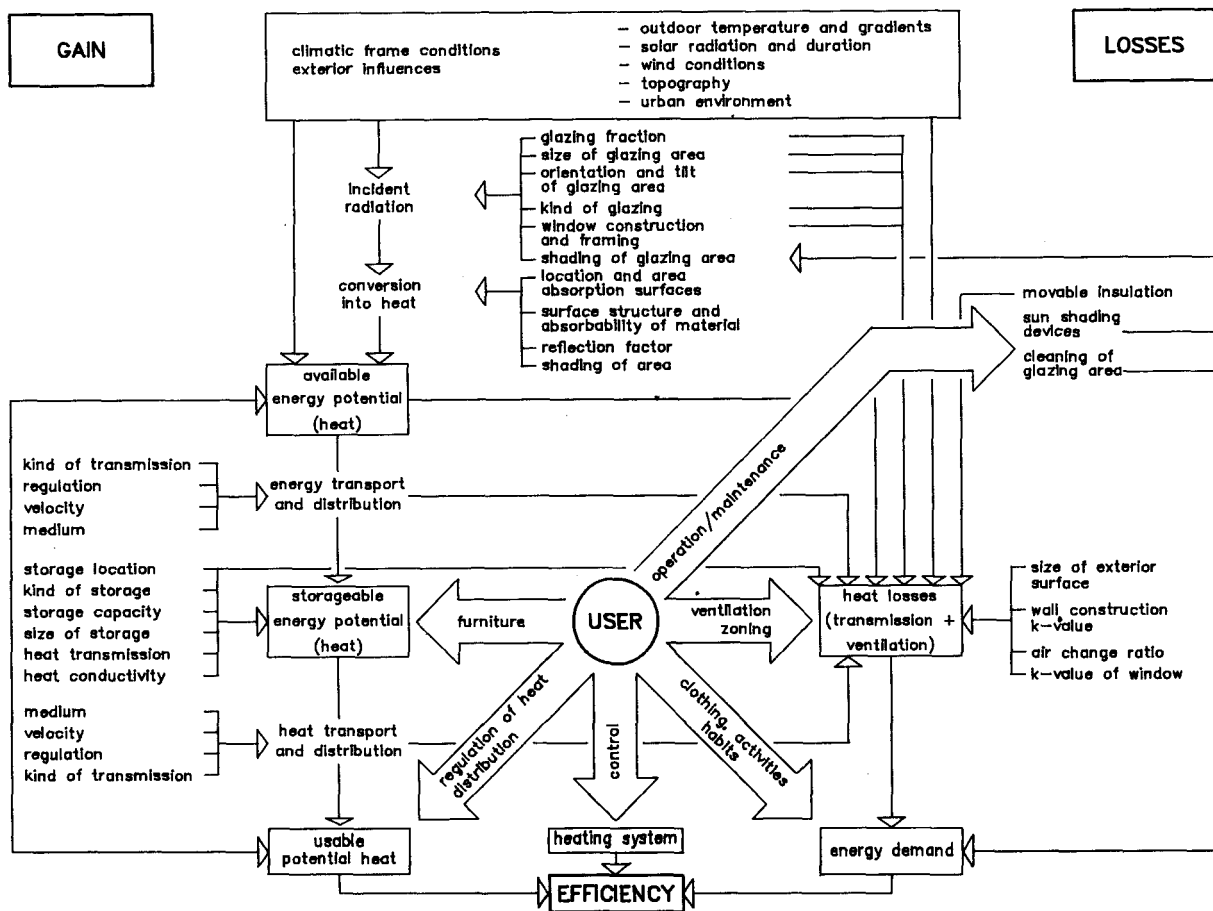

# USER INFLUENCE

## 5.2 Determinants of User's Acceptance

Energy consumption is influenced by several factors. On the one hand, these factors constitute the context under which the user acts, and on the other hand, they are personal factors of the user himself.

<b>personal determinants</b>	<b>affective factors</b> <ul style="list-style-type: none"> <li>- sensitivity</li> <li>- attitude</li> <li>- motivation</li> <li>- habits</li> <li>- behaviour</li> </ul>	<b>cognitive factors</b> <ul style="list-style-type: none"> <li>- realization</li> <li>- information</li> <li>- knowledge</li> <li>- experience</li> <li>- attitude</li> </ul>
<b>economical determinants</b>	<b>individual conditions</b> <ul style="list-style-type: none"> <li>- ownership (owner or tenant)</li> <li>- income</li> <li>- savings</li> <li>- situation of employment</li> </ul>	<b>general conditions</b> <ul style="list-style-type: none"> <li>- economic situation</li> <li>- programs of subsidy and advancement (promotion)</li> <li>- remission of taxes</li> <li>- costs of energy, building and appliances</li> </ul>
<b>social determinants</b>	<b>social-demographical factors</b> <ul style="list-style-type: none"> <li>- social class membership- (income, education, profession)</li> <li>- size of household</li> <li>- living area (city, country, size of town)</li> <li>- age of the head of the household: youth 18 - 26 middle aged 27 - 60 elderly above 60</li> <li>- life cycle (periodic absence, daily routines)</li> <li>- position in profession</li> </ul>	<b>social-environmental factors</b> <ul style="list-style-type: none"> <li>- neighborhood, friendship acquaintance</li> <li>- environmental regulations, cultural environment</li> <li>- general lifestyle, hobbies</li> <li>- general condition of housing environment</li> <li>- participation, memberships</li> </ul>
<b>building related determinants</b>	<b>technical</b> <ul style="list-style-type: none"> <li>- heating system (kind, disposition, efficiency, peak)</li> <li>- domestic water heating</li> <li>- layout of electrical equipment</li> <li>- illumination</li> <li>- infra-structure (duct systems, distribution structure)</li> <li>- alternative equipment (technologies, systems, etc.)</li> </ul>	<b>architectural conditions</b> <ul style="list-style-type: none"> <li>- disposition of building</li> <li>- regional, local, micro-climatic relationship</li> <li>- level and physical properties of insulation</li> <li>- kind and condition of windows</li> <li>- peculiarity of building/flat (sunspace, exceptional design of facade, etc.)</li> </ul>
<b>institutional determinants</b>	<b>legal</b> <ul style="list-style-type: none"> <li>- legal status of user (owner, tenant etc.)</li> <li>- right of tenant</li> <li>- legal premises of energy supply (i.e., energy saving regulations, regulations of energy cost)</li> <li>- legal premise of building and housing</li> <li>- regulations concerning technical appliance</li> <li>- law of user's protection, law of environmental protection</li> </ul>	<b>organizational factors</b> <ul style="list-style-type: none"> <li>- clearing of energy costs</li> <li>- energy supply utilities (private, public)</li> <li>- tenant/lessor-situations (i.e., co-operative society, hiring of single houses)</li> <li>- co-operative activities/projects (i.e., heat pumps, solar systems)</li> </ul>



# USER INFLUENCE

While personal determinants directly influence the choice and performance of energy systems in the house, social, economic, technical, and institutional factors will indirectly influence overall building energy performance.

Examples:

- The consumer of electricity or distant waste heat has almost no influence on supply systems;
- The tenant of an apartment has smaller influence on kinds of heating systems or means of insulation;
- The consumer's range of action is greater - even as a tenant - concerning kinds of ventilation, temperature-setting or purchase of household appliances; here, influence on energy consumption is possible.

Daily energy consumption is mainly an unconscious action. Settled habits, attitudes and behaviour have developed. They are rarely questioned and can prevent change of behaviour as much as building related or legal and institutional conditions.

Conscious consumer behaviour starts, when the consumer develops distinct criteria for his using, buying and creating behaviour. These are - for example - housing comfort, energy saving, minimizing of energy bills or minimizing of initial costs.

Using behavior determines how the occupant interacts with energy consuming facilities and systems as well as the requirements of energy consuming services.

Examples:

- Night thermostat setback of heating system.
- Setpoint of room temperature for individual rooms at different times and under different conditions (presence and absence of people, time of the year, holidays, etc.).
- Usage of household appliances (washing machine, dishwasher, kitchen stove, etc.).
- Cooking and baking habits.
- Usage of domestic water for shower, bath, washing and cleaning.
- Usage of household appliances (washing machine, dishwasher, kitchen stove, etc.).
- Use, care and service of heating systems and air-conditioning, kitchen oven, car, and so on.
- Ventilation behaviour.
- Handling of shading devices.

These examples demonstrate that using behavior is determined by the way, the frequency, and the degree of the use of energy consuming facilities, systems, and services. It is a reasonable assumption that the simplest way to save energy is a dynamic heating behaviour based on the individual diurnal requirements of users. Depending on the occupancy patterns (figure 5.3) in terms of number of people, temporal use, and occupancy variations of closely adjoining units, however, the hypothetical energy saving potential (see figure 5.2) is limited. Designer

## USING BEHAVIOR

**Figure 5.2**  
Idealized comparison of constant and intermittent heating mode, without regard to inertia of building and heating system: hypothetically, an energy saving of 75% can be achieved when heating operation is limited to the actual presence of occupants.

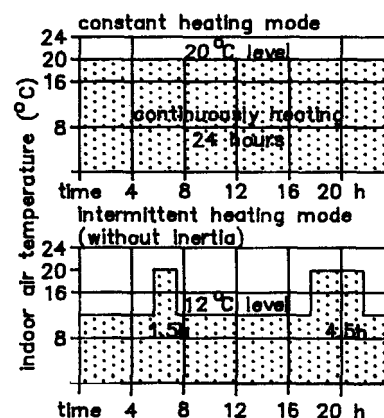

# USER INFLUENCE

and occupants should become knowledgeable about the impact of living and heating habits on total energy consumption and on comfort levels. Therefore, user education and information on what the building and the heating strategy are like should be provided by the designer, to eliminate widespread prejudices concerning passive solar homes.

Prospective occupants who have never lived in a passive solar house may have unintentional doubts from inexperience and from the fear of supposed restrictions on their traditional life-style such as :

- alterations in the way occupants are used to living
- expected cooler temperatures and warmer clothing habits
- more extreme variations in temperature gradients
- an increase in effort to maintain their home and systems
- expectations of damages to furniture, wall and floor covering
- higher initial, running, and maintenance costs

Designers have to be aware of the myths expressed in these doubts and cares, and should try to dispel them with sound information and consultation. Designers should also realize that people tend to be more and more receptive to solar energy; this chance should not be wasted. Thus, prospective clients and occupants can only be encouraged by reasonable passive solar design strategies which are either proven enough to guarantee energy benefits and/or which convince by an increase of living quality expected by the occupant.

**Figure 5.3**  
Diurnal frequency of space use by household members (after studies from Meyer - Ehlers, F.R.G.).

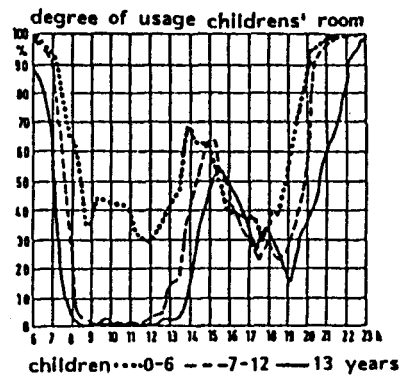
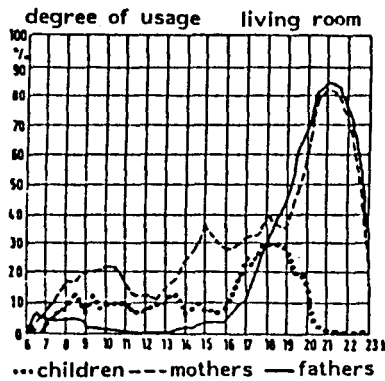
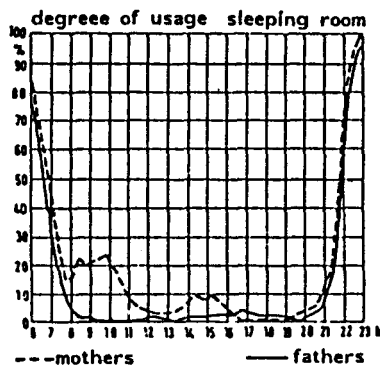

ROOM	Ventilation rate per hour		recommended indoor air temperature °C	desired adjustable range °C
	min	desired		
bathroom	4	5-8	22	20-23
living room	0.5	2-3	20	20-21
dining area			19	18-20
children room				
study	0.5	2-4	19	19-21
children - playing			18	18-20
working kitchen				
kitchen 20 m <sup>2</sup>	10	20-30	18	17-19
kitchen 20 -30 m <sup>2</sup>	8	10-25	18	17-19
kitchen 30 m <sup>2</sup>	6	10-20	18	17-19
sleeping room			18	17-19
(sleeping, crafts)	0.5	2-3	17	17-20
WC, toilet	2	4-6	16	16-18
entrance hall			15	15-16
porch			15	14-16
stair case, corridor	1	2	14	

# USER INFLUENCE

The purchase of energy consuming equipment, systems and services is part of the total consuming behaviour and may lead to low or high energy consumption.

## BUYING BEHAVIOR

Examples:

- Decision for buying a house and not buying an apartment / flat can result in a twofold increase in the consumption of heating energy.
- Purchase of a dishwasher may double energy consumption compared to manual dish cleaning.
- Buying a new heating system may lower energy consumption by 25-50 %.
- Buying an energy efficient refrigerator rather than a conventional refrigerator can save 30% of energy costs.

Creating behaviour is defined as the conscious influence of the consumer on determinants of energy consumption.

The consumer has a wide range of creation in energy consumption behaviour concerning choice of mechanical equipment and modification of building conditions, use of personal and economic possibilities (property, ownership, discount of taxes, subsidies), and influence on social environment and on institutional realities.

## CREATING BEHAVIOR

Examples:

- Reduction of heating energy by means of insulation.
- Improvement of window area by replacement of single glazing with double or multiple glazing, means of joint sealing and movable insulation devices.
- Installation of solar systems to substitute for fossil energy sources.
- Modification of floor plan by changing the functional arrangement of rooms.
- Development of buffer zones and/or sunspace for reduction of energy losses, gain of solar energy as well as improvement of living quality.
- Improvement of mechanical systems for increasing system efficiency.

All three categories of consumer behavior (using, buying and creating behaviour) may result in increased energy use, average energy consumption or reduced energy consumption. It is the designer's task to develop an optimal strategy of action of reasonable energy use for each individual situation. Here the specific interests and consuming conditions of the user should be considered. An optimal combination of altered behaviour in using, buying and creating of energy consuming facilities, systems and services should be intended.

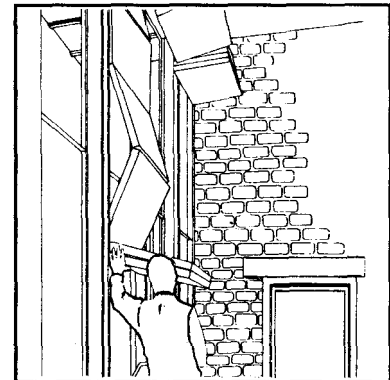

Figure 5.5

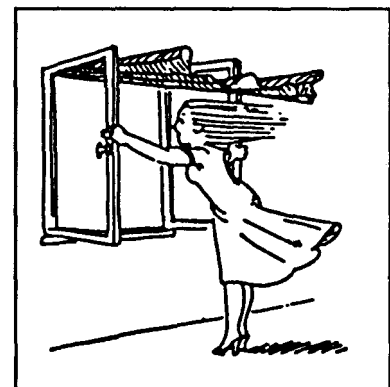

Figure 5.6

# USER INFLUENCE

## 5.3 User's Acceptance of Certain Systems and Components

Passive solar designs are meant to achieve a high living quality at a lower energy cost, both to the occupants themselves and to the society of which they are a part. For this reason alone, passive homes are different from conventional residences and even from other kinds of low energy homes because of the methods used to pursue energy efficiency in them. A passive solar house is a dwelling in which positive steps have been taken by its designers to maximize the use of solar energy. Sophisticated integration of bioclimatic influences and adequate disposition of solar energy collection, storage, and distribution of building design and auxiliary space conditioning are the primary characteristics of passive solar design.

Figure 5.7  
Energy - related aspects of passive solar system performance and corresponding consequences for design and user.

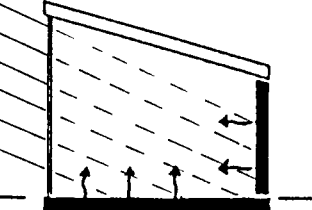
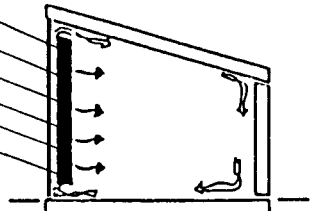
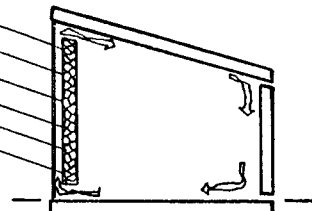
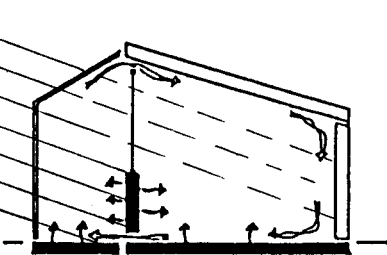
PASSIVE SYSTEM	System Aspects	Consequences for Design and User
<p><b>Direct Gain</b></p> 	<ul style="list-style-type: none"> <li>- sun protection</li> <li>- glare protection</li> <li>- movable insulation</li> <li>- storage location</li> <li>- storage material</li> <li>- storage surface</li> <li>- ventilation openings</li> </ul>	<ul style="list-style-type: none"> <li>- room with south-facing windows</li> <li>- operations of devices for shading, glare control, movable insulation</li> <li>- overheating, ventilation</li> <li>- privacy, security</li> <li>- maintenance</li> <li>- selection of finish material (fading, color)</li> </ul>
<p><b>Storage Wall</b></p> 	<ul style="list-style-type: none"> <li>- movable insulation</li> <li>- storage</li> <li>- hybrid or passive system</li> </ul>	<ul style="list-style-type: none"> <li>- south side is used for the collector system (little direct or indirect gain for the room)</li> <li>- generally simple regulation</li> <li>- maintenance problems when using a vented storage wall</li> <li>- lack of view / ventilation, unless combined with direct gain features</li> </ul>
<p><b>Air Collector</b></p> 	<ul style="list-style-type: none"> <li>- storage mass disposition:               <ul style="list-style-type: none"> <li>- passive</li> <li>- hybrid</li> </ul> </li> <li>- suitability especially for light-weight construction</li> </ul>	<ul style="list-style-type: none"> <li>- acoustic bridges may occur when using hollow mass construction or air ducts</li> <li>- reverse air flow has to be controlled</li> <li>- maintenance problems for the interior surface of the glazing</li> <li>- tendency to air draught and dry air</li> </ul>
<p><b>Sunspace</b></p> 	<ul style="list-style-type: none"> <li>- sunshading</li> <li>- storage               <ul style="list-style-type: none"> <li>- passive</li> <li>- hybrid</li> </ul> </li> <li>- ventilation               <ul style="list-style-type: none"> <li>- bottom</li> <li>- roof</li> </ul> </li> <li>- security glazing of tilted areas</li> </ul>	<ul style="list-style-type: none"> <li>- sunspace can be used as complementary room</li> <li>- energy gain, easy regulation</li> <li>- combination with back up air heating system</li> <li>- overheating problems</li> <li>- system control</li> <li>- sooting of glazing</li> <li>- higher temperature swings</li> <li>- higher humidity</li> </ul>

Occupant acceptance of a certain low energy passive solar concept is mainly dependent on system advantages. In most cases, cost/benefit calculations influence or even define the design decision. On the other hand, there are several arguments which go beyond economic computations: qualitative aspects of space use, use of a sunspace as a greenhouse, thermal comfort from radiant heating systems or aesthetic advantages from daylighting concepts and usage of glass areas characterize the decision making process, as well. Therefore, early consideration during the predesign stage is necessary to clarify the energy gain systems, and their advantages, costs and consequences for the design and for the occupant. This discussion must be held in cooperation with the client. Issues concerning system efficiency vary according to climatic conditions, and system dimension should consider the material design guidelines (see Booklet 3, Design Guidelines).

## Qualitative Aspects

Passive buildings vary in the means used to collect, store and distribute solar gain. For direct gain systems, for instance, occupants need to be aware whether their choice of and location for furniture and room-dividers, wall, floor and window coverings support or undermine solar functions. In particular, they will need to be aware that their windows are essential elements in the passive contribution to the environmental and energy performance of their house. Common window treatments such as curtains or blinds may obstruct desirable solar gain. Interior spaces should be thought of as being composed of two elements:

## Direct Gain

- a thermal zone in which solar gain is collected, and
- a non-thermal zone which does not directly receive sunlight.

Households that do not discriminate between these two zones may run two different risks: first, they may impair the efficiency of their passive system operation, and second, they may damage their furniture, equipment, fabrics, or wall and floor coverings through exposure to direct sunlight. So occupants need to be advised where and when they are likely to run either of these risks.

With indirect gain systems such as sunspaces, different factors affect the use of space. Attached spaces and their utilisation are examples of the complexity and interdependencies between users' intention, energy issues, heat gain and losses, construction features, (materials, thickness, etc.) and orientation (solar gain, view).

Therefore, the very first discussion focuses on the question of space use, which is defined by the kind (quality), duration, and timing of use. Independent of its orientation, an attached space generally acts as a buffer zone from the energy point of view (see page 47). South facing and glazed, it additionally acts as a solar collector; a poorly covered (leaky) building shell can only work as an airlock. In addition, the intended duration (sporadic, temporary, permanent) of use defines, among other things, the type and quality of construction and the specific heat demand.

## Indirect Gain

Working as a passive or hybrid system, a sunspace should be used temporarily by the occupant due to the climatic conditions. In cases of greenhouse utilization, a heating system is probably necessary to maintain a minimum temperature of 7 °C to protect permanently the subtropical plants in the sunspace. Depending on the requirements specified by users' intention, the development of initial and operating costs do increase: the higher the requirements, the higher the costs.

This fact should be clarified, and the challenge begins in the very early pre-design stage. In many cases the imagination of a prospective client

## USER INFLUENCE

---

is characterized by an expected increase of amenity, encouraged by well-done photographs of the sunspace atmosphere illustrated in architectural magazines.

On the one hand, sunspaces became highly fashionable in residential building design during the last few years. This can be interpreted as a growing interest and consciousness for solar and low energy design.

On the other hand, the increasing demand has also created an attractive market for a steadily growing number of sunspace manufacturers promoting attached sunspaces, especially for retrofit design. However, clever advertising for both amenity and energy saving by sunspaces often mislead when information about the actual energy benefits and the complexity of a sunspace solar system are missing. Thus, only the experienced and product-independent designer can provide sound information and consultation in sunspace design to avoid unfortunate surprises and troubles for the client.

Question:	Total	New Building	Retrofit
How would you use a sunspace?	384	218	166
weather independent use of terrace, balcony	41.6 %	39.9 %	43.4 %
location for plants	37.7 %	36.2 %	39.8 %
climatic buffer zone, energy savings	33.0 %	35.3 %	30.1 %
additional living room, room extension	19.0 %	18.3 %	19.3 %
improvement of living quality	17.4 %	16.1 %	19.3 %
sound insulation (noise protection)	2.6 %	2.8 %	2.4 %
others	1.3 %	9.5 %	2.4 %
multiple indications	152.6 %	149.1 %	156.7 %

*Figure 5.8*

The increasing demand for sunspaces by clients and owners relates to new building design and retrofit as well. Occupants' intentions tend towards a maximum full-time sunspace use, increasing amenity values, and energy benefits at the same time. These often contradicting requirements need to be checked against each other very carefully.

(Investigation covering 384 clients, interviewed by a German magazine)

Question:	Total	New Building	Retrofit
Should your sunspace be usable all year round ?	384	218	166
Yes	81.2 %	79.6 %	82.7 %
No	18.8 %	20.4 %	17.3 %
Total	100 %	100 %	100 %

# USER INFLUENCE

Aside from energy aspects of users' relationship to sunspaces, a serious lack of information exists about the conditions and consequences when a sunspace is equipped with vegetation. Whether it serves as a year-round houseplant space or for greenhouse use, only a carefully selected disposition of plans suitable for the corresponding purpose may guarantee the expected amenity and success. The most important determinants for sunspace vegetation are light quality and quantity (orientation, direction and distribution of light); humidity level; kind, distribution, and intensity of vegetation; presence of pesky insects (i.e., spider mites, wool-louses) often caused by insufficient humidity levels; minimum / maximum temperature levels according to the physiological demands of vegetation; quality and quantity of soil (kind, depth, and construction of containments); watering and shading control devices.

**Figure 5.9**  
Suitability of vegetation in a sunspace versus evaluation of space use and orientation.

EVALUATION OF SPACE USE		VEGETATION								
		none			moderate			intensive		
		Orientation								
		S	E/W	N	S	E/W	N	S	E/W	N
never	Type	B	B	B	G	B	B	G	B	B
	Energy	+	+	+	+	+	+	o	o	o
	Moisture	+	+	+	o	o	-	o	-	-
temporary	Type	WG	WG	B	WG	WG	WG	G	WG	WG
	Energy	+	+	+	+	o	o	o	o	o
	Moisture	+	+	+	o	o	-	o	-	-
permanent	Type	L	L	///	L	L	///	G	///	///
	Energy	-	-	-	-	-	-	-	-	-
	Moisture	+	+	+	o	-	-	-	-	-

Caption of Symbols	
Type of Sunspace	Specification
B	Buffer
WG	Wintergarden
L	Living Room
G	Greenhouse
///	not applicable
Energy Saving	Problems of Moisture
yes	+
limited	o
no	-
	big

CLIMATE	GLAZING	ORIENTATION	SPACE USE	NOCTURNAL INSULATION
mild and sunny	single glazing	south	seasonal	no/yes
moderately cold and sunny	double glazing	south-east to south west	seasonal	no
cold/extremely cold, moderate sun	double glazing	all directions	intermittant use in winter	yes
cold moderate sun	double glazing gas filled	south	seasonal	no
cold/extremely cold, moderate sun	double glazing gas filled	south	permanent use in winter	yes
extremely cold less sun	triple glazing low-e-glazing	south	extended seasonal use	no
intermediately cold	triple glazing low-e-glazing	west, north east	seasonal	no
moderately/ extremely cold less sun	triple glazing low-e-glazing	all directions	permanent use in winter	yes
moderately cold moderate sun	double glazing heat mirror®	west, north east	extended seasonal use	no
extremely cold moderate sun	double glazing heat mirror®	west, north east	permanent use in winter	yes

**Figure 5.10**  
The table gives a rough estimation of correlations between thermal quality of glazing, climatic conditions and space use without auxiliary heating system.

Duration of sunspace use depends on its thermal comfort situation. As a buffer space a greenhouse will generate an intermediate climate due to the ambient air and radiation conditions. Kind and quality of the glazing and the construction features (material, thermal breaks, etc., see Booklet 5, Construction Issues) will determine the heat losses of the sunspace. Additional movable insulation devices may increase daily space use duration and could also act as sun protection to avoid overheating in summer, when the sunspace is facing south.

# USER INFLUENCE

Space conditioning systems for passive / hybrid designs can be more complex in operation than conventional central heating systems of common residences or even other kinds of low energy homes. Solar gain becomes a highly significant variable (that is, both intermittent and, to a certain degree, unpredictable). Living in a passive solar home is therefore determined by different characteristics of energy performance of the building and, though to varying degrees, by the dynamics concerning living habits and thermal comfort variations which for the present may be uncommon for inexperienced occupants. However, adequate information about the "philosophy" of the passive solar residence will help him learn to overcome traditional using behaviour and will assist his understanding and education.

Figure 5.11  
Variations of buffer spaces determined by temporal utilization patterns versus the typology of bioclimatic and energy-related effects.

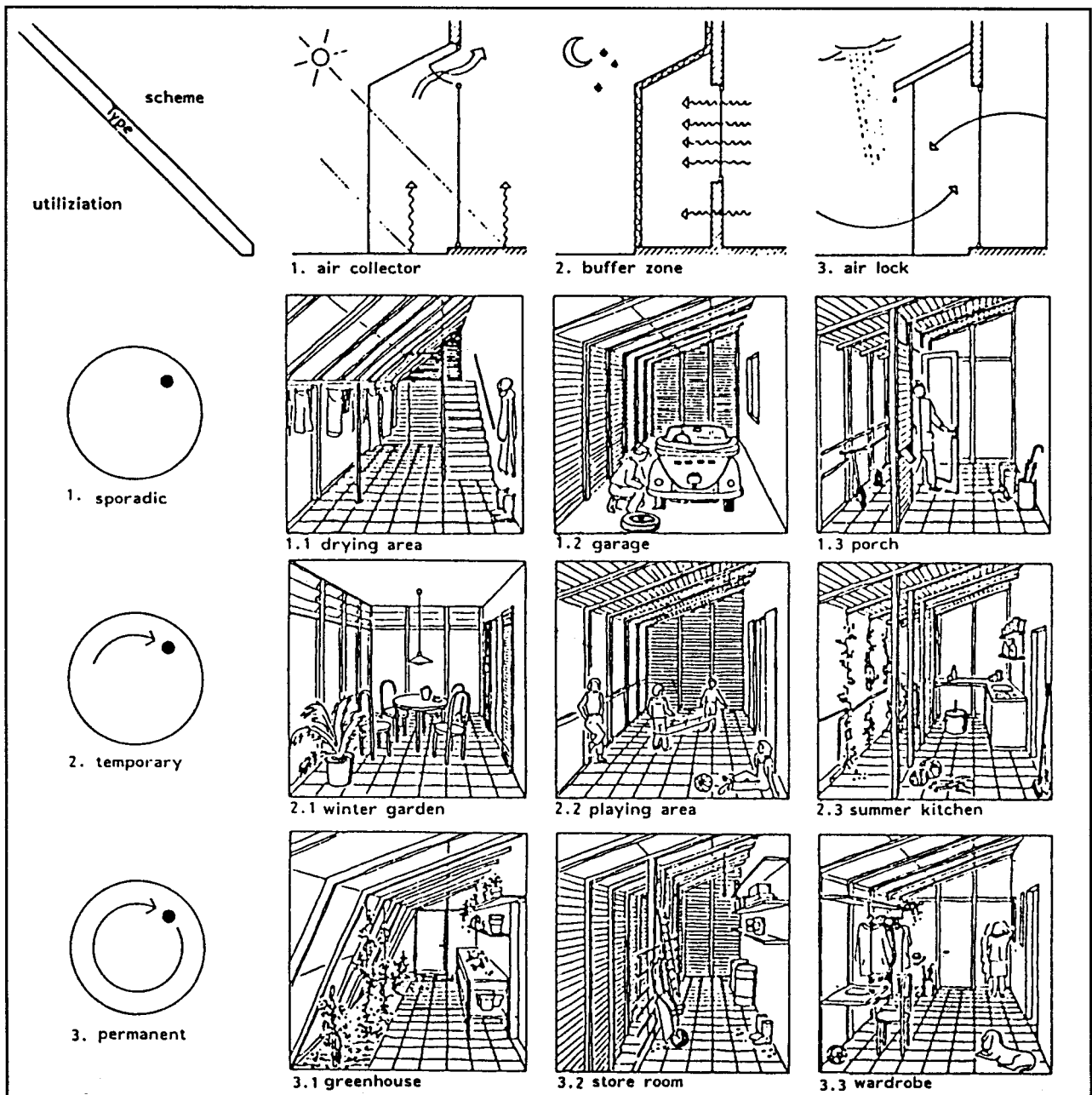



In passive solar homes, the design of controls is important for two reasons: first, because making use of potential solar and other internal gains (e.g., from occupants themselves and household activities like cooking) depends on appropriate setting of heating controls by the occupant. Second, because of higher levels of insulation, the size of heating systems can be reduced. Boilers can be smaller and the size, number, and position of heat emitters becomes more critical to occupants' perception of the responsiveness of their house as a whole, or of certain rooms in particular, to their heating demands. A heating/cooling/ventilation control system should be chosen which

## Heating Control

- allows zonal as well as time control,
- is effective and efficient,
- has easily understood operations, and
- performs in accordance with occupants' expectations.

Occupants have developed to their individual ventilation and heating habits according to their experiences in conventional homes or other kinds of low energy residences. To date, the desire for energy economy and the experience of the unresponsiveness of conventional heating systems may have been realized by operating the heating intermittently and/or leaving unoccupied rooms unheated, and then attempting to heat up a room instantaneously when using it. Moreover, ventilation may have been provided by opening windows for a longer time without turning down the heat (to maintain thermal comfort). Others are actually unexperienced in ventilating because the leakiness of their former homes represented permanent natural ventilation.

## Ventilation and Condensation

In pursuit of energy efficiency, passive solar homes are likely to have lower rates of natural ventilation. Under these circumstances, such heating strategies may give rise to condensation. So occupants will need information and guidance to cope with this possible risk. They need to know where, when and for how long to use natural ventilators and/or run mechanical ones without incurring unnecessary energy costs.

Occupants in passive homes may not wish to be treated as pioneers whose houses are an experiment in a still developing field. Nor are they likely to invest time, effort or money in trying to correct or modify imperfections (no matter how minor) in their passive systems. However it will be helpful if they do understand the basic principles of passive design. And they will require sufficient detailed information about their home's intended performance to be able:

## Operation of Systems Components

- to respond to operational measures that are expected of them (e.g., adjusting blinds, shutters, thermal curtains or vents), and
- to comprehend how solar gain is meant to be collected, stored and then distributed throughout the interior of their house and how and when sunlight must be controlled efficiently.

They will also need to know what daily and seasonal actions (if any) are involved in operating their system effectively. And, they should be aware if personal judgements or assessments - for instance, about prevailing or predicted weather conditions - are expected of them in order to safeguard the efficiency of their system. Where manually operated shutters or vents are provided, the occupants must be sufficiently

# USER INFLUENCE

---

informed to be able to choose whether they should be opened or closed. When designers incorporate either solar control devices or controls for heating/cooling/ventilation systems in their schemes they need to pay attention to more than just their technical specification and performance. They also need to consider them in relation to occupants' own expectations, aspirations, preferences and priorities. If these are unknown or unexplored, as they are in most of the design guidance literature to which they have access, then designers must as a guiding principle consider precisely how such devices and controls have to be operated in order to support their scheme's passive performance, and the consequences of their non-use, misuse, and abuse by occupants.

## Movable Insulation Devices

Use and misuse of movable insulation devices determine the heat losses at night through glazing areas. Beside technical requirements which are discussed in chapter 3 and in Booklet 5, a series of functional decisions are crucial for occupant acceptance:

- indoor or outdoor location
- storage of the insulating elements
- manual or automatic operation
- initial and operating costs
- maintenance
- durability/reliability over extended time
- ease and comfort of use
- weight, depending on ability to move
- design of device and surface
- multifunctionality (i.e., translucent insulation, summer shading blackboard, pin wall)
- installation of solar systems to substitute for fossil energy sources
- modification of floor plan by reorganization and spatial assignment
- development of buffer zones and/or sunspaces to reduce energy losses, gain solar energy and improve living quality
- improvement of technical systems for increasing system efficiency

The effectiveness of movable insulation is unquestioned when properly used by the occupants. However, the requirements for users' acceptance depends on the designer's ability to fulfill reasonable operation and cost/benefit expectations.

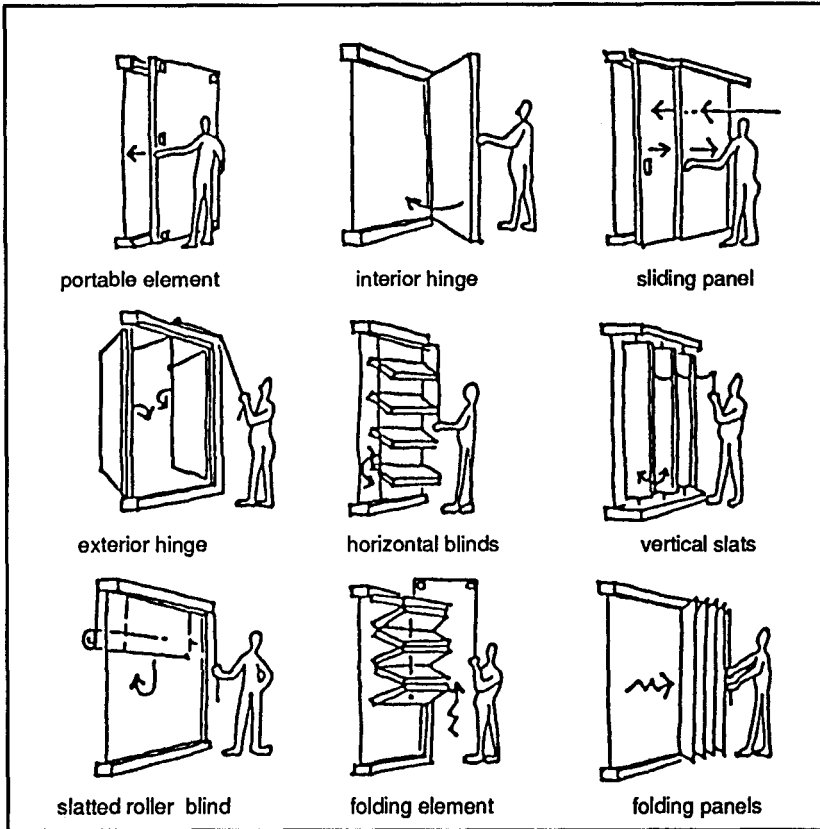

*Figure 5.12*  
Survey of different exterior and interior  
movable insulation devices for glazing  
areas.

Disregard of these issues may jeopardize not only the successful passive performance of the building design, it may also render a house less acceptable to its occupants. Lack of attention to such issues may result in homes that fail to fulfill their designers' intentions in terms of their energy consumption or their environmental performance, and/or, fail to meet their occupants' needs and expectations about the nature of their home, about the features it should incorporate, and about the facilities it should deliver.

Thus, information and advice for occupants about the energy design, the intended system performance, and control strategies of their homes are an unalterable pre-condition for a successful passive solar building and occupants satisfaction.

For further reading about the evaluation of occupant satisfaction and thermal performance evaluation, see Booklet 8, Post-Construction Activities.



*Figure 5.13*

Sliding insulation panel as movable device behind the sunspace glazing. Multi-story residential demonstration building of IEA Task VIII in Berlin, F.R. of Germany (see Booklet 6, Passive Solar Homes: Case Studies).

Design: IBUS GmbH, Berlin  
G. Hillmann, J. Nagel, H. Schreck,  
co-op P. Kempchen, M. Güldenber

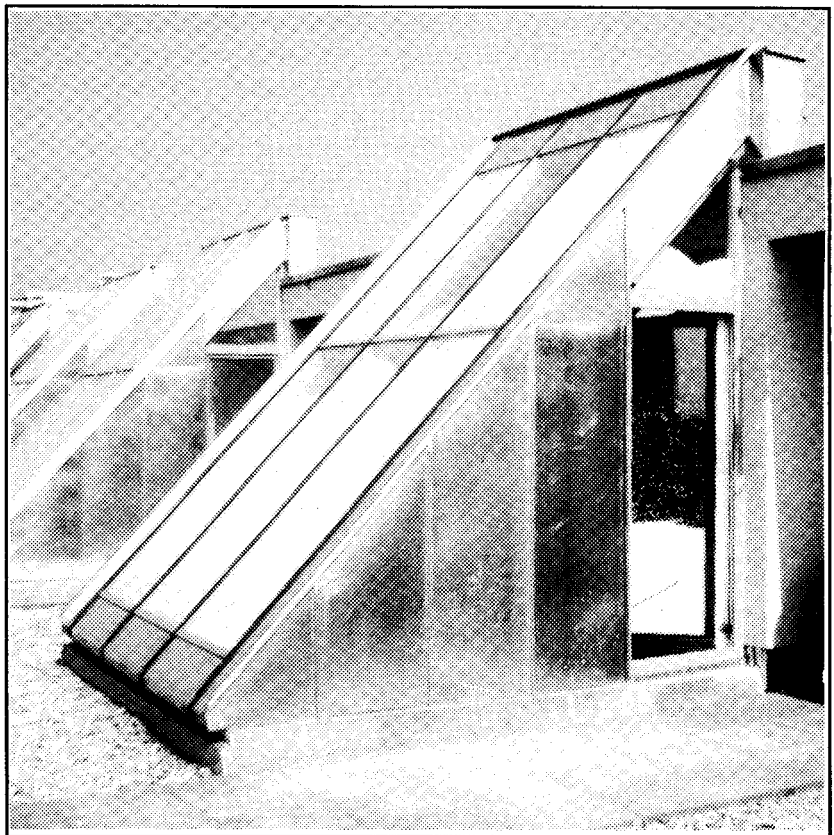

*Figure 5.14*

Improvement of beadwall® principle by G. Löhnert for the IEA Task VIII building in Berlin, F.R. of Germany.

The different sections of the sloped glazing can be changed individually according to climatic conditions and user's requirements upon thermal insulation in winter, solar shading in summer, protection against insight into the apartment, and protection against glare. The insulation system also includes the tilt-turn element which provides access to the roof terrace .

It is probably fair to say that all planning, design and construction projects are governed by national, regional and local land use and building standards, codes and ordinances. Consequently, the design of buildings based on bioclimatic design principles must recognize these codes and regulations and comply with them. Since bioclimatic design principles are often not considered in these regulations, conflicts can arise.

Of course, it is impossible to give global recommendations to the designers of how to meet the potential requirements and restrictions of their specific location and corresponding codes and regulations.

The variety and diversity of model codes, state, federal and city codes, different federal, industry and owner standards as well as the various research recommendations of each country may illustrate the importance of this subject.

The following chapter presents a general discussion of the type of conflicts or issues resulting from legal issues that may arise between bioclimatic design principles and building codes and regulations.



*Figure 6.0*

**Building codes and building shape:**

The architectural appearance of this residence is a compromise between the dictated saddle-shaped roof including the orientation of the ridge and the intention of the client and the architect for bioclimatic solar architecture.

Consequently, the design resulted in a house-in-house concept providing a sun-space envelope around the entire building according to the regulations. However, the floor plan has been turned within the envelope due to the solar exposition.

# BUILDING CODES AND REGULATIONS

---

## Checklist

### Urban Planning Restrictions and Zoning Regulations

- Analyze the developed site relative to building lines and boundaries concerning solar access.
- Identify any regulations or requirements concerning building development in length, depth and/or height (floor space index, ground area index, building spaces)
- Identify the main pedestrian and traffic access locations (they have an influence on building access, design and usage of interspaces).
- Identify the conditions concerning parking. They may have an effect on solar access and building layout.
- Identify areas of site that are not usable because of building boundaries, location of service lines, supply installations and adjacent buildings.
- Check restrictions concerning building development: shape and slope of roof, application of building materials and architectural design directions.
- Identify factors of energy supply which have an impact upon reasonable energy use (i.e., district heat, gas, and electricity).

### Restrictions Based on Preservation Codes (Regulations)

Conditions which influence bioclimatic design (solar access and energy supply):

- Identify any protected vegetation, i.e., trees of certain diameter of trunk or top which are not allowed to be cut down.
- Identify local restrictions and requirements based on preservation of ancient monuments, historic landmarks.
- Identify restrictions concerning water and energy supply and discharge network, e.g., water preservation areas.

### Regulations Concerning Building Codes and Industry Standards

Different building codes and industry standards have to be checked for minimum - maximum requirements upon:

- occupant load
- natural lighting
- electric lighting
- temperature control
- humidity control
- thermal transmission of building components
- air tightness of building components
- natural and mechanical ventilation
- sound insulation
- safety / egress
- fire protection

**Check Necessity of Planning Permits at Your Specific Location**

# BUILDING CODES AND REGULATIONS

Zoning regulations have their origin from master plans of urban developments which segregated industrial uses, presumed to be dirty and noisy, from residential uses. Consequently, these regulations have an essential impact on microclimatic conditions (see section 1) as they define location, size, and utilization of public areas, such as parks, traffic lanes and agricultural land reserves. Typically, they form restrictions and commitments which cannot be changed. These mandatory requirements concern, for instance:

- Location of properties within a certain development
- Kind of site utilization, i.e., residential, or commercial purposes.
- Measure of building utilization on site by limitation of structural density, defined by floor space index and space use index.
- Limitation and/or determination of building location on site.
- Building configurations and location on site (orientation).
- Kind of building structure, i.e., detached homes, row house development, low density structures, multi-story buildings, and so on.
- Limitations of building height (number of stories).
- Requirements upon the shape of roof, i.e., defined roof tilt angle, flat roof, and so on.
- Determination of material options concerning design of facade and/or roof may be given by local regulations in cases of redevelopment of historical environment and protection of monuments.
- Style of homes, local design regulations.

## 6.1 Zoning Regulations

*Figure 6.1*

Comparison of conventional building structures (a), and bioclimatic approaches (b).

Each kind of building structure should support free solar access to the individual building and promote adequate protection from traffic noise. Independent of the main orientation of traffic lanes, these requirements are always possible, whether for detached homes, row-houses, or dense flat structures.

Staggering and / or turning of buildings does not necessarily cause renunciation of economic utilization of land, but often effects an increase of privacy by creation of individually improved outdoor spaces.

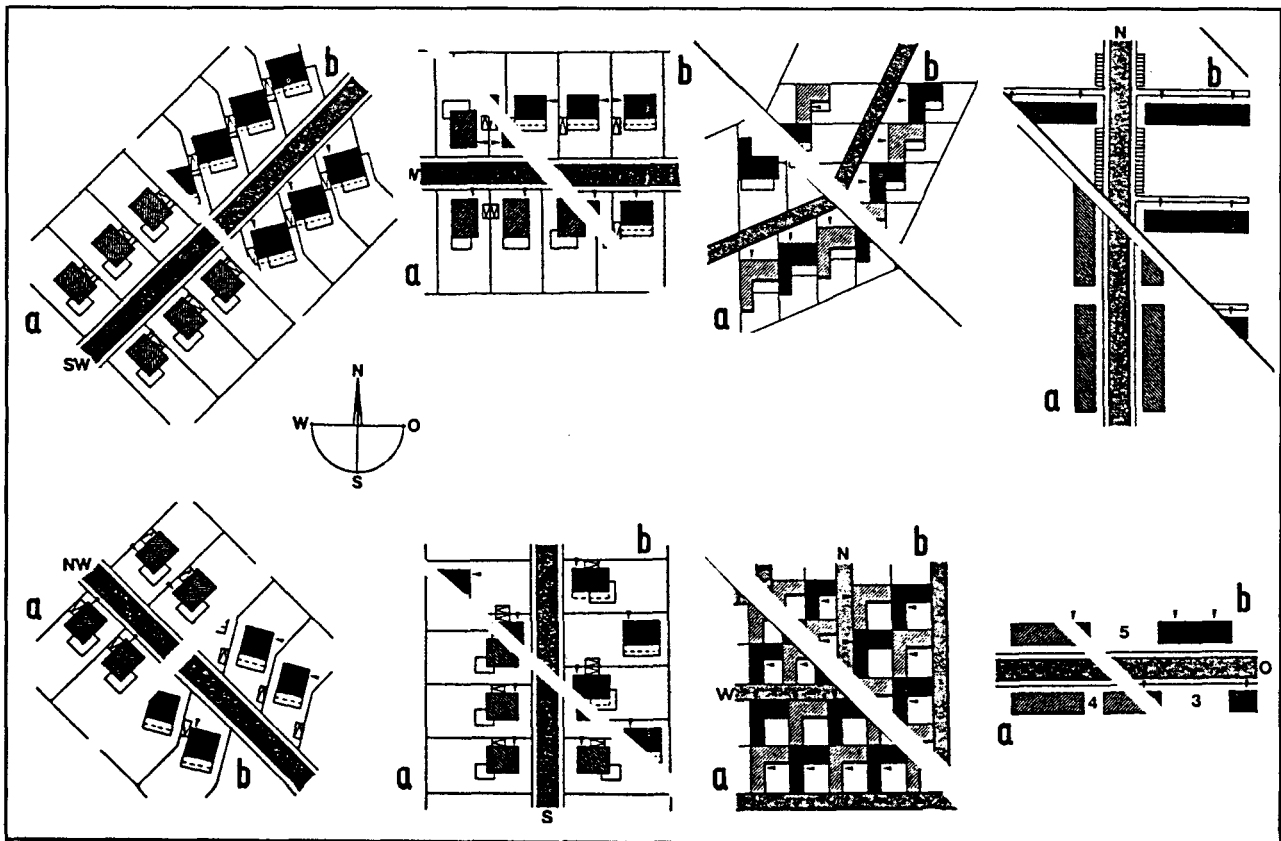

# BUILDING CODES AND REGULATIONS

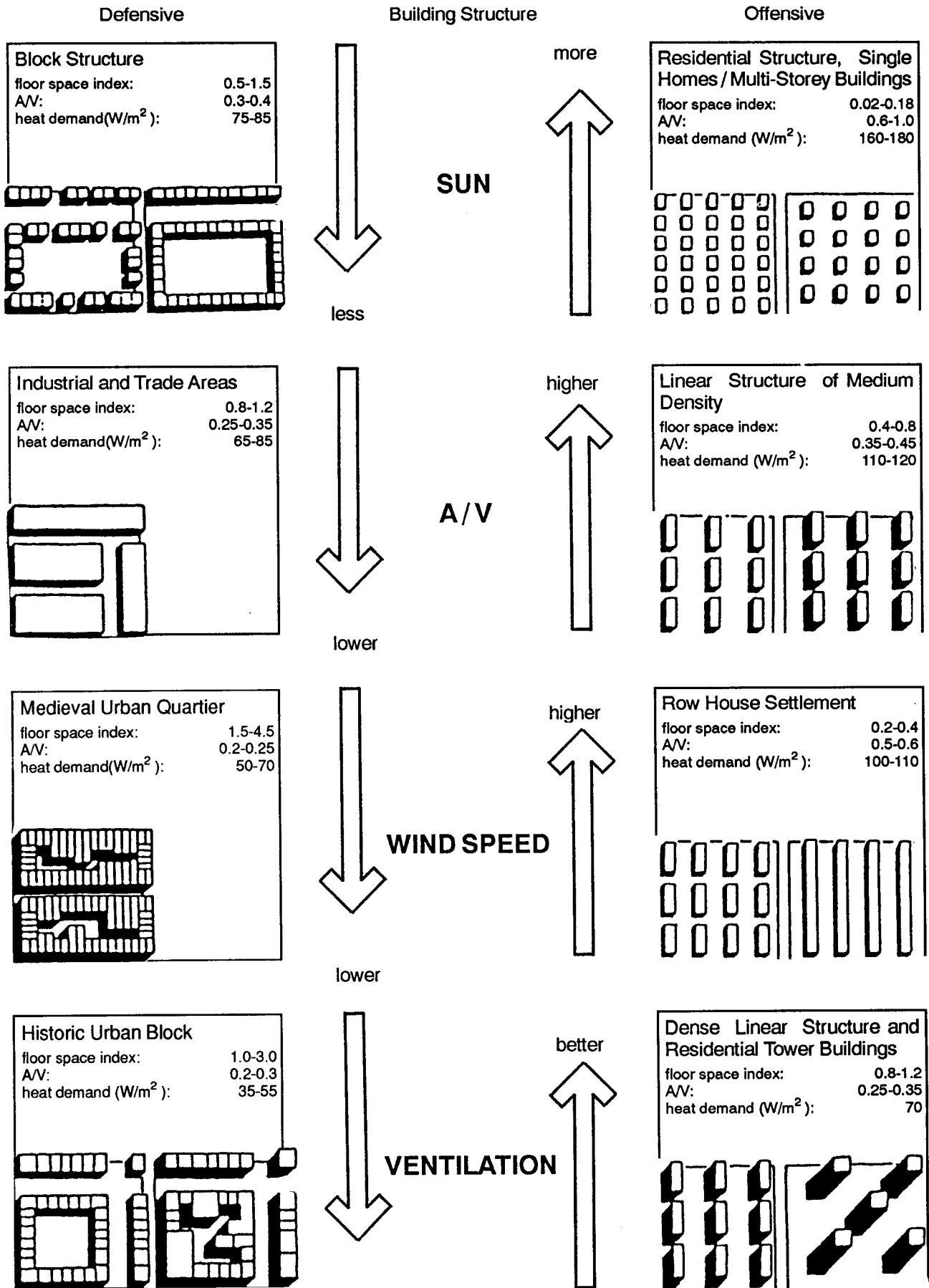

Figure 6.2



# BUILDING CODES AND REGULATIONS

Development of urban spaces depends on economic, political, technical and social decisions, as far as they agree with - or even define - urban developments. In view of increasing land costs - whether urban, suburban or country side - and energy costs, a need exists for space and energy saving building concepts. Numerous investigations have shown that dense settlements have essentially lower energy demands (60%) in comparison with open detached home structures. Further advantages are lower costs of site development and improvement of efficiency of centralized supply systems (technical, commercial and social). Disadvantages of dense low-rise structures are the reduced character of ownership and missing individuality. With regard to steadily increasing operating costs of conventional single family building structures, the trend will be towards higher density. Because of the complexity of building and settlement patterns, there is no hierarchy of different means, but the most important should be the promotion of:

- Adequate building structures concerning building height and density.
- Compactness of building structure.
- Unobstructed access for daylight and utilization of solar energy.
- Adaption and exploitation of natural micro-climatic conditions.
- Development of decentralized energy efficient supply systems.

Zoning codes and regulations should encourage environmental, bioclimatic and energy saving settlement patterns. Indirectly these regulations also determine energy supply systems for residential developments, depending on the national, regional or local supply of energy sources.

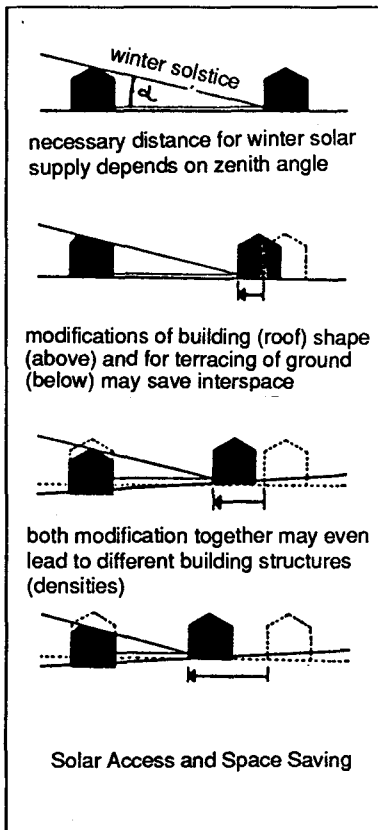

Figure 6.3

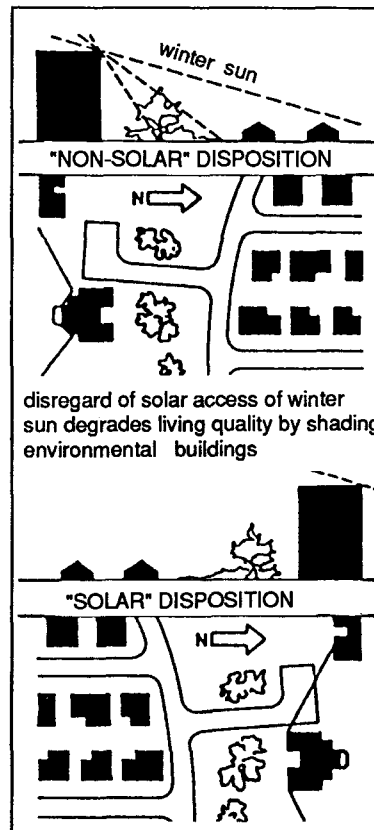

Figure 6.4

Moreover, industrial energy-economic interests represented by official goals of energy politics may conflict with reasonable environmental and solar energy utilization.

**Example 1:**

Master plans may compel the supply of district heat which requires a minimum heat consumption, and the common mode of clearance depends on square meters of floor area. This way, energy benefits cannot be achieved and the regulations directly counteract and prevent solar approaches.

**Example 2:**

From the energy point of view, a heatpower-co-generation plant for small settlements is the most efficient and decentralized energy generation system. Properly designed, their capacities could also allow for solar energy gain of individual residential units. Common practice, however, is a negative attitude of authorities, not to mention an encouragement for those concepts.

*Figure 6.6* Gain of public green areas: In comparison to flat blocks which cover a large ground floor area multistorey buildings of the same floor area create considerable green inter spaces. However, the increase is disproportional to building height. This contradicts public opinion which says that high building structures like tower buildings would protect green areas. Theoretically, the relation of floor space to green and the relation of square meter per green area and person will increase. Conscious and responsible design, however, should consider qualitative aspects of relations between building and green as well as the quality of interspaces themselves. An optimum building height of four stories should be achieved.

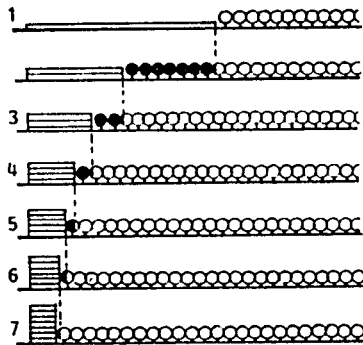

*Figure 6.7* Multi-story building design allows an increase of green interspaces by increasing the building depth related to the same height of building and the same space use index. This means the same space with less built-up areas as well as an improvement of energy balance. In other words: an increase of 2 m of building depth increases the interior spaces by 6 m, relating to a 4-storied building which should be the limited building height.

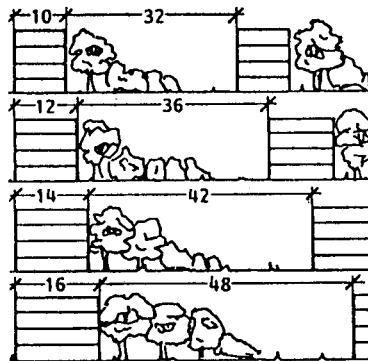

*Figure 6.8* Row-house structures allow a better use of green areas at equal size of site. This leads to fewer cut up, unusable lots. Less areas of badly cut remainders and their small pieces are hardly usable. The number of pathways is reduced and the shaded areas per housing unit are essentially smaller. Energy conscious design should intend to create dense, low-rise building structures with high quality interior spaces adjoined to the housing units and the guarantee of solar access.

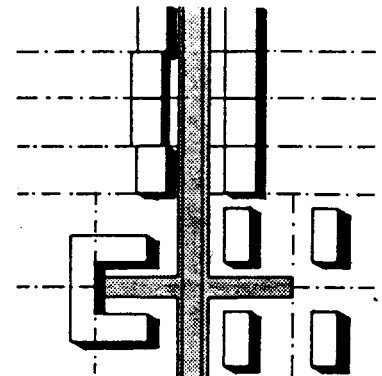

# BUILDING CODES AND REGULATIONS

Generally, building codes will have national, regional or local authority regulating all building site processes. The purpose of building codes is to ensure that buildings provide reasonable standards of health and safety for their occupants. The establishment of regulations are historically well-founded by geographic, national and federal legal and administrative developments of countries. Codes are affected by corresponding cultural and climatic background, and the technical experience and development of building technologies.

Impacts related to building design mainly concern construction, physical and technical requirements and also the pattern of building documents.

Passive solar systems use building components for energy collection, storage and distribution. Moreover, the floor plan is carefully organized so that systems efficiency is increased by minimizing energy losses and maximizing useful solar energy gains. Thus, the entire building acts as a solar system, more or less, and its participating components take over dual functions in most cases. Therefore, they have to fulfill their specific demands of solar performance, and meet the requirements of building codes as well.

Though these requirements may differ from country to country (see figure 6.10) and have mostly been set for county or municipal level, selected considerations of general concern will be given in this section as they relate to, or even contradict, energy conscious and passive-hybrid solar designs for residential buildings.

## 6.2 Building Codes and Industry Standards

**Figure 6.9**  
Survey of codes, regulations, and industry standards which have an energy-related impact on specific building characteristics. The example illustrates German conditions; variations may occur due to the individual countries.

Impact upon Building Design	size of room and residential unit	room height	building geometry, number of stories	use of building	residential and structural development	location, residential area	window area, orientation	equipment of spaces and building
Legal Appointments								
building code	●		●		●	●		
land use act			●	●	●	●		
building regulation		●	●		●	●		●
zoning regulation			●		●	●		
housing law regulation of housing financing	●	●	●	●	●	●	●	●
various industry standards (exemplary F.R. Germany)								
DIN 18 011 usage of floor area	●			●				●
DIN 18 022 service rooms	●			●				●
DIN 5 034 daylight requirement							●	
DIN 4 108 thermal insulation			●		●		●	

# BUILDING CODES AND REGULATIONS

---

Energy Conservation	<p>The statutory limitation of thermal transfer (maximum overall U-value) through the building envelope may limit the number and size of glazing areas in exterior walls and roof and may imperil the reasonable utilization of a solar energy system. Compliance with the temporal weighted thermal resistance of movable insulation as a part of a direct gain or storage wall system could meet the requirements. Common practice, however, requires expensive annual energy simulation techniques to prove the energy efficiency of a non-standard design (see Booklet 4, Design Tool Selection and Use) comparable to that which meets the prescriptive standard. Therefore, it is necessary to shift from building component-related standards to performance-based approaches for home energy consumption to provide credit for passive solar strategies.</p>
Daylighting	<p>Window areas of at least 5% of the floor area are general minimum requirements for habitable rooms to provide sufficient natural light. Some building codes restrict maximum distance from the aperture in the exterior wall (i.e., for working spaces of interior kitchens <math>d \leq 6</math> m). Some solar designs eliminate all windows for specific room locations which are appendices of an adjoining room of the open ground floor layout. For these cases it would be desirable to consider the isolated room as part of the daylit room when the partition wall provides 50% of opening and the window fraction of the daylit room meets 10% of the combined floor area, and windows should be replaceable by skylights. Also daylighting reflectors or light shelves directing sunlight into interior rooms such as dining space or interior kitchens are not sufficiently considered by codes.</p>
Natural Ventilation	<p>Some building codes link the operable window area, which should not be less than half of the required glazing area, or minimum required ventilation area as percent of floor area. Others call for minimum air changes exclusively, which relate to the air volume of habitable rooms. Problems may arise when meeting ventilation requirements for sunspace designs if the adjacent room has no separate window directly to the outside and fresh air supply is only possible via the sunspace.</p>
Wall and Roof Components	<p>Wall, roof, and ceiling coverings or panels may be restricted by regulations concerning their construction, structural stability, combustibility, thermal quality and so on. For the classification of an air collector, the problem arises whether it should be treated as a building component or covering, or panel. The most reasonable classification should relate to construction and integration of collectors into the building envelope.</p>
Firestopping	<p>Openings have to be firestopped to avoid the spread of fire within concealed spaces. Air collectors extended over more than one story or several roof supports; using the "stack-effect" for distributing the heat into the building requires free draft openings. Depending on construction material, combustible components should be equipped with smoke-activated fire dampers between each floor level and each support in the roof. For non-combustible components the smoke cut offs could be installed at each supply and return air vent to provide sufficient security against the spread of fire. Sunspaces of neighbouring dwelling units require a non-combustible partition wall resistant against fire. This requirement can only be met by an opaque fire wall which could destroy the solar and daylighting approaches of the building design or by an expensive fire resistant glazing. A similar restriction may arise when sunspaces exceed the minimum distances to the neighbouring buildings. In those cases common practice to obtain building permission is characterized by a great diversity. Different definitions of a sunspace - restricted by height volume, floor area, controlled or not controlled, considered as a habitable space or not - and the assumptions of existing fire risks require that the designer pay careful heed to such regulations.</p>

# BUILDING CODES AND REGULATIONS

Every sleeping room in a residential building requires an operable window or door serving for emergency exit in the case of fire. Depending on the solar design, it may be desirable to limit the daylighting of this space to a small skylight, an indirect window via another room, or even eliminate the windows in the building envelope. The installation of a smoke detector and a door directly into a corridor that has access to two remote exits may substitute for those requirements.

## Escape Routes

Figure 6.10 Global review of available requirements, standards and guidelines for residential sector (after IEA, Task XII).

Keynotes:

R Mandatory requirement

S Model standard or equivalent (i.e., generally used national / regional guidelines available)

r Other sources / recommendations available

E Requirements and/or guidelines only

applicable for exceptional cases

<sup>1</sup> Different per region

<sup>2</sup> In preparation

<sup>3</sup> Specific situation

<sup>4</sup> Caulking and weather stripping required

( ) Clarification required

X not investigated

SUBJECT	COUNTRY													
	A	B	CH	D	DK	F	GB	I	N	NL	S	SF	US <sup>3</sup>	
MINIMUM DAYLIGHTING e.g., min. window area	R	r	S	R	R	r	r	r	-	R	r	R	R	
MAX. THERMAL TRANSMISSION THROUGH WINDOWS U-values	R	(S/r)	R	R	R	r	R	-	R	R	R <sup>1</sup>	R	R	
MAX. THERMAL TRANSMISSION THROUGH EXTERIOR WALL U-values	R	(-)	(-)	R	-	-	(-)	-	R	(-)	-	-	R	
MAX. NET HEAT LOSS THROUGH WINDOWS CONSIDERING ENERGY GAINS e.g., by equivalent U-value	r	-	R	r	-	R	-	-	R	(R <sup>2</sup> )	-	-	-	
MAX. OVERALL TRANSMISSION OR ENERGY CONSUMPTION e.g., mean U-value or G-factor	R	R	R	R	r	R	(S)	R	(r)	R <sup>1</sup>	R	R	R	
MAX. THERMAL LOAD IN SUMMER e.g., max. window area	R <sup>2</sup>	R	R <sup>2</sup>	R	-	r	-	r	r	(R <sup>2</sup> )	-	-	E	
MIN. AIRTIGHTNESS OF WINDOWS e.g., max. leakage factor	X	R	R	R	X	X	S	S	R	R	X	X	R	
MIN. AIRTIGHTNESS OF BUILDING e.g., max. leakage factor	X	-	-	R	X	X	-	-	R	-	X	X	E	
MIN. ACOUSTICAL INSULATION e.g., dB attenuation	X	S	R	R	X	X	R	-	-	E	X	X	-	
MIN. SAFETY REQUIREMENTS	X	-	-	R	X	X	S	S	-	-	X	X	R	
FIRE	X	-	-	R	X	X	R	S	-	-	X	X	-	

# BUILDING CODES AND REGULATIONS

Figure 6.11 Survey of minimum requirements of codes, regulations, standards (after the Ehrenkrantz Group, 1978).

- AC = Air Change/hour                      Keynotes  
 CO = CFM/occupant  
 CS = CFM/square meter  
 CW = CFM/water closet  
 lux = lux, 76 cm above floor  
 GSM = Gross Square Meter/occupant  
 MA = Minimum required window area (m<sup>2</sup>)  
 NR = No Requirements  
 NSM = Net Square Meter/occupant  
 RH = Relative Humidity  
 SB = Setback Temperature  
 G = Glazing as percent of floor area  
 V = Operable Vent as percent of floor area

The codes, regulations and standards surveyed in figure 6.11 have different origins and different concerns, and, as a result, often contain different criteria. As a general rule the model codes and state and city building codes are mainly concerned with life safety and deal with environmental requirements in relatively brief terms. These codes often make a general statement applicable to all habitable or all occupiable spaces.

The matrix includes four model codes, eight state codes, eight city codes, and a wide variety of professional and owner standards. The designation of criteria as minimums does not mean that they must be used, or that

The minimum acceptable or recommended quantity for the criterion within codes and standards surveyed.  More than one is shown where units from different sources are incompatible.	Occupant Load	Natural Lighting	Electric Lighting	Temperature Control	Humidity Control	Natural Ventilation	Mechanical Ventilation		
							Supply Air	Outside Air	Exhaust Air
Apartment	10 GSM 30 GSM	5% G		18-27°C 13°C SB	20-60 RH	4% V	4 CO 2 AC	5 CO 0.4 AC	
Studio	10 GSM 20 GSM	5% G 1 MA		18-27°C 13°C SB	20-60 RH	4% V	4 CO 2 AC	5 CO 0.4 AC	
Basement		2% G	107 lux	18-26°C		0.2% V	5 CO 0.5 AC	5 CO 0.5 AC	
Bathroom		5% G 0.3 MA	32 lux	18-26°C 13°C SB		4% V 0.1 MA	20 CO 25 CW	20 CO 25 CW	20 CO 25 CW
Bedroom		5% G 1 MA	107 lux	18-26°C 13°C SB		4% V 0.5 MA	5 CO 2 AC	5 CO 2 AC	
Dining Room		5% G 1 MA	161 lux	18-26°C 13°C SB		4% V 0.5 MA	5 CO 2 AC	5 CO 2 AC	
Kitchen		5% G 0.3 MA	540 lux	18-26°C 13°C SB		4% V 0.3 MA	20 CO 4 AC	20 CO 4 AC	15 CS 4 AC
Living Room		5% G 1 MA	107 lux	18-26°C 13°C SB		4% V 0.5 MA	5 CO 2 AC	5 CO 2 AC	
Public Laundry	5 NSM	5% G 0.15 MA	320 lux	18-26°C 13°C SB		4% V 0.15 MA	0.3 AC	0.3 AC	10 CS
Mech. Service Room	30 GSM 30 NSM		54 lux	10°C MIN		NR	5 CO 4 AC	5 CO	
Public Circulation	20 NSM	5% G	11 lux	17-27°C 11°C SB		4% V NR	1.7 CS NR	1.7 CS NR	15 CS NR
Public Lobby	3 NSM	5% G	320 lux	18-27°C 11°C SB		4% V 0.15 MA	5 CO 0.3 AC	5 CO 0.3 AC	
Public Toilet	1 NSM	5% G 0.15 MA	32 lux	18-27°C 11°C SB		4% V 0.15 MA	10 CS NR	15 CO 10 CS	15 CO 4 AC
Stairwell			11 lux			NR 5% V	0.3 AC	0.3 AC	15 CS
Storage	15 GSM 30 NSM	5% G	54 lux	10°C MIN NR		NR 2% V	0.3 AC	0.3 AC	

# BUILDING CODES AND REGULATIONS

---

minimums can be compared with the full range of criteria found in other codes and standards. Thus, the information is simply a documentation. It has been compiled for designers to assist them in choosing appropriate performance levels for their design work.

Minimum Requirements

The following notes describe the selection and presentation of minimum criteria of the residential sector:

Occupant density is used to determine egress requirements, expressed in terms of net or gross m<sup>2</sup> per person, indicated by the abbreviations NSM and GSM. The two numbers in a box give the minimum (top line) and the maximum (lower line) of occupancy. Designers must decide which number is appropriate for their design.

Occupant Load

Minimum acceptable window area generally given as a percentage of the floor area (top line) of the space in question or an absolute minimum for the glazing in square meters (lower line) of the box. Daylighting may be substituted with artificial light for non-habitable rooms.

Natural Lighting

Minimum acceptable or recommended range of illumination levels given in lux at 76 cm above the floor. For stairwells and public circulation the values represent emergency egress requirements.

Electric Lighting

Minimum and/or maximum or recommended range of temperature given in degrees Celsius. Energy should only be used to prevent the temperature falling below the minimum (during the heating season) or exceeding the maximum of the "deadband". These values are taken from the surveyed codes and will not necessarily be represented in a specific code. Night setback temperatures are given in the lower line.

Temperature Control

Minimum and/or maximum or recommended range of relative humidity in percent, generally representing the minimum acceptable value for the heating season and the maximum value for the cooling season. It should be noted that most of the building codes stipulate only one range or even one figure concerning all habitable spaces.

Humidity Control

Minimum acceptable operable vent area as a percentage of floor area is given in the top line - a minimum stipulated area in square meters is given in the lower line.

Natural Ventilation

Consideration of mechanical ventilation requirements concern three categories of mechanical treatment of air which interrelate in any mechanical system. The values are generally given in cfm per occupant or per square meter and/or air changes per hour.

Mechanical Ventilation

Supply Air: Minimum acceptable quantity of air to the space including recirculated air, mechanically supplied.

Outside Air: Minimum acceptable quantity of fresh outside air not previously circulated, mechanically supplied.

Exhaust Air: Minimum acceptable quantity of air, mechanically extracted from the space to the outside.

The following twin-page matrix on pages 144/145 summarizes the impacts from Building Codes and Industry Standards upon passive/hybrid systems and strategies. The statements of each link may vary according to individual situations, but the information could be helpful for designers to evaluate their solar designs and to identify potential conflicts for compliance with building codes requirements.

# BUILDING CODES AND REGULATIONS

PASSIVE SYSTEM / STRATEGY	IMPACT FROM BUILDING CODE	DAYLIGHTING availability of natural light	VENTILATION supply of fresh air and exhaust air filtration	ENERGY CONSERVATION reduction of heat losses by transmission and ventilation	SOUND INSULATION noise protection and avoidance of internal acoustical bridges	FIRE PROTECTION safety in fire, firestopping, emergency egress
 <b>DIRECT GAIN</b>	<b>1</b>	<ul style="list-style-type: none"> <li>protection against glare for working places is recommended</li> </ul>	<ul style="list-style-type: none"> <li>avoidance of uncomfortable air movement close to the glazing</li> <li>integration of ventilation openings (cross-ventilation)</li> </ul>	<ul style="list-style-type: none"> <li>consideration of minimum heat transmission coefficient</li> <li>requirements upon glazing areas and overall thermal transfer value</li> </ul>	<ul style="list-style-type: none"> <li>cases of high noise emission require specific sound insulation values which may be costly to be realized</li> </ul>	<ul style="list-style-type: none"> <li>special fire-stopping glazing may be required to meet of emergency exit (i.e., multi-story building)</li> <li>safety glass for sloped areas</li> </ul>
 <b>STORAGE WALL</b>	<b>2</b>	<ul style="list-style-type: none"> <li>sufficient window area required for minimum supply of natural light depending on space use</li> </ul>	<ul style="list-style-type: none"> <li>consideration of maximum airflow rates (i.e., 0.2 m/s)</li> <li>provide separate ventilation openings</li> </ul>	<ul style="list-style-type: none"> <li>see 1</li> <li>a single glazed storage wall would probably not meet the requirements; a selective surface is recommended</li> </ul>	<ul style="list-style-type: none"> <li>single glazing cause the same consideration mentioned in 1</li> <li>low sound insulation by convective loop (also for internal acoustical bridges)</li> </ul>	<ul style="list-style-type: none"> <li>avoidance of smoke transfer to neighbouring rooms or dwellings (smoke tightness of shutters)</li> </ul>
 <b>AIR COLLECTOR</b>	<b>3</b>	<ul style="list-style-type: none"> <li>see 2</li> </ul>	<ul style="list-style-type: none"> <li>see 2</li> <li>no disadvantage in cases of closed cycles as hybrid systems</li> </ul>	<ul style="list-style-type: none"> <li>well insulated will meet the requirements easily</li> </ul>	<ul style="list-style-type: none"> <li>see 2, relevant for open systems</li> <li>low sound insulation when the system is semi-open</li> <li>disadvantages of acoustical bridges in multi-story buildings</li> </ul>	<ul style="list-style-type: none"> <li>see 2, relevant for open systems</li> <li>special requirements upon fire resistance of material depending on number of stories (i.e., <math>h &gt; 3</math>)</li> </ul>
 <b>SUNSPACE</b>	<b>4</b>	<ul style="list-style-type: none"> <li>in cases of sloped roofs snow loads may reduce minimum daylighting requirements of adjacent rooms</li> </ul>	<ul style="list-style-type: none"> <li>exhaust air ventilation from parent room through sunspace may not be allowed or requires minimum exchange rates, height, size of opening above floor</li> </ul>	<ul style="list-style-type: none"> <li>see 1</li> <li>buffer space effect may not be accepted by Building Codes</li> <li>if a sunspace is heated it is considered a habitable room (ref. floor area overcharge)</li> </ul>	<ul style="list-style-type: none"> <li>see 1,2,3</li> <li>bad sound insulation when opening doors to adjacent rooms (internal and immissioning sound transfer)</li> </ul>	<ul style="list-style-type: none"> <li>see 2,3</li> <li>a sunspace is not unrestricted, permitted as necessary escape route</li> </ul>
 <b>ZONING</b>	<b>5</b>	<ul style="list-style-type: none"> <li>interior spaces may fall short of natural light requirements when there are limitations of maximum distances from the window</li> </ul>	<ul style="list-style-type: none"> <li>core spaces like kitchen and bathrooms have to guarantee sufficient supply air vents and provision of forced exhaust air ventilation (min. air change rate)</li> </ul>	<ul style="list-style-type: none"> <li>see 4</li> </ul>	<ul style="list-style-type: none"> <li>no disadvantageous consequences</li> </ul>	<ul style="list-style-type: none"> <li>if habitable rooms are allowed to be located in the core at all, providence of smoke detection will likely be mandatory</li> </ul>

Figure 6.12



# BUILDING CODES AND REGULATIONS

STRUCTURAL STABILITY requirements upon building components	PLANNING PERMISSION/ PERMISSION/ APPLICATION	FLOOR AREA OVERCHARGE	SECURITY AND INSURANCE	LOCATION AND ORIENTATION OF ROOMS	SERVICING AND MAINTENANCE
<ul style="list-style-type: none"> <li>• structure and security related demands for sloped glazings above head</li> <li>• water tightness and drainage</li> </ul>	• no impact	• inapplicable	<ul style="list-style-type: none"> <li>• large glazings may also advance the rate of glass insurance because of the increased risk of damage</li> </ul>	<ul style="list-style-type: none"> <li>• living rooms should not face north</li> <li>• difficulties if internal sanitary rooms are not accepted</li> <li>• minimum distance of windows from neighboring apartments</li> </ul>	<ul style="list-style-type: none"> <li>• access for cleaning and servicing for fixed glazing areas may be required for multi-storied buildings</li> </ul>
<ul style="list-style-type: none"> <li>• requirements upon general glazing techniques to avoid breaks by thermal tensions</li> </ul>	• no impact	• inapplicable	• see 1	• no impact	• see 1
• see 2	• no impact	• inapplicable	• see 1	• no impact	• see 1
<ul style="list-style-type: none"> <li>• see 1</li> <li>• structural requirements upon sunspace construction, i.e., upon multi-storied designs</li> </ul>	<ul style="list-style-type: none"> <li>• regional requirements depending on height, area, volume, depth, or space use</li> <li>• request notification or permission</li> </ul>	<ul style="list-style-type: none"> <li>• sunspace floor area may count differently depending on regional codes</li> <li>• different evaluation depending on space use, heated or unheated sunspaces</li> </ul>	• see 1	• see 1	• see 1
• no impact	<ul style="list-style-type: none"> <li>• impact in cases of retrofit related to general building permission</li> </ul>	• see 4	<ul style="list-style-type: none"> <li>• see 1, if large glazing areas are provided</li> </ul>	• see 1	• no impact

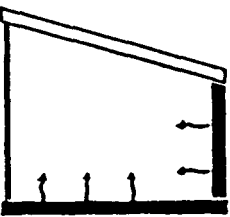
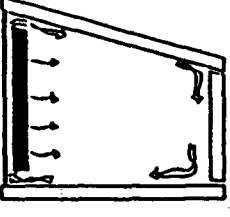
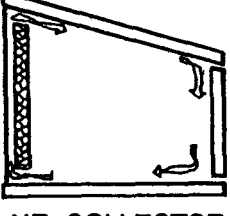
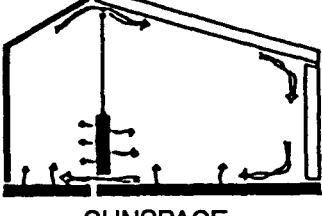
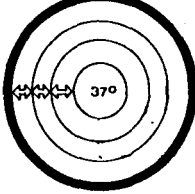
# CONCLUSION

---

## Context of Design Context

Considerations of energy conservation and solar energy use in concert with high thermal comfort conditions are required to increase the living quality and to decrease the living costs in residential buildings.

The issues addressed in this booklet have shown that passive/hybrid solar low energy buildings are not meant to be a new architectural building style developed from a catalogue and transferred to arbitrary climate conditions.

A single recipe for bioclimatic design is neither possible nor desirable. In fact, the opposite should be intended: bioclimatic design considerations offer a positive challenge for designers to realize local, traditional architectural varieties that result in a positive identification of the occupant with his individual residence.

Obviously, the reputation of bioclimatic and energy responsive architecture has changed during the last few years from an exotic and fashionable appearance to a genuine requirement upon building design and construction.

However, there is still a big gap to be filled concerning information and education for all who are involved in architectural building design. Architects, the home builders, prospective and potential clients, and occupants should be trained for environment and energy consciousness. This training is also important for those persons who will set the pre-conditions for promoting or will be authorized to approve or reject bioclimatic and passive/hybrid solar strategies: architectural teachers in high schools and universities, building societies, responsibilities of municipalities, and public authorities.

Bioclimatic architectural design is not a commercial product of industrial manufacturing processes, but the result of intellectual work and creative effort. A lobby for these environmental and energy related concerns can only be born by the people who have already been convinced and those who are seriously interested in the improvement of living and environmental quality.

# REFERENCES

---

	<b>LITERATURE</b>	<b>FIGURES</b>
Lit 1	P. und M. Krusche, D. Althaus, I. Gabriel Hrsg.: Umweltbundesamt: "Ökologisches Bauen" Bauverlag GmbH, Wiesbaden und Berlin, 1982	2, 3, 1.7-1.10, 1.12, 1.15, 1.16, <b>1.32</b> , 1.33, 2.8, 2.24, 2.27, <b>2.36b</b> 2.36c, 2.36d, 2.37, 3.4, 3.6, 3.9, 5.3, 6.6, 6.7,
Lit 2	G. Löhnert, P. Kirch, J. Widjaja: "Klimagerechtes und energiesparendes Planen und Bauen am Beispiel von Geschosswohnungsbauten" Diplomarbeit an der Technischen Universität Berlin, 1979	2.45
Lit 3	G. Löhnert, I. Lütkemeyer: "Solares Forschungsgebäude in Berlin" - Solares Gebäudekonzept für Forschung und Lehre - Technische Universität Berlin, 1984	3.24-3.31, 5.1
Lit 4	G. Löhnert, W. Ehlers: "Sun-Days on Madeira" TU-Berlin, Department of Bioclimatic and Energy-Conscious Design, 1984	
Lit 5	G. Löhnert: "Thermal Insulation and Shading System - TWS" Proceedings of the European Conference on Architecture, Munich, 1987, Commission of the European Communities	
Lit 5	G. Hillmann, J. Nagel, H. Schreck; Mitarbeit G. Löhnert: "Klimagerechte und Energiesparende Architektur" C.F. Müller GmbH, Karlsruhe 1982	1b-d, 1.3, 1.4, 1.13, <b>1.14</b> , 1.43, 2.17, 2.21, 2.36b, 2.38, 2.39, 2.40, 3.23, 3.38, 3.39, 3.40, 3.43, 3.44, 4.18, 5.5
Lit 6	G. Hillmann, N. Nadler: "Passive Sonnenenergienutzung: Wintergarten-Solarwand" Interdisziplinäres Forschungsprojekt 21/5, TU Berlin 1986	3.19, 3.32, 3.33
Lit 7	G. Ludewig: "Klimagerechtes Bauen in warmen, sommertrockenen Gebieten am Beispiel der 'CASA SOLAR PASSIVA' auf Porto Santo, Portugal" Dissertation an der TU Berlin, 1988	3.46-3.49
Lit 8	J.D. Ned Nisson: "Windows and Energy Efficiency" Principles, Practice and Available Products Cahners Publishing Company, Boston, 1984	
Lit 9	P. Steiger, C.U. Brunner, H. Frei, D. A. Gruenberg, H. Bemund, M. Steiger: "PLENAR - Planung Energie Architektur" CH Niderteufen, 1975	2.6, 2.19

## REFERENCES

---

### FIGURES

### LITERATURE

- |   |        |   |
|---|--------|---|
|   | Lit 10 | Bodo Weidlich, Bernd Dittert:<br>Hrsg.: Bundesminister für Forschung und Technologie:<br>"Wärmeschutz - Energieeinsparung - Wirtschaftlichkeit"<br>Verlag TÜV Rheinland GmbH, Köln 1980                     |
| 1.44  | Lit 11 | Hrsg.: Erhard Franke<br>Forschungsgemeinschaft Bauen und Wohnen:<br>"Stadtklima", Karl Krämer Verlag, Stuttgart 1977  |
| 2.12, 2.43, 2.44, 2.46                              | Lit 12 | Hrsg.: J.W. Ludwig (Red.): "solar 4", Architektur und Energie<br>Ausstellung Berlin 1981, Ausstellungskatalog,<br>Archibooks, Berlin 1981   |
| 1.1, 1.5, 1.19 -1.22, 2.18, 2.33,<br>3.7, 3.8, 3.45 | Lit 13 | Commission of the European Communities:<br>"European Passive Solar Handbook"<br>ECSC, EEC, EAC, Brussels and Luxembourg, 1986   |
| 2.32, 2.34  | Lit 14 | Gary O. Robinette, Charles Mc Clenon:<br>"Landscape Planning for Energy Conservation"<br>Van Nostrand Reinhold Company Inc., 1983   |
| 4.9, 4.10, 4.14, 4.15, 4.19                         | Lit 15 | T. Baumgarten, P. Chuard u.a.:<br>"Heizsysteme für Energiesparhäuser"<br>Bundesamt für Konjunkturfragen, CH Bern, März 1987   |
| 3.17  | Lit 16 | Editor: J.D. Ned Nisson:<br>"Energy Design Update"<br>Cahners Publishing Company, 1984  |
| 2.35b   | Lit 17 | Gernot Minke, Gottfried Witter, Christian Balche:<br>"Häuser mit grünem Pelz"<br>Verlag Dieter Fricke GmbH, 1982  |
|   | Lit 18 | Rainer Albrecht, Linda Paker, Siegfried Rehberg,<br>Yvonne Reiner, Hrsg.: Umweltbundesamt:<br>"Umweltentlastung durch ökologische Bau- und Siedlungs-<br>weisen", Bauverlag GmbH, Wiesbaden und Berlin 1984 |
| 2.28, 2.29  | Lit 19 | Donna Ahrens, Tom Ellison, Ray Sterling:<br>"Earth Sheltered Homes", USC University of Minnesota<br>Van Nostrand Reinhold Company, 1981   |
| 3.5   | Lit 20 | Recknagel, Sprenger:<br>Taschenbuch für "Heizung und Klimatechnik"<br>Oldenbourg Verlag GmbH, München, 1988   |
| 4.17, 6.1   | Lit 21 | H. Hebgen:<br>"Bauen mit der Sonne"<br>Energie-Verlag GmbH, Heidelberg 1982   |

## REFERENCES

---

LITERATURE	FIGURES
Lit 22 Schriftenreihe des Bundesministers für Raumordnung, Bauwesen und Städtebau, Bau- und Wohnforschung: "Energetisches Bauen"	6.2
Lit 23 Cziesielski, Daniels, Trümper Hrsg.: Ruhrgas AG Essen: "Ruhrgas Handbuch" Haustechnische Planung Karl Krämer Verlag, Stuttgart	4.2
Lit 24 B. Geiger, B. Wenzel: Forschungsstelle für Energiewirtschaft, München und Prof. Dr.-Ing. H Schäfer: "Heizungen im Vergleich", Neue Presse, Coburg, 1980	4.1
Lit 25 Hrsg.: E. Sälzer und U. Gothe: "Bauphysik Taschenbuch 1986/87" Bauverlag GmbH, Wiesbaden und Berlin 1986	
Lit 26 R.L. Crowther AIA, Solar Group/Architects: "Sun Earth", New York 1977	1 a
Lit 27 Peter v. Eynern: "Mensch und Wetter", Heyne Verlag, München 1975	1.23
Lit 28 V. Olgyay: "Design with Climate" Princeton University Press, Princeton 1963	1.40
Lit 29 S.V. Szokolay: "Environmental Science Handbook for Architects and Builders" The Construction Press, 1980	
Lit 30 H.C. Wohlers, in P.W. Purdom (Hrg.): "Environmental Health" Acad. Press, New York 1971	1.11
Lit 31 Prof. Dr. L. Finke : "Zuordnung und Mischung von bebauten und begrünten Flächen" aus der Schriftenreihe Städtebauliche Forschung des Bundesministers für Raumordnung, Bauwesen und Städtebau, 1974 Studie im Auftrag des BMFT; Statusbericht Rationelle Energieverwendung 1980, TÜV-Verlag Rheinland, Köln 1981	
Lit 32 Staatliche Bauverwaltung Nordrhein-Westfalen: "Planungshilfe Energiesparendes Bauen" Düsseldorf 1979	2.2
Lit 33 J.E. Cermak "Nature of Air Flow around Buildings" complete reference unavailable	

## REFERENCES

---

### FIGURES

### LITERATURE

- 2.1 Lit 34 Arge Prognos, Büro ur, Schmidt-Reuter Ing.-Gesellschaft:  
"Bauvorhaben Erlangen-West: Rationelle Energieverwen-  
dung bei der Planung und Durchführung von Hochbau-  
maßnahmen", Studie im Auftrag des BMFT, 1981
- 2.4 Lit 35 Vladimir Nikolic et. al.:  
"Bau und Energie"  
Studie im Auftrag des BMFT; Statusbericht Rationelle  
Energieverwendung 1980, TÜV-Verlag Rheinland, Köln 1981
- 5.12 Lit 36 David Wright:  
"Natural Solar Architecture"  
Litton Educational Publishing, Inc.,  
published by Van Nostrand Reinhold Company, N.Y., 1978
- Lit 37 M. Jaffe and D. Erly:  
"Protecting Solar Access for Residential Development"  
A Guidebook for Planning Officials, U.S.Dep. of Housing and  
Urban Development, U.S. Government Printing Office,  
Washington D.C. USA 1979
- 2.36a Lit 38 The Royal Architectural Institute of Canada:  
"Energy Conservation - Design Resource Handbook"  
Ottawa 1979
- 3.2, 3.12 Lit 39 Brunner, Conrad U. et. al.:  
"Energiegerechte Neubauten"  
Eidgenössisches Department des Innern/Amt für Bundes-  
bauten, CH Bern 1981
- 6.11 Lit 40 The Ehrenkrantz Group :  
under contract to AIA Research Corporation:  
"Survey of Codes, Regulations and Standards"April, 1978
- 6.10 Lit 41 H.A.L. van Dijk:  
IEA Task XII, Windows and Fenestration, Step 1:  
"Building Regulations, Standards and Codes Concerning  
Thermal and Solar Performance of Windows", Delft, May 86
- Lit 42 B. Givoni:  
"Man, Climate and Architecture"  
Van Nostrand Reinhold Company, New York, 1976
- 2.22 Lit 43 Batelle-Institut: Rationelle Energieverwendung  
im Planungsgebiet Erlangen-West. Im Auftrag des BMFT.  
TÜV-Verlag Rheinland, Köln 1980
- Lit 44 L. Rouvel:  
Wärmegewinne in Wohnungen aufgrund innerer Wärmequellen  
GI 105, 1984, Heft 3, Seite 104-142

## REFERENCES

---

### LITERATURE

- Lit 45 Leistungsprüfung und Planungsmethode für  
Fussbodenheizungen, Impulsprogramm Haustechnik, 1987  
Eidgenössische Drucksachen- und Materialzentrale, Bern
- Lit 46 H. Weber: 2.5, 2.7, 2.9, 2.10, **2.20**, 5.6  
"Energiebewußt Planen"  
Callwey Verlag, München, 1983
- Lit 47 Stiftung Warentest: "Wie dick muß die Dämmung sein?" 3.10, 311  
Energie-Sonderheft Dezember 1980
- Lit 48 Institut für Bauforschung e.V. Hannover : 2.13 , 2.14  
"Energiewirtschaftliche Aspekte zur Planung und Gestaltung von  
Wohngebäuden", Schriftenreihe "Bau- und Wohnforschung" des  
Bundesministers f. Raumordnung, Bauwesen und Städtebau '83  
Energiesparhaus Kassel, Architekten Dietz und Partner
- Lit 49 Hrsg.: Der Bundesminister für Forschung und Technologie: 1.17, 6.4  
"Bauen und Energiesparen" Ein Handbuch zur rationellen  
Energieverwendung im Hochbau für Bauherren, Architekten,  
Ingenieure, Verlag TÜV Rheinland GmbH Köln, 1979
- Lit 50 W. Dickinson and Cheremisinoff:  
"Solar Energy Technology Handbook"  
Part. A, Engineering Fundamentals, Marcel Dekker, 1980
- Lit 51 Armand Dütz, Herbert Märtin: 2.3,2.25, 6.3  
"Energie und Stadtplanung"  
Schmidt Verlag GmbH, Berlin 1982
- Lit 52 Th. Herzog, J. Natterer: 2.49 , 5.11  
"Gebäudehüllen aus Glas und Holz"  
Presses Polytechniques Romandes, Lausanne 1985
- Lit 53 M. Anderlitzky / G. Selle: 1.42a, b  
"Lernbereich Wohnen" Band 2  
Rowolt Taschenbuchverlag Reinbek, 1979
- Lit 54 H . Hebgen:  
"Neuer baulicher Wärmeschutz"  
Vieweg, Braunschweig 1978
- Lit 55 Hrsg.: Aktionsgemeinschaft Glas am Bau:  
"Wohnen auf der Sonnenseite"  
Solar-Architektur in Deutschland
- Lit 56 Arge Sieverts und Volwahren, U.Roth: 6.2  
Rationelle Energieverwendung im Rahmen der kommunalen  
Entwicklungsplanung.  
MFPRS-78.15, Studie um Auftrag des BMBau, Bonn 1980

## REFERENCES

---

### Index for Figure Numbers of Literature:

normal = modified  
*italic* = redrawn  
**bold** = original

### PHOTOGRAPHS:

G. Lepkowski: 3.52

G. Löhnert: 1.0, 1.2, 1.13, 1.14, 1.26, 1.38, 1.39, 1.41,  
1.45, 2.0, 3.0, 3.53, 5.0, 5.13, 5.14

G. Ludewig: 3.47, 6.0

R. Rittelmann: 1.28

W. Rudolf: 1.42 c

Lit. 9: 1.42 a,b

Elpan Aps.: 4.0