

Sustainable Refurbishment

School Buildings



IEA Solar Heating and Cooling Programme

The Solar Heating and Cooling Programme was founded in 1977 as one of the first multilateral technology initiatives ("Implementing Agreements") of the International Energy Agency. Its mission is "to enhance collective knowledge and application of solar heating and cooling through international collaboration to reach the goal set in the vision of solar thermal energy meeting 50% of low temperature heating and cooling demand by 2050.

The member countries of the Programme collaborate on projects (referred to as "Tasks") in the field of research, development, demonstration (RD&D), and test methods for solar thermal energy and solar buildings.

A total of 53 such projects have been initiated to-date, 39 of which have been completed. Research topics include:

- Solar Space Heating and Water Heating (Tasks 14, 19, 26, 44)
- Solar Cooling (Tasks 25, 38, 48, 53)
- Solar Heat or Industrial or Agricultural Processes (Tasks 29, 33, 49)
- Solar District Heating (Tasks 7, 45)
- Solar Buildings/Architecture/Urban Planning (Tasks 8, 11, 12, 13, 20, 22, 23, 28, 37, 40, 41, 47, 51, 52)
- Solar Thermal & PV (Tasks 16, 35)
- Daylighting/Lighting (Tasks 21, 31, 50)
- Materials/Components for Solar Heating and Cooling (Tasks 2, 3, 6, 10, 18, 27, 39)
- Standards, Certification, and Test Methods (Tasks 14, 24, 34, 43)
- Resource Assessment (Tasks 1, 4, 5, 9, 17, 36, 46)
- Storage of Solar Heat (Tasks 7, 32, 42)

In addition to the project work, there are special activities:

- SHC International Conference on Solar Heating and Cooling for Buildings and Industry
- Solar Heat Worldwide – annual statistics publication
- Memorandum of Understanding with solar thermal trade organizations
- Workshops and conferences

Country Members

Australia	Germany	Portugal
Austria	Finland	Singapore
Belgium	France	South Africa
China	Italy	Spain
Canada	Mexico	Sweden
Denmark	Netherlands	Switzerland
European Commission	Norway	United States

Sponsor Members

ECI ECREEE RCREEE

Further information

For up to date information on the IEA SHC work, including many free publications, please visit www.iea-shc.org.

SUSTAINABLE REFURBISHMENT OF SCHOOL BUILDINGS

TABLE OF CONTENT

Contributors

Foreword

0. Introduction	001
0.1. School refurbishment: a challenge, locally and for Europe	003
0.2. School buildings: buildings with special characteristics	003
0.3. Refurbishment of school buildings, two major priorities	006
0.4. Sustainable refurbishment of schools: definition and priorities	007
0.5. Energy regulation and environmental certifications	014
0.6. Conducting a successful school refurbishment project	024
1. Comfort and Quality of life	029
1.1. Concept of comfort	033
1.2. Optimising classrooms comfort - goals to be achieved	039
1.3. Ensuring the thermal comfort of children and teachers in the school	044
1.4. Optimising visual comfort in school building	089
1.5. Optimising acoustic comfort	098
1.6. Ensuring good indoor air quality	110
1.7. School, a place for teaching and learning	124
1.8. Improving the quality-of-life in school	134
1.9. Comfort and quality of life - Breeam assessment method	146
2. Services and energy efficiency	153
2.1. Preamble	157
2.2. Optimising the existing heating system	157
2.3. Optimising the production of sanitary hot water	172
2.4. Heating generation by heat pump in school renovation	174
2.5. Using solar energy for production of sanitary hot water	183
2.6. Optimising the artificial lighting in classrooms	184
2.7. Electricity production through cogeneration systems	201
2.8. Electricity production from renewable sources	203
2.9. Heat recovery from a ventilation system	217
2.10. Preheating / precooling of air by underground heat exchanger	222
2.11. Services and energy efficiency - Breeam assessment method	223

Picture: Sylvie Rouche

3. Reduce resources consumption	227
3.1. Reducing drinking water consumption	231
3.2. Replenishing water resources and reducing rainwater runoff	245
3.3. Controlling consumption of natural resources	253
3.4. Reduce resources consumption - Breeam assessment method	273
4. Reduce waste production	279
4.1. Recycling waste water	281
4.2. Reducing, managing and using construction and demolition waste	297
4.3. Reducing, managing and added value from functional waste	309
4.4. Reduce waste production - Breeam assessment method	312
References	315

Contributors

This handbook is produced from material developed in the course of IEA SHC Programme Task 47 Solar Renovation on Non-Residential Buildings.

Operating agent was Fritjof Salvesen from Norway.

This task brought together around 25 experts from 6 countries. The objectives of this new Task are to develop a solid knowledge base on how to renovate non-residential buildings towards the NZEB standards (Net-Zero Energy Buildings) in a sustainable and cost efficient way and to identify the most important market and policy issues as well as marketing strategies for such renovations..

The task was divided in four subtasks:

- **Subtask A: Advanced Exemplary Projects - Information Collection & Brief Analysis**

Subtask Lead Country: Norway.

Leader: Fritjof Salvesen – Asplan Viak

- **Subtask B: Market and Policy issues and Marketing Strategies**

Subtask Lead : Norway

Lead: Trond Haavik – Segel

- **Subtask C: Assessment of Technical Solutions and Operational Management**

Subtask Lead Country: Germany.

Lead: Doreen Kalz, Fraunhofer-Institut für Solare Energiesysteme ISE

- **Subtask D: Environmental and Health Impact Assessment (school buildings)**

Subtask Lead Country: Belgium.

Lead: Sophie Trachte; Architecture et Climat - UCL

For more information: <http://www.iea-shc.org/task47>

This booklet is produced in Subtask D; Environmental and Health Impact Assessment (school buildings)

Main authors are Sophie Trachte and André Deherde from research team "Architecture et Climat", University of Louvain la Neuve, Belgium

Date published: June 2014

Foreword

This handbook was drafted in the context of an agreement between the SPW – Wallonia and the Catholic University of Louvain la Neuve on sustainable and energy efficient retrofitting of the Walloon school buildings. This handbook is mainly intended for architects and architecture students and also for principals and other school administrative authorities.

At a time when major climate change and aspiration for sustainable economic and social development have become major issues, the objective of this guide is to consider school retrofitting from a holistic point of view by developing guidelines not just in terms of energy performances but also in terms of comfort, quality of life, environmental impact and resource consumption.

Across Europe and worldwide, *infant, primary and secondary schools are essential tools in the construction of tomorrow's society and transmission of democratic values*. Schools are, first and foremost, places for opening up to the world, to the acquisition of knowledge and places for socialisation: three indispensable foundations for becoming a citizen of tomorrow's world, capable of good governance.

This is a fundamental role in our societies. In order to fulfill this role, schools must provide places for training and teaching that are comfortable and of high quality. This is currently not the situation in Europe. *Most school buildings are old, dilapidated and poorly insulated. Heating systems too are old and often cannot be regulated. Ventilation systems, if any, are inefficient. Outdoor spaces and playgrounds are often restricted and of poor quality.*

This lack of comfort has negative and scientifically proven consequences on pupils' concentration and learning. This is why school buildings have an urgent need of fundamental refurbishment.

Moreover, sustainable and cost-efficient refurbishment of school buildings provides a real opportunity for making pupils, teachers and parents aware of energy efficiency as well as comfort and the quality of indoor and outdoor

environments. School buildings, their technical equipment and operation can be used as a showcase for the pupils and their families. A showcase that, once experienced, can influence their attitudes and lead them to behave in a more responsible and public-spirited way.

The entire booklet is richly illustrated with both explanatory diagrams and photographs. The large majority of photos are from visits made in Belgian schools, already partially or totally renovated or having the goal of being renovated.

Many graphs and tables also complete the written text.

This guide provides designers with information and resources needed to retrofit school buildings in a responsible and efficient way.

The main difficulty encountered in drafting this handbook lies in the authors' decision to make the guide applicable to all Europe, from the northern countries to southern Italy. Generally speaking, the authors have taken into account the characteristics of middle European countries: Germany, Austria, Belgium and give details for the northern countries when necessary.

It is up to the architect, the student or the school principal to consider this work as an aid and to integrate the principles it proposes into his/her own approach to design, given the local climate and the standards and/or legislation in force.

The guide is divided into four sections, each corresponding to a priority in energy efficient and sustainable school retrofitting.

The first section "Comfort and Quality of life", which is the largest one, deals with the comfort and the quality of life of teachers and pupils in school buildings. This section goes into various themes, namely:

- improvement of the school envelope performances with the objective to increase thermal, acoustic and visual comfort;
- improvement of the indoor spaces design with the objective to increase indoor air quality, acoustic and visual comfort;
- improvement of outdoor spaces, especially playgrounds.

This section also concerns school's accessibility, pupil's and teacher's mobility and impact of new learning technologies.

The second section "Services and Energy Efficiency" concerns reduction of fossil energy consumption during school building's operation. It goes into the optimization of systems and techniques installed in the school building (heating system, lighting system, ventilation system...) This chapter also goes into the use of renewable energy systems such as photovoltaic panels, heat pumps etc.

The third section "Reduce Resources Consumption" deals with the reduction of water consumption and the rational use of building systems and materials.

The fourth section "Reduce Waste Production" deals with the reduction of waste, namely building/renovation waste, operation waste and waste water.

Each section considered in the guide is presented into different chapters. So the architect can either use the entire guide or look up certain specific information, in view of the progress of his/her project.

It is important to realize that there is no standard way of achieving sustainable school renovation. But priority must be given to energy efficiency and comfort of teaching/learning.

There are many ways to achieve responsible and sustainable school renovation that depend on many parameters: typology of the school buildings, quality of the existing building, type of renovation proposed, budget set aside for the renovation, quality of the context, participation level of schools actors (teachers and pupils)...

It must also be stressed that energy efficient and sustainable renovation is not unaffordable.

The idea is to reach a certain level of performance that is entirely accessible in renovation that will allow for better comfort – both indoor and outdoor – energy savings and reduced environmental impact.

If you think that schools buildings retrofitting is indispensable, dare to aim for sustainable renovation!

We hope that designers will enjoy this guide.

0. INTRODUCTION

0.1.	School refurbishment: a challenge, locally and for Europe	003
0.2.	School buildings: buildings with special characteristics	003
0.3.	Refurbishment of school buildings, two major priorities	006
0.4.	Sustainable refurbishment of schools: definition and priorities	007
0.4.1	The five major principles of the Rio Declaration	007
0.4.2.	Definition of sustainable design of refurbishment project	009
0.4.3.	Sustainable refurbishment priorities	009
0.5.	Energy regulation and environmental certifications	014
0.5.1.	European regulation on energy efficiency	014
0.5.2.	Environmental certifications	014
0.6.	Conducting a successful school refurbishment project	024
0.6.1.	Analysis of the situation, goals to be achieved	024
0.6.2.	Settings goals and defining options	025
0.6.3.	Analysis of constraints and actions to overcome them	026
0.6.4.	Works schedulings	026
0.6.5.	Participation of players in the school: teachers ans pupils	026
0.6.6.	The economic aspect	027

Picture: Sylvie Rouche



0.1. School refurbishment: a challenge, locally and for Europe

Across Europe and worldwide, *infant, primary and secondary schools are essential tools in the construction of tomorrow's society and transmission of democratic values.* Schools are, first and foremost, places for opening up to the world, to the acquisition of knowledge and for socialisation: three indispensable foundations for becoming a citizen of tomorrow's world, capable of good governance.

Through their educational career, through the teaching they receive and the subject matter taught, the child or young person will be taught to have balanced relationships, to be aware of equality between boys and girls, to be mindful of others: their fellow students, adults around them, including the elderly, as well as to be active participants in community life. They will be given knowledge, acquire abilities and skills in various fields.

This is a fundamental role in our societies. In order to fulfil this role, schools must provide places for training and teaching that are comfortable and of high quality. This is not currently the situation in Europe. Most school buildings are old, dilapidated and poorly insulated. Heating systems too are old and often cannot be regulated. Ventilation systems, if any, are inefficient. Outdoor spaces and playgrounds are often restricted and of poor quality.

This lack of comfort has negative and scientifically proven consequences¹ on pupils' concentration and learning.

Moreover, most school buildings were built for front-of-class teaching. However, today, with the development of new teaching methods, a school's teaching space is no longer just the classroom, even if that remains an ideal place for a lecture-type teaching. School buildings must enable teaching to be carried out everywhere within the school: in the library, canteen, laboratories, study rooms, childcare facilities and even in the playground, corridors and halls which, generously set out, become spaces for meeting, discussion and life skills learning.

School buildings, through their high-quality interior and exterior layout, can foster creation of an atmosphere conducive to learning and success and can thus play a role in individual development. *School buildings, thus, need to be the outcome of an educational project that takes into account needs that vary according to the age of the students. School buildings must adapt to today's curricula as well as tomorrow's.*

These various reasons, whether ideological, educational or relating to energy efficiency, mean that school buildings are in urgent need of fundamental rehabilitation. Sustainable and cost-efficient refurbishment of a school or school buildings provides a real opportunity for making pupils, teachers and parents aware of energy efficiency as well as comfort and the quality of indoor and outdoor environments. School buildings, their technical equipment and operation can be used as a showcase for the pupils and their families: a showcase that, once experienced, can influence their attitudes and lead them to behave in a more responsible and public-spirited way.

This refurbishment, if it is to be sustainable, must be carried out:

- according to the contexts of which the building is part;
- having been thought through systematically, in order to reach an optimum solution that can satisfy the various aspects of occupant comfort, while meeting technical, economic, political and social constraints. These various aspects must each be studied in depth and also in combination, in the richness and complexity of their interrelationships;
- integrating the occupants (management, teachers and pupils), their specific needs and active participation into the design and refurbishment processes.

The purpose of these guidelines is to raise the awareness of each designer to the various aspects that must be addressed during refurbishment or rehabilitation of school buildings, while also supporting his or her work. In this way, each teacher and each pupil should be enabled to experience and occupy buildings characterised by high energy efficiency and high-quality indoor and outdoor spaces, which provide excellent teaching and learning conditions.

0.2. School buildings: buildings with special characteristics

School buildings have characteristics very different from administrative or office buildings. If certain characteristics can vary between countries, regions, communes or even between schools, others are common to all schools. However, they will all influence the refurbishment strategies to be adopted.

1 Wargocki, P. and Wyon, D.P. (2006): "Effects of HVAC on Student Performance", *ASHRAE Journal*, October, 22-28; Bakó-Biró, N., Clements-Croome, Z. Kochhar, D.J., Awbi, H.B. and Williams, M. (2012): "Ventilation rates in schools and pupils' performance", *Building and Environment* 48, 215-223

SUSTAINABLE REFURBISHMENT OF SCHOOL BUILDINGS

0. INTRODUCTION



→ Relatively low occupancy rates

School buildings have a relatively low occupancy rate, which is very different from that of other public buildings. They are, most of the time, occupied between four and five days per week, from Monday to Friday, from 8 a.m. till 4 p.m. Some premises, such as the library, canteen, study rooms and childcare rooms have even lower rates of occupation, in the order of a few hours per day. School buildings are used for about 30 weeks or 200 days a year, with relatively long periods during which they are unoccupied and, in general, few activities take place during weekends and evenings, other than partial occupation of sports halls, gyms or some cultural spaces.

→ Relatively high number of occupants

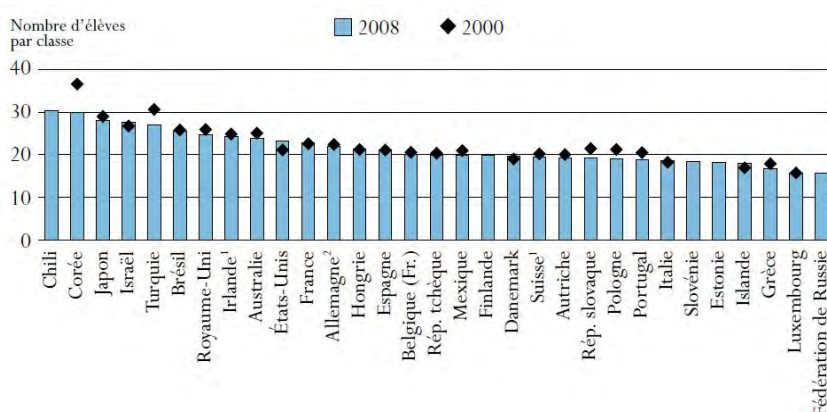

Source: OECD Report «Education at a Glance 2010» – Average class size

Pictures: Sylvie Rouché

A school's population is relatively high, ranging from several hundreds to several thousands of pupils.

While office space, according to European standards, must have an average floor area per occupant of 12 m² to 15 m², each pupil occupies an average floor area of 3 m². Indeed, a classroom has an average floor space of between 50 m² and 80 m². The number of pupils per class varies between 20 and 30. According to the OECD report «Education at a Glance 2010», the average number of pupils per class is 22 in primary education and 24 in secondary education, but there can be major variations between countries (see graph). This equates to an average floor area per occupant of between 2.27 m² and 3.63 m², without taking into account the floor area taken up by furniture.

In view of new teaching guidelines: more diversified, more active and leading to greater mobility of the children in the classroom, one can clearly question the adequacy of classroom size in relation to the style of teaching proposed, and envisage increasing floor area to achieve comfort thresholds.

→ Diversity of occupants and needs

In Belgium, infant schools or kindergartens receive children of various ages between 3 and 6 years. Primary schools receive children of between the ages of 6 and 12 years and secondary schools receive young people between the ages of 12 and 18 to 19 years.

In Norway, school is compulsory from the age of six. Primary schools receive children between the ages of 6 and 12 years, middle schools receive children between the ages of 13 and 15 years and upper schools receive students between the ages of 16 and 18 years.

In Germany, children of between 3 and 6 years are received in kindergartens. Primary schools then receive children between the ages of six or seven and up to 10 years and secondary schools admit young people between the ages of 11 and 19 years.

Needs, whether physical (to move about, create, invent etc.), emotional or educational, will vary according to age-group. School buildings (indoor and outdoor spaces) thus need to be able to adapt to these specific needs and provide the physical framework in the lines, volumes, materials and colours that will both affirm and support the teacher's work².

→ Diverse premises under the same roof, a large floor area to design

Schools house a number of different functions and premises: classrooms, administrative premises, childcare premises, study rooms, sports halls, gyms, canteens, sanitary facilities, libraries, laboratories etc. These premises must meet specific needs and they have varied comfort requirements according to use and activity and at particular times of day:

² Source: Building for children's health – Suzanne Déoux

SUSTAINABLE REFURBISHMENT OF SCHOOL BUILDINGS

0. INTRODUCTION



- Childcare premises are mainly used in the morning before classes begin and at the end of the afternoon, after classes have finished;
- Nursery school children's sleep rooms are used at the beginning of the afternoon;
- Study rooms are mainly used at the end of the day;
- Canteens are used at midday;
- Classrooms are used for relatively long periods of time;
- Gyms or sports halls are used all day, including at midday and sometimes at the end of the afternoon, in the evenings or at weekends.

Construction of these various spaces produces large floor areas and major volumes to design, fit out and operate.



Picture: Catherine Massart



Picture: Catherine Massart



Picture: © Ecole St Joseph Uccle

→ Importance of outside place

Outdoor spaces that relate to the immediate environment of the school, as well as playgrounds or soft landscaped areas are areas of great importance in the life of the school. These are places for meeting and discussion, but also spaces that fill a need for relaxation, recharging one's batteries or exploration. These places give children contact with other children and with nature.

These areas must, therefore, be carefully treated, as they must offer a multiplicity of ambiances and layouts (rest and encounter, relaxation and play) to support children's psycho-motor and social development.

→ Diversity of buildings, methods of construction, materials used

There is no predefined model of a school. Some schools have a very large footprint and are very spread out, with one- or two-storey buildings. Other schools use multi-storey buildings. Yet others operate with a mixture of old and prefabricated «container»-type buildings.

According to the construction period, the construction methods and materials used are different:

- Buildings with heavy masonry facades and structure. The facades, mainly of masonry construction, are punctuated with

Horizontal - Low	Horizontal - High	Centered	Vertical	Mixed
Less than 4 floors Longitudinal extension 1 main vertical access axe Classrooms arranged either on one or both sides of the corridor	More than 4 floors Longitudinal extension More than 1 main vertical access axe Classrooms are arranged either on one or both sides of the corridor	Up to 3-4 floors 2 or more axis horizontally No clear preferential extension Atriums surrounded by the building structures	More than 4 floors Vertical extension-vertical access axes ("core") Classrooms are arranged around this "core"	Composition of elements from previous categories Possibly one dominating category In any case separated treatment necessary
	Contrary to horizontal lower buildings it needs differentiated attention due to fire precaution, escape routes and used materials.		In any case the vertical building category needs differentiated attention due to fire precaution, escape routes and used materials.	



Source: Schoolventcool Report

0. INTRODUCTION



relatively large openings;

- Buildings with load-bearing structural frame (concrete or steel) and non-load-bearing infill facade components;
- Buildings with a load-bearing structural frame and a non-load-bearing facade that completely hides the structural frame;
- Complexes of prefabricated or container buildings.

Some school buildings are listed as partially or totally protected.

→ Age and dilapidation of European school buildings stock

Europe's school building stock is relatively old, often dilapidated and has poor energy performance.

Article 4 of the European Commission's proposal for an Energy Efficiency Directive (June 2011) provides that, from 1 January 2014, 3% of public buildings or buildings belonging to public bodies should be refurbished every year, with the objective of energy efficiency. Currently, the same percentage is refurbished annually, but energy efficiency improvement is only included in a half of those cases (1.5% of the rate of energy-related refurbishment). In this same proposal, the memorandum on schools and kindergartens explicitly mentions that this type of infrastructure should be renovated with a high standard of insulation to the envelope and roof, installing double glazing and replacing inefficient or obsolete heating systems. However, there remains a major problem to be dealt with: the ventilation and air quality of school premises.

0.3. Refurbishment of school buildings, two major priorities

→ Comfort, a factor in children's learning and performance

«Buildings are, first and foremost, constructed to be comfortable and healthy. This is, in fact, their purpose. Buildings must protect their occupants from the outdoor environment and provide pleasant environmental conditions and indoor air quality etc.» Source: Santé et qualité de l'environnement intérieur dans les bâtiments, Claude-Alain Roulet

It is scientifically proven that a comfortable environment, i.e. an environment that provides good natural light, suitable acoustic characteristics, a comfortable temperature, good indoor air quality and well-designed, attractive outdoor space can help pupils learn and assimilate various sorts of subject matter better, and be more effective learners. In many cases, the improvement of these features also leads to reduced energy consumption. This issue must, therefore, be one of the main goals for all school building refurbishment projects, from a social point of view just as much as an environmental or economic one.

This issue requires comprehensive design:

- Improvement of thermal, acoustic, visual and olfactory comfort in the indoor and outdoor spaces of schools;
- Taking health into account through air quality of the premises, water quality, quality of sanitary facilities and layout of equipment that facilitates learning about hygiene;
- Improvement of quality of life and safety;
- Operational improvement, qualities relating to the use, adaptability and ease of building's maintenance;
- Interacting with the immediate environment through sharing some spaces or some functions, by opening up of the school for particular cultural activities etc.;
- Reinforcement of responsible and public-spirited behaviour.

→ Reduction of energy consumption in European schools

Schools and academic buildings (including universities) represent 17% of the European stock of buildings and approximately 12% of average, non-residential, energy consumption in Europe³.

A large part of the operational costs of schools in central Europe and in the Scandinavian countries is taken up by heating the premises and the upkeep and maintenance of buildings.

Simultaneously reducing energy and maintenance costs is, thus, one of the main objectives for all school building refurbishment projects, from both an economic and an environmental point of view:

- Optimising or reducing operating costs;
- Improving asset value;
- Reduction of resource consumption: power, water etc.;
- Reducing environmental impacts such as global warming, pollution of air, water and soil;

3 Source: Europe's buildings under the microscope - A country-by-country review of the energy performance of buildings - http://www.bpie.eu/documents/BPIE/LR_%20CbC_study.pdf



Picture: Catherine Massart



Picture: Catherine Massart



Picture: Sylvie Rouche

0.4. Sustainable refurbishment of schools: definition and priorities

Sustainable design of a refurbishment project involves taking account of, on the one hand, the definition of sustainable development and all its supporting principles and, on the other hand, the environmental and health impacts of the European construction sector.

Sustainable development was defined in 1987 in the Brundtland Report «Our Common Future»:

Development «that meets the needs of the present without compromising the ability of future generations to meet their own needs. It contains within it two key concepts: the concept of 'needs' and, in particular, the essential needs of the world's poor, to which overriding priority should be given; and the idea of limitations imposed by the state of technology and social organisation on the environment's ability to meet present and future needs.»⁴

According to the European Conference on Sustainable Refurbishment of Buildings (2012), the building sector represents 25 billion m² of constructed surface area in Europe. 40% of this stock, which was erected before 1960, requires major refurbishment.

The environmental impacts of the construction sector are substantial:

- 40% of natural resources exploited;
- 40% of total energy consumption;
- 35% of waste produced;
- 40% of greenhouse gas emissions (GWP);
- 15% of water consumption.

If renovating school buildings is, above all, an undertaking based upon improving occupant comfort (teachers and pupils) and on the energy performance of buildings and their equipment, with the goal of ensuring effective learning and energy efficiency, *this undertaking, in order to also be considered sustainable, must be based on the three aspects of sustainable development and be committed to a systematic approach*, as defined by the Rio Declaration (1997) and the 27 principles proposed in application of the definition of sustainable development.

0.4.1 The five major principles of the Rio Declaration

The 1987 Brundtland Report «Our Common Future», was the result of the United Nations' call for the setting up a commission of international experts and for analysis of the degradation of the human environment and natural resources, as well as their social and economic consequences. That Report, having made alarming findings regarding the state of both the global environment and development (social, economic, cultural and political), their interdependence and the «unsustainability» of their development, proposed a new approach to the question of development, calling it «sustainable». Twenty-seven principles defining that idea were established.

Those principles can be summarised by five major concepts:

→ The principle of integration of environmental, social, economic and political aspects

Environmental capital covers the environment, including biological diversity and reserves of both finite and renewable natural resources. Social capital covers health, skills, knowledge, know-how, training, culture, the experience of populations and relationships between members of a society or a group. Economic capital covers financial capital, but also physical or material capital such as technical infrastructure, machines, buildings etc. Political capital covers customs, laws, and the various categories of institutionalised bodies at various levels of power.



Sustainably refurbished school buildings would have all the operational qualities expected of a school building (functionality, comfort, learning performance, energy performance, technical features etc.), but in a manner that minimised their long-term environmental, economic and social impacts:

- *at all levels: from that of the quality and comfort of a school's indoor space, to that of the planet and including the outdoor spaces around school buildings and their relation with the surrounding area;*
- *at all times; from the extraction of the raw materials required for production of materials and building components to the end of their service life; from design of the refurbishment project till the end of the building's service life, including the phases of construction, operational life and maintenance etc.*

→ The principle of inter and intra-generational equity

This principle signifies that we must consider the totality and balance of the four types of capital defined above as a heritage. We had the right to inherit it and, thus, for our generation to enjoy it equitably, but we also have the obligation to transmit it to future generations not just without degrading it, but preferably enriching it.

Sustainable refurbishment of school buildings will take into account today's requirements in terms of liveability, while being able to satisfy those of the future, and will do this without generating any major nuisance for present and future generations. Indeed, teaching methods evolve rapidly. Today's school buildings need to reflect and embody the educational project.

→ Scientific uncertainty and the precautionary principle

"Children are our future and the future of sustainable development begins with safeguarding the health of our children» Kofi Annan, UN Secretary General, 2003

This principle implies the reduction of hypothetical or potential risks. It goes further than the idea of prevention, which is satisfied by limiting proven risks. In other words, it means thinking about the consequences of all our actions; our responsibility is no longer retrospective but forward-looking.

Sustainable refurbishment of school buildings will limit the risks at all levels: that of the health of workers involved in the refurbishment works, that of the users (teachers, pupils and administrative staff), that of the environment (local, regional and global), taking into account the various life cycle phases of school buildings: refurbishment project design, works phase, operational phase, replacement or maintenance phase etc.

This principle is fundamental to school refurbishment insofar as no risk must be taken with regard to the health, well-being, comfort and physical and psychological development of the children, who are more vulnerable to threats from their surroundings.

→ The principle of shared responsibility

This principle affirms our shared responsibility with regard to sustainable development issues, while stating that though this responsibility is shared, it is nonetheless differentiated: the Western countries have a greater responsibility with regard to the deterioration of environmental and social capital and they have the economic and political capital best able to reverse those trends.

Sustainable refurbishment of school buildings will take into account the four aspects mentioned above, taking account of current and future needs and applying these to the various phases of the project (design, construction, operation and end of service life).

Responsible designers are designers who will also limit the impacts of their project, both at the immediate environmental level (biodiversity, water resources etc.), and at the general environmental level (energy consumption, location, emission of pollutants etc.).

This idea must also be taken into consideration in the use, upkeep and maintenance of school buildings. From this, flows the importance of raising awareness, informing and providing the tools to enable sustainable management of school buildings by the various players in the school.

→ The principle of participation

The participation of citizens brings decisions (back) to the local level, where they thus become actors. It facilitates taking local conditions into account, allows the taking ownership of choices that become shared and assures a plurality of solutions and points of view.

Sustainable refurbishment of school buildings cannot work without the awareness and active participation of its occupants: teachers, parents and pupils. This principle is fundamental to school refurbishment.

0.4.2 Definition of sustainable design of a refurbishment project

Sustainable design of a refurbishment project entails attention to the contexts within which the buildings are located, in order to enrich or protect both the building and its environment through a variety of interrelationships. This type of design will cause the building or buildings subject to refurbishment to:

→ **be enriched by the opportunities offered by all the contexts within which it is located (social, environmental and economic)**

This involves the contexts of climate (orientation, solar gain, ventilation, shading etc.); geology (land, soils, altitude etc.), hydrology (resources, treatment, distribution, conservation etc.), plants (trees, crops etc.), institutions (ways of living together), infrastructure (utilities etc.), technology (technologies, materials etc.), policy (social mix, operational mix etc.) and heritage (buildings, landscapes etc.).

→ **be protected against local threats**

This involves protection from cold, heat, rain, noise, pollution and flood risk, but also from insecurity, lack of drinking water, serving only a single generation or a single function, lack of public transport, harmful materials etc.

→ **enrich its environment with sustainable improvements**

Constructing a building which, if it must be removed, will not have caused any detriment to its environment, is not sufficient for a sustainable building. Thus, the architecture must locate itself within a triple perspective: the past it inherits, the present it constructs and the future it transmits.

→ **protect the immediate environment from nuisance it may cause**

This involves atmospheric and hydrological pollution connected with manufacture of component materials, production of waste (domestic, demolition etc.), noise nuisance etc., additional traffic, soil sealing etc.

0.4.3 Sustainable refurbishment priorities

The first goal of the process of sustainable refurbishment is to prolong the service life of an existing building, to give it a second lease of life by increasing, on the one hand, its functionality and operational quality and, on the other hand, the comfort and quality of life of its occupants, while limiting the environmental impact of the building and of its operation. Economic viability must also be taken into account. This goal must be implemented taking account of the entire building's life cycle (design, construction, use):



→ **Increasing well-being, comfort and quality of life (social aspect);**

- Increasing thermal, acoustic and visual comfort;
- Enhancing air quality;
- Enhancing the quality of outdoor spaces and landscaped areas whether within the school or adjoining public areas;



- Enhancing the building's functionality and quality of use increasing its adaptability and ease of maintenance;
- Strengthening interactions between the school and its environment.

→ **Enriching stocks of natural resources (environmental and economic aspects)**

- Rationalising consumption of fossil fuels by working on the energy efficiency of buildings and promoting use of renewable energies;
- Sustainably enriching water resources by reducing water consumption and allowing rainwater infiltration into the ground;
- Enriching land and materials resources by limiting land use, by rationalising the use of materials and strengthening biodiversity.

→ **Reducing waste production (environmental and economic aspects)**

- Limiting emissions and air, water and ground pollution;
- Limiting construction waste production by recycling construction waste and using stocks of secondary resources produced by recycling that waste;
- Limiting and managing production of domestic waste.

0.4.3.1. Enhancing well-being, comfort and quality of life

Refurbishment of school buildings is often made necessary by their dilapidated or unsanitary condition, which gives rise to a general lack of comfort. Refurbishment is, thus, an opportunity to improve the liveability of the building, the comfort of its indoor and/or outdoor space at the same time as its energy efficiency.

Enhancing the comfort of indoor space means improving, simultaneously, the occupants' thermal comfort (in both summer and winter), and their acoustic, atmospheric and visual comfort.

Atmospheric comfort and indoor air quality is a major concern with regard to health, quality of life and also efficient learning and performance. The great majority of the school's occupants are children (on average 22 to 24 pupils per class across Europe). They should not be thought of as «small adults» insofar as their metabolism is not yet mature. Children are more vulnerable to threats from their surroundings. These surroundings have a considerable influence upon their psychological and physical development.

Enhancing the comfort of outdoor areas means improving operational quality of playgrounds and soft landscaped areas in and around the school by arranging them in a varied way (different types of space for different activities), by planting, by enriching biodiversity and by taking into account the children's ages and their specific needs.

School buildings, during the refurbishment works phase and/or the operational phase, can be a source of discomfort (major sources of noise or pollution, increased traffic and parking, loss of sunlight etc.), but also of enrichment (new local shops, new shared cultural, social or sporting facilities, new landscaped areas, visual improvement to adjacent areas etc.).

Refurbishment of a school will, thus, noticeably change the life of the occupants, but can also change the environment and context of daily life for all close neighbours.

To be sustainable, the refurbishment process must, thus, also be the opportunity for improving the quality of life linked to the school's immediate environment (social, environmental– built and unbuilt – economic). Therefore, every project owner or designer, conscious of their responsibility for the lasting changes that their refurbishment project will cause to an existing environment, may wish to go further than is required by current planning regulations

It is also important for a sustainable refurbishment project for school buildings:

- to see to what extent particular spaces can be opened up, shared and/or interact with the urban environment or particular urban activities (day and evening courses, sharing of particular sports areas at weekends etc.);
- to recreate safe routes, enabling «soft mobility» for children and parents between home and school, so as to decrease traffic around the school and the nuisances caused by it.

Quality of life and comfort within a school also go hand-in-hand with quality of learning. This quality of learning can be promoted, on the one hand, by attending to comfort in general (suitability of temperature for the children, regulated acoustic ambience, visual comfort etc.) and, on the other hand, by making buildings suitable for the educational project of the school (the building becomes a reflection of the teaching style). This issue will not really be dealt with in the guidelines, because it needs to be considered with the teaching staff of each school. However, approaches for considering the use of buildings will, nonetheless, be suggested.

SUSTAINABLE REFURBISHMENT OF SCHOOL BUILDINGS

0. INTRODUCTION

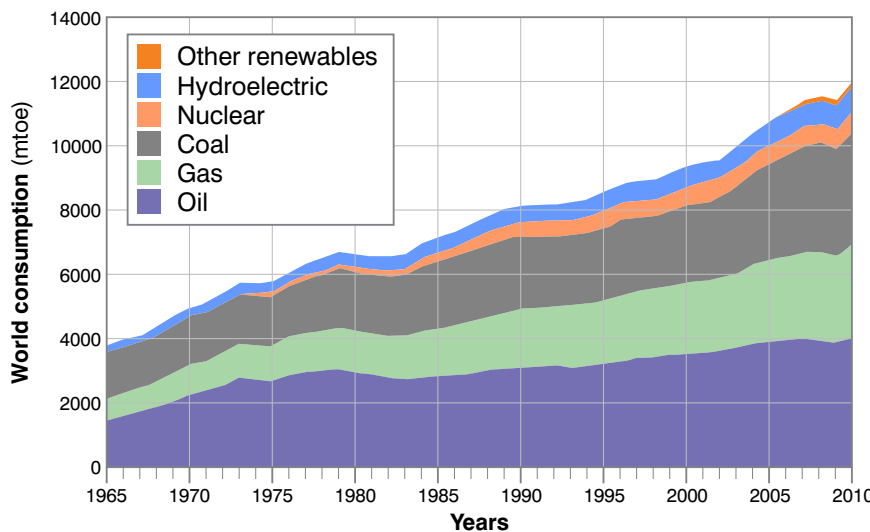

World primary energy consumption by energy type
Source: BP Statistical Review of World Energy, 06/2011

0.4.3.2. Enriching stocks of natural resources

→ Rationalising consumption of fossil fuels by working on the energy efficiency of buildings and promoting use of renewable energies

In a world where demographic and economic growth drive up energy needs and where greenhouse gas emissions, caused by these constantly growing needs, are leading to global climate change, the issue of energy becomes crucial. Expansion of needs raises the question of supply security and climate change raises that of sustainability of the energy system.

Historically, world energy demand has experienced sustained growth over the last 40 years, growing from nearly 5000 mtoe in 1970, to 12,000 mtoe in 2010. It has grown by a factor of more than 2.4 in 40 years, corresponding to an average annual rate of growth in the order of 2.24%. This trend, if it continues for the next 40 years, will lead to world energy demand doubling between 2010 and 2050.

In 2010, more than 80% of world primary energy demand was met by fossil fuels. Oil is the major source of energy, providing 33% of world need, followed by coal (27%) and gas (21%). Renewable energies, for their part, meet 13% of demand, of which, 10% is accounted for by hydropower. The share of nuclear power in primary energy consumption is 6%.

In the light of current energy consumption, our reserves of traditional primary energy sources will be used up in less than a century. Doubtless, there are still currently unknown reserves, but the practical and financial means required to be implemented to find and exploit them will be colossal. This overconsumption of fossil fuels also has disastrous consequences for our environment, particularly in terms of CO₂ emissions, fine particles and other atmospheric pollutants, as well as for the health of living people (fatigue, respiratory and cardiovascular problems, increase in allergies and increased mortality), on the viability of flora and fauna (biodiversity) and on our ancient built heritage.

It is, thus, urgent to consume **LESS, BETTER AND DIFFERENTLY** by applying the following principles:

- radically reducing our consumption of fossil fuel energy by, simultaneously, taking into account energy needed for buildings' operation (buildings' energy efficiency), grey energy of construction materials (environmental audit) and transport energy of the occupants (soft mobility, journeys chart);
- favouring the use of renewable energies when and where possible;
- favouring public transport and soft mobility.

→ Sustainably enriching water resources by reducing water consumption and allowing rainwater infiltration into the ground

Concern for sustainable management of water resources in the building sector is linked to two major issues. On the one hand, massive use of drinking water, the pressure exerted by this overconsumption on water resources and the creation of various forms of pollution that require more and more costly treatment and, on the other hand, urban expansion and soil sealing, which causes overloading of utilities and increased flood risks, and which prevents groundwater renewal. Fresh water is an indispensable commodity for the survival of all ecosystems on Earth. This precious commodity is, however, not inexhaustible: while 70% of the Earth's surface is covered by water, only 3% of that quantity is fresh water and only 0.26% of that is directly available for human consumption.



This resource is also unequally distributed on the Earth's surface.

During the past 50 years, the quantity of fresh water available on Earth has reduced by half and many countries or regions have fallen below the water stress threshold (2,000 m³ per person per year). In fact, our consumption of this precious commodity is practically unrestrained, since the daily consumption per person of drinking water varies from 25 litres (developing countries) to 150 litres (Europe) and 360 litres (USA).

It should also be noted that the quality of our groundwater is becoming poorer and poorer and that treatment to make this water fit for consumption involves increasingly onerous and costly procedures.

Paradoxically, given these three initial findings, it is estimated that only 45% of our daily needs really require drinking water.

*It thus becomes urgent to conserve this fragile resource by consuming **LESS, BETTER, AND DIFFERENTLY**, i.e.*

- *by decreasing our consumption of drinking water;*
- *by using rainwater for needs that do not require drinking water.*

Worldwide, increasing urbanisation, increasing density of built-up areas and the increase of impermeable surfaces have the consequence of modifying, even destroying the **BALANCE** between built-up areas and non-built-up areas, with major effects on rainwater management. Indeed, the increase in impermeable surface (essentially in heavily urbanised areas) causes a major increase in the flow rate of water directed to the public sewer network. This has the consequence of rapidly saturating existing utilities and causing flood risk, of increasing the volume of water to be treated and of increasing costs in connection with sewerage and water treatment.

Moreover, the reduction of green areas and permeable surfaces leads to a major reduction in groundwater replenishment. Greater and greater urbanisation and large-scale industry and agriculture caused by our mode of consumption also entail increased pollution of our fresh water reserves.

Global catastrophes – floods, rivers breaking their banks, drought, and water shortages – *prove that it is becoming urgent to **RESTORE** that indispensable balance for the good operation of the water cycle in cities and heavily urbanised areas.*

To restore that balance, every designer and every project owner can take simple and effective measures for good rainwater management on the plot of the building to be refurbished. In particular, this means:

- *increasing the permeability ratio of the plot;*
- *providing the plot with storage and soakaway provision;*
- *selecting water-permeable exterior ground surfaces;*
- *treating wastewater, reusing it or allowing it to percolate into the ground;*

→ **Long-term enrichment of land and material resources by limiting land use and strengthening biodiversity**

With regard to land and land use, we face two phenomena:

Greater and greater urbanisation of towns and cities, resulting in increasing density of built-up areas, increase and congestion of road traffic, declining social relations, lack of green areas and biodiversity, soil sealing etc.;

The urban exodus with populations moving to the urban peripheries and to the countryside, on the pretext of seeking a better quality of life and relationship with nature, and its consequent waste of land and greenfield sites, spread of utilities, overconsumption of energy and general pollution.

Each of these two opposed phenomena has serious consequences for the environment, society and culture as well as for the local and global economy.

The concept of land is connected to both the exploitation of resources and to landscape. In resource terms, the European construction sector uses 50% of total natural resources exploited. In 2005, all sectors combined consumed 58 billion tonnes of extracted resources and a consumption of 100 billion tonnes is forecast for 2030, i.e. an increase of 75% in 25 years⁵. In Europe today, each person consumes, on average, 45 kg of resources per day.

Resources consumed are, for the most part, either renewable materials (mainly natural plant materials that renew themselves more or less rapidly) or non-renewable materials (aggregates, stony materials, petrochemical materials etc., which have taken tens of millions of years to form underground).

Exploitation of these resources, on the one hand, can have damaging environmental consequences (landscape quality, loss of biodiversity, loss of existing ecosystems etc.) and, on the other hand, can have disastrous social consequences: exploitation of children, unregistered workers, workers without Social Security cover, wages too low for a decent standard of living etc.

*It thus becomes **urgent to protect our virgin land, our ecosystems, our resources and landscapes by working simultaneously for:***



- A compact city concept: increasing the density of cities and built-up areas, increasing the density of public transport networks; encouraging social and functional diversity, so as to limit journeys and social segregation and to make use of public space and green areas;
- A compact building concept, for both refurbishment and new construction;
- A responsible choice of construction materials:
 - Selecting materials produced from natural raw materials, raw materials from recycling or renewables with a high rate of renewal, raw materials with an adequate and/or unlimited supply.
 - Selecting materials produced from raw materials whose extraction or exploitation does not cause any or only slight damage to the landscape, ecosystems and general environment.
 - Selecting materials whose exploitation does not harm people.

0.4.3.3. Reducing waste production

→ Limiting construction waste or accumulating stocks of secondary resources

While most of us agree about the impoverishment of both raw materials and energy resources, the construction sector is currently not only a major consumer of both energy and raw materials, but also, and most importantly, a major producer of waste (40% of total waste production).

Because of population growth, the growth of cities and, above all, the growing prevalence of demolition and refurbishment sites in the major European cities, following the frantic construction of the 1960s and 70s, it is expected that the quantity of demolition and construction waste will drastically increase in the coming years. But, worse still, most of this waste, in spite of a real recycling potential, is, due to lack of infrastructure, information or suitable legislation, treated in the traditional ways, i.e. sent to a waste disposal facility or an incineration centre.

These traditional ways cause major damage both on the environmental level and to human health. However, they are increasingly regulated, monitored and costly and there are fewer and fewer such sites in Europe.

Given these two findings, only three alternatives remain for sustainable development:

- Minimising the production of waste – even producing none at all;
- Sorting more waste and doing so at source, so that it can be recovered through recycling facilities;
- Using more recycled materials.

Minimising production of waste entails major preventive work in drawing up the refurbishment project – both in the actual design of the project and in the construction process used and choice of materials.

Sorting more waste and doing so at source entails major work at the building demolition stage and at the level of waste management.

→ Limiting domestic and operational waste

Average waste production for a Brussels primary school amounts to 35 kg per pupil per year. At the Regional level, this makes a total of 3,100 tonnes per year. Each secondary pupil produces 11.2 kg of miscellaneous waste per year (not including food waste). Based on the number of 85,000 secondary pupils in the Region, total miscellaneous waste production (not including food waste) is estimated at more than 950 tonnes per year. Source: www.ibgebim.be

Analysis of school rubbish bins shows that their contents consist, for the most part, of food waste: remains of meals, snacks, drinks either started or not (5% of cartons recovered from dustbins were unopened), drinks packages and papers including nearly 30% of advertising matter. Some waste, smaller in quantity, can also cause problems and require particular attention: printer ink cartridges, paint, glue, laboratory waste and products etc.

However, a few simple actions would suffice to reduce the volume of school waste. If a school produces less waste it also costs less to operate.

In spite of increased sorting, a large part of this mountain of waste is still incinerated. This results in high management costs for the public and a not inconsiderable impact on the environment.

Given these two findings, only two alternatives remain with regard to sustainable development:

- Minimising the production of waste – even producing none at all;
- Sorting more waste and doing so at source, so that it can be recovered through recycling facilities;

Minimising waste production involves each member of the public becoming aware of their lifestyle and consumption – the designer of a refurbishment project has no influence on this.

Sorting more waste and doing so at source requires the designer to set up, during the refurbishment, facilities and means to encourage each occupant to sort their waste.

0. INTRODUCTION



0.5. Energy regulation and environmental certifications

0.5.1 European regulation on energy efficiency

Following European undertakings in the light of the Kyoto Protocol, the European Union Parliament and Council adopted, in 2002, The European Directive (2002/91/CE) on energy performance and indoor climatic conditions of buildings. This Directive assesses the energy performance of buildings such as:

«The amount of energy actually consumed or estimated to meet the different needs associated with a standardised use of the building, which may include, inter alia, heating, hot water heating, cooling, ventilation and lighting for non-residential buildings). This amount shall be reflected in one or more numeric indicators which have been calculated, taking into account insulation, technical and installation characteristics, design and positioning in relation to climatic aspects, solar exposure and influence of neighbouring structures, own-energy generation⁶ and other factors, including indoor climate, that influence the energy demand.»

The Directive requires each member state to define in local or regional law:

- A calculation method for energy performance of buildings;
- Minimum requirements with regard to the energy performance of new buildings and existing buildings subject to major refurbishment;
- Certification schemes for building energy performance;
- Requirements with regard to regular inspection of boilers and air conditioning systems.

In compliance with the Directive, an energy performance certificate must also be issued at each key point of a building's life cycle: construction, sale and rental.

The period of validity of the certificate is 10 years and it must be displayed in public buildings.

0.5.2 Environmental certifications

The 1987 definition of Sustainable Development and the 1992 Rio Earth Summit stressed the fundamental role of construction in terms of environmental footprint. The European Union considers the construction sector to be one of the sectors with the greatest potential for improvement with regard to emissions of greenhouse gases and resource consumption.

The construction sector has thus undertaken to limit its impacts and the past 15 years have seen the emergence and development of various environmental certification schemes. These have the goal of clarifying and objectifying environmental performance levels achieved by buildings.

These various certification schemes are based on reference systems made up of several themes that allow evaluation of a project (for a building, building complex or district).

The principal environmental certification schemes (within and outside Europe) are summarised below. These are:

- BREEAM certification (UK)
- LEED certification (US)
- DGNB certification (GER)
- TOTAL QUALITY BUILDING certification (AT)
- GREENSTAR certification (AUS)
- VALIDEO certification (BE)

For the purposes of the criteria used in this publication, we have based our thinking on the BREEAM certification.

6 *Own-energy generation here means production of energy by system such as thermal solar panels, photovoltaic cells, cogeneration systems etc.*

SUSTAINABLE REFURBISHMENT OF SCHOOL BUILDINGS

0. INTRODUCTION



→ **BREEAM (BRE Environmental Assessment Method)** - <http://www.breeam.org>

breeam

Country of origin: UK
Initiated: 1990
Responsible organisation: BRE GLOBAL (Building Research Establishment)

BREEAM certification is the oldest environmental certification for buildings and the most widely used in the world. Certification is obtained on the basis of an assessment carried out by a licensed assessor or auditor. The assessment is based upon scores awarded according to a set of performance criteria. The nine principal criteria are: management, health and well-being, energy, transport, water consumption, materials, land use, ecology of the site and pollution. The methodological contents are updated every year.

This certification assesses:

- The various stages of construction, from design (provisional certificate) through to building management after construction (final certificate);
- Nine types of buildings (different and specific benchmarks for each type): offices, housing, industrial, prisons, retail, multi-residential, education, courts and health care;
- New buildings or buildings undergoing refurbishment, extension or interior refitting out of existing buildings.

The issues analysed by BREEAM certification as well as the scoring system and weighting used for each issue are as follows:

- Management: 10 points / 0.12
- Health and Well-being: 14 points / 0.15
- Energy: 21 points / 0.19
- Transport: 10 points / 0.08
- Water: 6 points / 0.06
- Materials: 12 points / 0.125
- Waste: 7 points / 0.075
- Land use and ecology: 10 points / 0.10

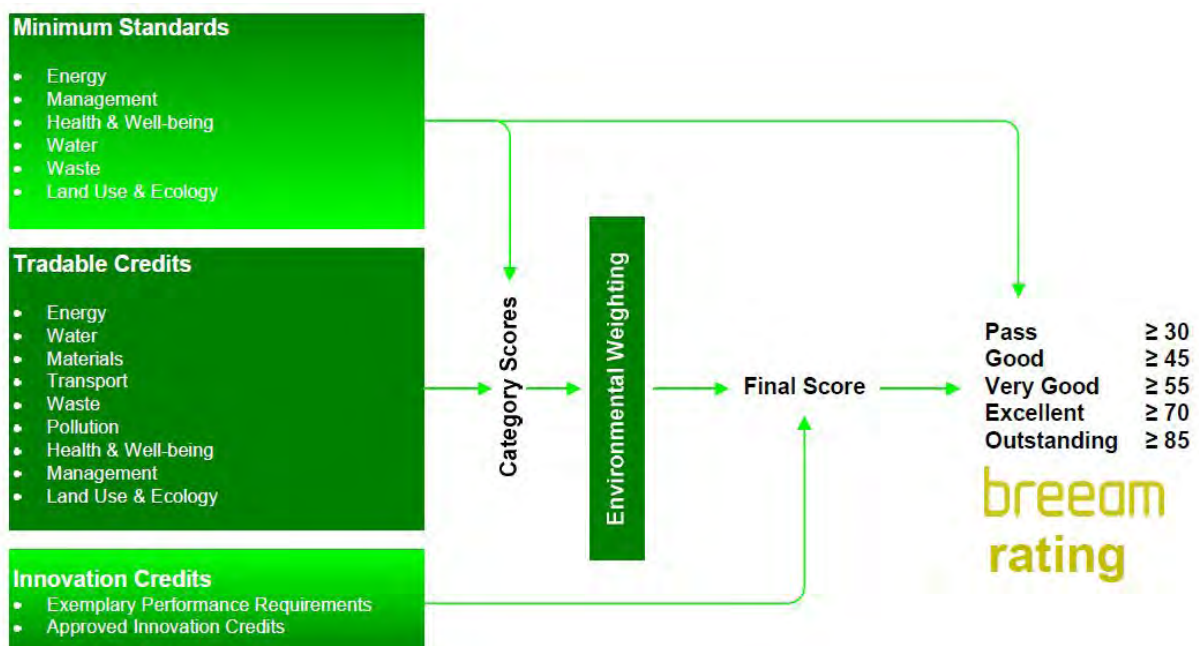

SUSTAINABLE REFURBISHMENT OF SCHOOL BUILDINGS

0. INTRODUCTION



- Pollution: 10 points / 0.12
- Innovations (BONUS): 10 points / 0.10

The scheme offers **five rating benchmarks**:

- Outstanding: > 85%
- Excellent: 70%
- Very good: 55%
- Good: 45%
- Pass: > 30%

The rating system is as follows:

- Award, by the assessor, of points for each criterion;
- Conversion of the points obtained, by issue, into percentages;
- Weighting by a coefficient and adding the percentages for each issue;
- Final score from a maximum 100%.

It is important to stress that certain criteria are mandatory to achieve a particular benchmark level: 14 mandatory criteria for the Outstanding level, two of which are for the issue of Health and Well-being.

SUSTAINABLE REFURBISHMENT OF SCHOOL BUILDINGS

0. INTRODUCTION



→ LEED (Leadership Energy Environment Design) - <http://www.usgbc.org/leed>



Country of origin: United States

Initiated: 1998

Responsible organisation: US Green Building Council (a body created in 1993 and made up of architects and industry, with participation by estate agents and owners).

Certification is obtained on the basis of an assessment carried out by a LEED professional approved by the Green Building Council.

This certification assesses:

- The building at design and/or after construction works, just before occupation;
- Service sector buildings (offices, school buildings, health care establishments, libraries, museums, churches etc.) and residential buildings comprising more than four dwellings;
- Buildings that are newly constructed or that have undergone major transformation/refurbishment.

The categories assessed by the LEED scheme as well as the number of points that can be obtained per category are as follows:

- Sustainable Sites 21 points
- Water Efficiency 11 points
- Energy and Atmosphere 37 points
- Materials and Resources 14 points
- Indoor Environmental Quality 17 points
- Innovation in Design (BONUS) 6 points
- Regional Priority (BONUS) 4 points

The certification offers four levels of scoring, according to the number of points obtained:

- Platinum: > 80
- Gold: 60 to 79
- Silver: 50 to 59
- Certified: 40 to 49

The scoring system is simple: award of one point (or credit) per requirement attained, no weighting between categories. The maximum score is 110 points (100 + 10 points bonus). There are two types of requirement: prerequisites and credits. All prerequisites must be achieved, minimum points to be obtained for credits.

SUSTAINABLE REFURBISHMENT OF SCHOOL BUILDINGS

0. INTRODUCTION



→ **DGNB (German Sustainable Building Certificate)** - <http://www.dgnb.de>



DGNB

Deutsche Gesellschaft für Nachhaltiges Bauen e.V.
German Sustainable Building Council

Country of origin:	Germany
Initiated:	2008
Responsible organisation:	DGNB (Deutsche Gesellschaft für Nachhaltiges Bauen – body created in June 2007 in collaboration with the Ministry of Transport, Construction and Urban Development)

Certification is obtained on the basis of an assessment carried out by a DGNB approved auditor.

This certification scheme assesses buildings and districts from conception (pre-certification) and/or after construction works, just before occupation (compliance testing and certification), for new construction or refurbishment. It provides for objective description and assessment of non-residential and residential buildings. The DGNB certification quality sections cover all the essential aspects of sustainable construction: ecology, economy, socio-cultural aspects, technology, process workflows and sites. These quality sections are assessed on the whole life cycle of the building with a major focus on the comfort and well-being of the occupant. The first four quality sections have an equal weighting in the assessment:

- Environmental quality
- Economic quality
- Socio-cultural and Functional quality
- Technical quality
- Process quality
- Site quality (separate assessment)

The quality sections as a whole cover approximately 60 criteria (<http://www.dgnb-system.de/en/system/criteria>).

Specific criteria are applied for certifying urban districts, such as climate change (wind, humidity etc.) affecting the district, biodiversity and interaction, social and functional diversity etc.

The scheme offers three levels of award:

- Gold: > 89%
- Silver: > 65%
- Bronze: > 50%

The scoring system is as follows:

- Award of points for each criterion: Maximum of 10 points per criterion;
- Application of a weighting factor (from 0 to 3) to the number of points obtained according to relevance;
- Results are expressed as a percentage or graphically.

Site quality is considered separately and this aspect is included in the marketability criterion. In the case of certification of a district, site quality is incorporated in all criteria.

SUSTAINABLE REFURBISHMENT OF SCHOOL BUILDINGS

0. INTRODUCTION



→ **TOTAL QUALITY BUILDING (Austrian Sustainable Building Council)** - https://www.oegnb.net/zertifizierte_projekte.htm



Country of origin:

Austria

Initiated:

2002

Responsible organisation:

ÖGNB (The Austrian Sustainable Building Council, founded on the initiative of the Austrian Institute for Healthy and Ecological Building (IBO) and the Austrian Institute of Ecology (ÖÖI))

TQ (Total Quality, the predecessoring model) was developed in 2001 with subsidies from the Austrian Federal Government as result of international research co-operation in the framework of GBC (Green Building Challenge).

In 2010 the TQB system was aligned with international trends and harmonised with other Austrian building assessment systems (namely IBO ÖKOPASS and klima:aktiv haus). The adapted assessment system was launched by ÖGNB (Austrian Sustainable Building Council), a non-profit organization founded to contribute to widespread implementation of knowledge on sustainable construction

Certification is obtained on the basis of an assessment carried out by an ASBC auditor. This certification assesses:

- The building at design, construction and operation stages;
- Non-residential buildings (offices, school buildings, health care establishments, industrial and retail buildings etc.) and residential buildings (individual houses and multi-residential buildings);
- Newly constructed or refurbished buildings.

The categories assessed by the TOTAL QUALITY BUILDING scheme as well as the number of points that can be obtained per category are as follows:

- Site layout and equipment: 200 points
- Technical and economic qualities: 200 points
- Energy and utilities: 200 points
- Health and comfort: 200 points, including
 - Thermal comfort 50 points
 - Air quality 50 points
 - Acoustic comfort 50 points
 - Natural light 50 points
- Conservation of resources 200 points

The scoring system awards points for each requirement. A maximum of 1000 points can be obtained.

SUSTAINABLE REFURBISHMENT OF SCHOOL BUILDINGS

0. INTRODUCTION



→ **GREENSTAR (Green Building Council of Australia)**



Country of origin: *Australia*
Initiated: *2002*
Responsible organisation: *GREEN BUILDING COUNCIL OF AUSTRALIA (organisation created in 2002 with the support of government and industry, member of the World Green Building Council)*

Certification is obtained on the basis of an assessment carried out by an approved professional. This certification assesses:

- The building at design and construction phases;
- Non-residential buildings (offices, school buildings, health care establishments, industrial and retail buildings etc.) and residential buildings (multi-residential buildings);
- Newly constructed or refurbished buildings.

The issues assessed by the GREENSTAR certification scheme as well as the number of points that can be obtained and the weighting factor for non-residential buildings by issue are as follows:

• Management	12 points / 0.1
• Indoor Environmental Quality	27 points / 0.2
• Energy:	29 points / 0.25
• Transport:	11 points / 0.1
• Water	12 points / 0.1
• Materials:	22 points / 0.1
• Land use and ecology	8 points / 0.1
• Emissions	19 points / 0.05
• Innovations (BONUS)	5 points

The scheme offers six levels of award, shown as numbers of stars. A certificate is only awarded for four stars and above.

• 6 stars:	> 75 points
• 5 stars:	60 – 74 points
• 4 stars:	45 – 59 points
• 3 stars:	30 – 44 points
• 2 stars:	20 – 29 points
• 1 stars:	10 – 19 points

The scoring system is as follows:

- Award of points for each criterion;
- Calculation of score obtained as a percentage for each issue;
- A weighting factor is applied to each percentage score;
- Sum of weighted scores;
- Addition of points gained for innovation (maximum 5 points).

SUSTAINABLE REFURBISHMENT OF SCHOOL BUILDINGS

0. INTRODUCTION



→ **VALIDEO** - www.valideo.org



Country of origin: Belgium
Initiated: 2002 (latest checklist: 2010)
Responsible organisation: Valideo is a collaboration of researchers and engineers from BBRI and SECO, through financial support IRSIB. Analysis and certification are carried out by a certification body. The certification procedure is managed by BCCA

Certification is obtained on the basis of an inspection (before construction and after completion of works) by the Belgian Construction Certification Association (BCCA). This certification assesses:

- The building at the design, construction and, at the end of construction works, handover stages;
- Non-residential buildings (offices, school buildings, health care establishments, retail buildings etc.) and residential buildings (multi-residential buildings);
- Newly constructed or refurbished buildings.

Sixteen different categories are grouped into four themes. The requirements of each theme are modified according to the type of project:

- Site and construction
 - Integration of the project and valorisation on site;
 - Construction stage: management of noise, visual, waste and traffic nuisances;
 - Materials and products: environmental impact of products, rational use and health;
 - Adaptability: flexibility and use, possibility of change or transformation.
- Management:
 - Energy: limiting requirements, optimising systems, use of renewable energies;
 - Water: Limiting requirements, rainwater management, wastewater treatment;
 - Maintenance: taking account of a program for upkeep and maintenance;
 - Waste during exploitation: limiting quantity, nuisance, storage area, sorting and removal.
- Comfort and health:
 - Hygrothermal comfort: control of temperatures and air humidity, homogeneity;
 - Visual comfort: natural and artificial lighting;
 - Acoustic comfort: nuisance control with regard to internal and external sources, including equipment;
 - Health: quality of air, water and space (emissions).
- Social value:
 - Serviceability;
 - Mobility;
 - Accessibility;
 - Crime prevention.

Each theme is graded from A to E:

- | | | |
|------|---------------------|------------|
| - A: | outstanding result | > 85% |
| - B: | very good result | 76% to 85% |
| - C: | good result | 65% to 75% |
| - D: | satisfactory result | 50% to 64% |
| - E: | inadequate result | < 50% |

The scoring system is as follows:

SUSTAINABLE REFURBISHMENT OF SCHOOL BUILDINGS

0. INTRODUCTION



- Award of a number of points for each category and application of a weighting factor;
- Total of weighted points expressed as a percentage per theme;
- Graphic display of results.

0.5.2.1. Cross-comparison between environmental certifications

The table below presents a cross-comparison between the various environmental certifications.

	BREEAM (EN)	LEED (US)	DGNB	TQB	GREENSTAR	VALIDEO	ITACA
Stages of project							
Design	X	X	X	X	X	X	
Building	X	X	X	X	X	X	
End of building step	X		X	X		X	
Operation	X		X				
Type of project							
Residential - individual housing	X		X	X			
Residential - collective dwellings	X	X	X	X	X	X	
Non residential	X	X	X	X	X	X	
School building	X	X	X	X	X	X	
Type of works							
New construction	X	X	X	X	X	X	
Renovation / rehabilitation	X	X	X	X	X	X	
Interior	X						
Extension	X		X	X	X	X	
New district			X	X			
Number of themes analyzed	9 + 1 (bonus)	5 + 2 (bonus)	5 + 1	5	8 + 1 (bonus)	4 * 4	
Requirements							
Easy access to public transport	X	X	X	X	X	X	
Alternative transportation - bicycle facilities	X	X	X	X	X	X	
Transportation - parking capacity	X	X	X		X	X	
Secure access routes	X			X		X	
Travel plan	X			X	X		
Accessibility for disabled persons	X	X	X	X		X	
Sharing of equipment	X	X				X	
Building site : local supply	X			X			
Building site: presence of services	X	X	X	X		X	
Building site: presence of social infrastructure		X	X	X			
Building site : presence of relaxation infrastructure			X	X			
Building site: equipment and community connectivity		X	X				
Building site: land use	X		X	X	X	X	
Building site: biodiversity protection	X		X	X	X		
Building site: presence of magnetic fields				X			
Building site: maximization of open spaces		X	X		X	X	
Building site: risks of natural disasters	X		X	X			
Building site: rainwater management	X	X	(X)		X	X	
Building site: reduction of the heat island effect		X					
Plan and comprehensive management of site		X	X		X	X	
Global warming potential	X		X	X	X		
Ozone depletion potential	X		X				
Photochemical ozone creation potential	X		X				
Acidification potential	X		X			X	
Eutrophication potential	X		X				
Other environmental impact	X		X				
Risks for local environment	X		X			X	
Microclimate			X				
Non renewal primary energy demand	X		X		X		
Total primary energy demand	X		X	X	X		
Production of renewable energy (on site)	X	X	(X)				
Green Power (for electricity)	X	X	(X)				
Optimization of energy performance	X	X	X		X		
Air tightness	X		X	X		X	
Elimination of thermal bridges	X		X	X		X	
Energy efficient outdoor lighting	X				X	X	
Heating energy demand	X			X			
Monitoring and control of energy consumption	X	X	?			X	
Use of "zero or low carbon" technology	X		X			X	
Use of energy efficient equipment	X		X		X	X	
Water leak detection system	X				X	X	
Consumption of drinking water	X	X	X		X	X	
Monitoring and control of water consumption	X	X		X	X		
Use of rainwater / recycled water	X		X	X		X	
Efficient sanitary equipment	X	X	X	X	X		
Water quality (hot / cold)	X			X		X	
Recycling system for wastewater	X	X	X		X	X	
Rainwater management	X	X	X		X	X	
Effectiveness of floor surfaces used			X	X	X	X	

SUSTAINABLE REFURBISHMENT OF SCHOOL BUILDINGS

0. INTRODUCTION



Stages of project	Design	X	X	X	X	X	X	
	Building	X	X	X	X	X	X	
	End of building step	X		X	X		X	
	Operation	X		X				
Type of project	Residential - individual housing	X		X	X			
	Residential - collective dwellings	X	X	X	X	X	X	
	Non residential	X	X	X	X	X	X	
	School building	X	X	X	x	X	X	
Type of works	New construction	X	X	X	X	X	X	
	Renovation / rehabilitation	X	X	X	X	X	X	
	Interior	X						
	Extension	X		X	X	X	X	
	New district			X	X			
Number of themes analyzed		9 + 1 (bonus)	5 + 2 (bonus)	5 + 1	5	8 + 1 (bonus)	4 * 4	
Use of local or regional building materials	Use of local or regional building materials	X	X	X	X		X	
	Use of recycled or reused building materials	X	X	X	X	X	X	
	Use rapidly renewable materials	X	X	X	X	X	X	
	Use of certified woods	X	X	X		X		
	Use of eco-labeled materials	X		X	X	X	X	
	No use of "critical" materials			X	X	X	X	
	Environmental impact of building materials	X		X		X	X	
	Responsible supply of building materials	X			X			
	Selection of insulation material	X		X		X		
	Designed for robustness	X		X				
Designed for disassembly			X		X	X		
Thermal comfort in winter	Thermal comfort in winter	X	X	X	X	X	X	
	Thermal comfort in summer	X	X	X	X	X	X	
	Building regulation	X	X	X	X	X	X	
	Gestion et contrôle des systèmes - confort therm.	X			X		X	
	Users influence	X		X	X		X	
	Indoor air quality	X	X	X		X	X	
	low-emitting materials	X	X	X	X	X	X	
	Ventilation systems	X	X		X	X	X	
	Prevention and protection against moisture		X	X	X		X	
	Control of indoor pollutants	X	X	X				
	Management Plan IAQ - during construction		X					
	Management Plan IAQ - before operation		X			X		
	Acoustical comfort	X	X	X	X		X	
	Acoustical planning of building	X		?	X		X	
	Protection against noise	X		X	X	X	X	
	Ambient noise level	X			X	X	X	
	Insulation values - aerial noise - partition walls	X			X		X	
	Insulation values - aerial noise - floors	X			X		X	
	Insulation value - impact noise - floors	X			X		X	
	Visual comfort	X	X	X	X	X	X	
Natural light - daylight factor	X		X	X		X		
Glare protection	X		X		X	X		
Daylight - nbr of hours of sunshine in winter			?	X		X		
Zoning of artificial lighting	X		?		X			
Quality of view	X	X	?		X	X		
Management and control systems - visual comfort	X	X	?		X	X		
Life cycle cost assessments	Life cycle cost assessments	X		X	X			
	Integrated planning			X	X	X		
	Responsible building practices	X		X			X	
	Operation and maintenance	X		X	X	X		
	Security and risk of failure			X			X	
	Logistics and Transportation Management	X			X			
	Durability and adaptability of the building			X			X	
	Flexibility of equipments							
	Transformation possibilities			X		X		
	Planning of equipments lifespan							
	Dematerialization					X	X	
	Waste management - building site	X	X	X	X			
	Waste management - operation	X			X			
	Fire protection			X	X	X		
	Fire protection - building elements			?	X			
	Fire protection - detection				X			
	Fire protection - extinguishing system				X			
Commissioning	X		X		X	X		
Guide for right operation	X		X		X	X		

SUSTAINABLE REFURBISHMENT OF SCHOOL BUILDINGS

0. INTRODUCTION



Picture: Catherine Massart



Picture: © reseau-idee.be



Picture: Sylvie Rouche

0.6. Conducting a successful school refurbishment project

Preliminary remarks

Each refurbishment project is different.

This document gives guidelines to follow to achieve goals set in terms of consumption (energy, water, materials) and comfort (indoor and outdoor). These guidelines remain generalisations and must be adapted to each project, according to its particular characteristics, in order to achieve the optimum set by the designer or by the project owner.

0.6.1 Analysis of the situation and the constraints, goals to be achieved

The goals to be achieved by the refurbishment project must be set on the basis of analysis of the existing school building or buildings, of the people involved in the school and their needs as well as site contexts:

→ Analysis of problems encountered within the building(s):

- Safety problems: fire, asbestos or materials problems, non-compliant components etc.;
- Health or hygiene problems: mould, dampness, inadequate sanitary facilities etc.;
- Dilapidation or lack of comfort: deterioration of particular installations, structural or building components, obsolescence of heating, lighting or ventilation systems etc.;
- Spatial or functional problems: lack of specific premises, lack of playground, need for new teaching infrastructure (according to the population using the school), unsuitability of premises with regard to the teaching project etc.;
- Financial problems: excessive energy bills, rising operational and maintenance costs etc.

This analysis must permit identification of the desired or planned level of refurbishment. This level of refurbishment must be reconciled with the allocated budget and a schedule of works.

→ Analysis of the quality of the school building(s) to be refurbished: quality of the building in its immediate environment, architectural quality (partially or totally protected building), quality of construction and materials, spatial qualities, functional or operational qualities etc.

This analysis should allow determination of whether it would be preferable to conserve and refurbish the buildings or, alternatively, to demolish and rebuild. It will also allow assessment of the adaptability of the buildings to current and future educational needs (immediate and long-term).

→ Analysis of needs, expectations and skills of the various players, primarily teachers and pupils:

- Functional needs: installation of new equipment or new functions;
- Spatial needs: creation of new premises, new playground areas or green areas etc.;
- Management, human resources, communications and perhaps even energy management skills.

This analysis is important because, in adhering to the requirements and needs of the school's players, by listening to various approaches and taking into account views on the future of the school, it allows them to take ownership of the refurbishment project and to project themselves into the immediate future of their school. Thus it leads to active participation in the refurbishment project and in the future operation of the refurbished buildings.

This analysis is, without a doubt, the most difficult to carry out because it assembles the needs of numerous players, each of whom has a different vision of the school and prioritises some things more than others.



→ Analysis of the context and immediate environment of the school buildings and their relationship with their environment.

The word «context» comes from the Latin verb «con textere»: «to weave with». It introduces the ideas of weft (urban fabric, ecological mesh), rhythm and interdependence (the relationship between the building to be refurbished and its environment).

If a sustainably designed school building refurbishment project tries, first and foremost, to improve the liveability and operational qualities of buildings and their adjacent areas and to enhance the energy and environmental performances of buildings, the refurbishment project must also take into account the immediate environment of the school in order to:

- take on board the advantages, qualities or existing functions of the immediate environment;
- enrich the surrounding context with sustainable and durable qualities;
- create or recreate links and «shared» spaces with the immediate environment.

To do this, the analysis turns its attention to:

- the urban context of the school buildings. Is the school located in a town or in a rural area? Is it in a residential area or in a more mixed area?
- the proximity of services and shops;
- opportunities for connections with the public transport network and proximity of bus or tram stops and underground stations;
- the proximity of parks, playing fields and other leisure facilities;
- the proximity of cultural and/or sports infrastructure: library, theatre, cinema, sports hall, swimming pool etc.

This analysis must enable identification of relationships between the school and its immediate neighbourhood, the presence or absence of specific infrastructure (if lacking, this infrastructure could be provided within the school refurbishment project), the presence or absence of green and leisure areas from which the school might benefit, accessibility of public transport etc.

The goal is to arouse, create or strengthen interactions and exchanges between the school and its immediate environment through the sharing of functions and/or spaces, through participation in shared activities in a way that encourages the integration and participation of the school in its environment and also to encourage social connections.

0.6.2 Setting goals and defining options

Once the initial analysis has been carried out, the goals to be achieved should be set. These goals can be of various types: remedying unsanitary and/or unsafe conditions, achieving a particular level of energy or environmental efficiency, reviewing the building's operational qualities in relation to the educational project, extending the school, providing new play areas etc.

Whatever they may be, the goals provide an opportunity to launch a sustainable refurbishment project based upon a transparent, holistic, participative and preventive approach and a long-term perspective.

Unsanitary or unsafe conditions must be dealt with as a priority. Neither the health nor the safety of the children can be neglected.

Operational quality, or functional goals must be thought out according to the educational project of the school, with a long-term perspective (immediate future and the long term). They are, simultaneously, dependent upon:

- educational needs;
- qualities of existing building(s);
- quality of outdoor areas;
- opportunities for extension or installation of new functions;
- budget limits.

Energy goals simultaneously depend upon:

- the type of building to be refurbished, how it is laid out and its environment, type and components;
- the type of refurbishment (minor or major according to the scale of works) or extension with refurbishment that it is intended to carry out;
- budget limits.

Sustainable goals mainly depend upon the will of the designer and the players in the school to:

- work in a comprehensive way, including other priorities as well as energy (water, waste, materials etc.);
- work within existing contexts (environmental, social economic);
- participate in the refurbishment process and in the proper operation of the school building(s), once refurbish-

0. INTRODUCTION



ment is complete.

Several options can be proposed when goals are being set. These will highlight various aspects of requirements (educational, energy and/or environmental). These various options will need to be analysed both with regard to budget and works scheduling.

0.6.3. Analysis of constraints and action to overcome them

A great many constraints or barriers may become evident during the programming of a refurbishment project. These may be financial, technical, linked to works scheduling or to the future operation of the buildings.

It is, thus, worthwhile to be able to rapidly identify these constraints and set out various forms of action to be taken to overcome some of them.

0.6.4. Works scheduling

It is hard to envisage closing school buildings for several months, or even a year, and relocating teachers and pupils for the sake of refurbishment work.

Various questions should, thus, be posed when scheduling work:

- What types of works are proposed? structural work, demolition work, interior fitting out, utilities renewal (electricity, water etc.), extension work, replacement of window and door frames, roof insulation etc.
- What will those works involve with regard to construction site's infrastructure?
- Is there space within the school or areas adjacent to the school to install that construction site's infrastructure?
- What sort of discomfort will those works involve (noise, dust, other)?
- What demands will those works impose in terms of supply and construction plant traffic?

These initial questions will enable assessment of whether the refurbishment work can conceivably be carried out during term time, while the school operates indoors.

There are several possible scenarios:

- Some classes or facilities might have to be relocated; The school may or may not have adequate vacant premises to enable this relocation;
- The works proposed might be carried out in several phases, during school holidays or, on the contrary, they might have to be carried out over several consecutive months, in a single phase;
- The works proposed might required the school to be closed for several months and involve relocation of all teachers and pupils.

0.6.5. Participation of users in the school: teachers and pupils

Sustainable refurbishment of buildings does not dictate a new lifestyle, but it does require a more or less swift realisation that the future of the planet depends upon a certain number of actions being taken, with regard to both energy and the environment.

A school building refurbishment project that is planned, implemented and operated in a sustainable way is a real opportunity for informing and raising the consciousness of the users within a school, the children most of all, about the energy, environmental and social challenges facing our society. It is also a great opportunity for promoting changes in behaviour and attitudes with regard to use and operation of the buildings. Indeed, by teaching children to think, act and consume differently; by getting them to inhabit an exemplary building and by making them aware of its use and operation, all the families involved with the refurbished school will be affected, made aware and will, in the fairly short term, change their behaviour.

This has been proved in France with regard to food. Some French schools, in order to put an end to the phenomenon of junk food, decided that the children would take all their meals at school for a period of several weeks. The goal was to make them aware of and informed about healthy eating. That initiative affected most of the families concerned, who, through their children, changed their eating habits as a result.

During the school refurbishment project, certain choices must be made by the actors in the school, the organising and financial authority, and the designer in order to noticeably change the energy and environmental performance of the buildings.

If one wishes the buildings to achieve and to maintain over time the maximum performance, it is essential that the various



users within the school understand, accept and adopt certain behaviours, in particular with regard to their consumption and comfort (heating, lighting, water etc.).

Acceptance – and thus adoption – of new behaviours will be facilitated if the players within the school are involved as early as possible in the refurbishment project and if that project takes account their specific needs.

Some essential themes, such as water consumption, waste sorting and collection, will need to be the subject of an information and awareness-raising campaign during the refurbishment project design and on-site works phases, but can also be the subject of coursework or of a theme adopted for the year.

In addition, the involvement of occupants/users and making them responsible both for the good operation of the various systems and/or technical facilities included in the refurbished buildings, will also make them regularly monitor consumption and the upkeep or maintenance of installed systems.

That is why, with regard to school buildings, several steps can be implemented:

- from the time of reoccupation of the premises, all players in the school will receive general information about the operation of the building and the various systems or technologies included. This information is important because it makes users aware of the influence they can exercise on the quality of use and good operation of the building;
- this information can be complemented by a short follow-up and readjustment period with a technical adviser;
- one person within the school – the school caretaker, the person responsible for maintenance or a motivated teacher – needs to acquire the necessary technical skills for the management and maintenance of the building. That person will have a major role in the school, because they will need to constantly make the users aware of how to use the building properly.

0.6.6. The economic aspect

Passivhaus standard, environmentally sound and sustainable construction and refurbishment are now perceived as an extra financial and technical constraint, even if everybody agrees nowadays on the importance of environmentally sound, passive and sustainable construction.

It is obvious that major refurbishment of a school, by favouring the concept of passivhaus standard or low energy standard is not easy either from an economic or a practical and technical point of view.

This can be explained in a number of ways:

- the doubts of private and/or public project owners about possible excessive costs linked to this type of refurbishment and about the real increase in comfort;;
- the lack of information, training and know-how in the construction sector (architects and contractors), which inevitably leads to cost overrun.

Nonetheless, even if it may be thought that refurbishing in a sustainable and strongly energy-efficient way will involve extra cost as compared with traditional refurbishment, it is important to state that, in the long term, this type of refurbishment will prove to be more financially attractive:

- costs in connection with use of the buildings (heating, air conditioning, lighting, electricity and drinking water requirements etc.) will be considerably reduced, by contrast with various energy costs that are bound to rise in the coming decades;
- the value and quality of school buildings will be enhanced as a result of their performance, which will lead to improvement of children's learning performance and motivation of teachers.

But there remains a fundamental question with regard to comfort, well-being and quality of life: can one really quantify the human and social benefits of this type of refurbishment?

Can one really put a price on the comfort and well-being of children and their learning performance?

Can one really put a price on breathing cleaner air?

Can one put a price on the social relationships that we establish in our district or in our children's school?

Can one put a price on the joy of being able to walk or use a bicycle safely and to enjoy accessible, adjacent green spaces?

It is through posing these questions that one can grasp the full potential richness of sustainable construction and refurbishment, which it is so difficult to quantify.

The economic crisis within which we live today could be the dreamed-of opportunity to radically change our ways of thinking and acting, putting humanity back in the centre of our thoughts about construction and realising that we are part of an environmental, social and economic ecosystem.

1. COMFORT AND QUALITY OF LIVE

1.	Concept of comfort	033
1.1.	Various types of comfort	034
1.1.1.	Thermal comfort	034
1.1.2.	Acoustical comfort	035
1.1.3.	Visual comfort	035
1.1.4.	Indoor air quality or respiratory comfort	036
1.2.	Impact of discomfort on children's health and behaviour	037
1.2.1.	Thermal discomfort	037
1.2.2.	Acoustic discomfort	037
1.2.3.	Visual discomfort	038
1.2.4.	Respiratory discomfort or poor air quality	038
2.	Optimising classrooms comfort - goals to be achieved	039
2.1.	European standard and regulations on classroom comfort	039
2.2.	First stage, building audit	040
2.3.	Second stage, settings goals	040
2.3.1.	Goals for thermal comfort	040
2.3.2.	Goals for acoustic comfort	041

Picture: Sylvie Rouché

2.3.3.	Goals for visual comfort	041
2.3.4.	Goals for indoor air quality	043
3.	Ensuring the thermal comfort of children and teachers in the school	044
3.1.	Strategies for ensuring thermal comfort	044
3.1.1.	Heating strategy	044
3.1.2.	Cooling strategy	045
3.2.	Optimising the volume and compactness of the existing building	045
3.2.1.	Optimising the volume	045
3.2.2.	Functional distribution according orientation	046
3.3.	Optimising the envelope of an existing school building	047
3.3.1.	Durability of envelope materials	048
3.3.2.	Quality of installation and use	048
3.3.3.	Upkeep and maintenance	048
3.4.	Insulation of the envelope	049
3.4.1.	Basic principles	049
3.4.2.	Insulation techniques and materials	051
3.4.3.	Insulation - stage 1: Assessing the envelope's condition	058
3.4.4.	Insulation - stage 2: Defining the protected volume	058
3.4.5.	Insulation - stage 3: Selecting performance goals	059
3.4.6.	Repair, upkeep and maintenance	063
3.5.	Remedying thermal bridges	064
3.5.1.	Basic principles	064
3.5.2.	Thermal briges - stage 1: Detecting thermal bridges	065
3.5.3.	Thermal briges - stage 2: Assessing thermal loss and condensation risk	065
3.5.4.	Thermal briges - stage 3: Remediation of thermal briges	066
3.6.	Making the building envelope airtight	069
3.6.1.	Basic principles	069
3.6.2.	Airtightness - stage 1: Checking building airtightness	070
3.6.3.	Airtightness - stage 2: Design and quality of workmanship on site	070
3.6.4.	Airtightness - stage 3: Improving the building's airtightness	071
3.7.	Optimising glazed surfaces	072
3.7.1.	Basic principles	073
3.7.2.	Glazed surfaces - stage 1: Preliminary checks	075
3.7.3.	Glazed surfaces - stage 2: Refurbishment choices	077
3.7.4.	Glazed surfaces - stage 3: Implementation	078
3.8.	Solar protection and management of solar gain	079
3.8.1.	Useful indices	079
3.8.2.	Various forms of solar protection	080
3.8.3.	Solar protection for refurbishment works	082
3.9.	Limiting overheating - refurbishment and thermal inertia	083
3.9.1.	Useful indices	083
3.9.2.	Physical properties of some building materials	083
3.9.3.	Role and impact of thermal inertia	085
3.9.4.	Increasing thermal inertia of building	086
3.10.	Dissipating excess heat - refurbishment and intensive natural ventilation	087
3.10.1.	Basic principles	087

4.	Optimising visual comfort in school building	089
4.1.	Using natural light	089
4.2.	Basic principles	089
4.2.1.	Natural lighting and its variants	089
4.2.2.	Basic characteristics of visual comfort	090
4.3.	Optimising visual comfort in the classroom	093
4.3.1.	Assessing the quality of classroom's illuminance	093
4.3.2.	Classroom type and layout	093
4.3.3.	Improving natural light in classrooms	094
4.3.4.	Provision of artificial lighting	097
5.	Optimising acoustic comfort	098
5.1.	Basic principles	098
5.1.1.	Sound and noise	098
5.1.2.	Noise perception - acoustic comfort	099
5.1.3.	Types of noise	099
5.1.4.	Propagation of noise	100
5.2.	Insulation and acoustic correction	101
5.2.1.	Acoustic properties of building materials	101
5.2.2.	Principles of acoustic insulation	102
5.2.3.	Principles of acoustic correction	103
5.3.	Improving acoustic comfort in classrooms	103
5.3.1.	Room by room assessment	104
5.3.2.	Improving acoustic insulation of classrooms - external noise nuisance	104
5.3.3.	Improving acoustic insulation of classrooms - internal noise nuisance	106
5.3.4.	Improving acoustic insulation of classrooms - noise nuisance from equipment	108
5.3.5.	Acoustic correction of a room	108
6.	Ensuring good indoor air quality	110
6.1.	Limiting pollution of indoor air	110
6.1.1.	Indoor and outdoor pollutants	110
6.1.2.	Assessment of indoor pollution	112
6.1.3.	Limiting indoor pollution by suitable choice of building materials	112
6.1.4.	Occupants' responsibility with regard to indoor air quality	113
6.2.	Installing and optimising the ventilation system	114
6.2.1.	Hygienic ventilation in schools	114
6.2.2.	Difference between air infiltration, hygienic ventilation and intensive ventilation	114
6.2.3.	Ventilation, current regulations and goals to be achieved	115
6.2.4.	Various ventilation systems to consider when refurbishing school buildings	115
6.2.5.	Criteria for selecting a ventilation system	119
6.2.6.	Ventilation and filtration	121
6.2.7.	Ventilation and refurbishment	121
7.	School, a place for teaching and learning	123
7.1.	Space and pedagogy	123
7.1.1.	Children, a specific type of user	123
7.1.2.	Infant classes	125

7.1.3.	Primary classes	125
7.2.	A school accessible to all	125
7.2.1.	Accessibility - major principles	125
7.3.	School refurbishment - meeting current and future needs	127
7.3.1.	Flexibility, neutrality, evolution	127
7.3.2.	Functional quality of school premises	128
7.3.3.	Flexible and adaptable spaces between several classrooms	129
7.3.4.	Ease-of-use of efficient building : simplifying building services and their control	130
7.4.	Learning and new technology: what are the impacts?	130
7.4.1.	E-learning, growth of information technology and energy management	130
7.4.2.	Electrical equipment, mobile phones and Wi-Fi, what is the impact on children's health?	132
8.	Improving the quality-of-life in school	134
8.1.	Optimising the school's outdoor spaces	134
8.1.1.	Playground	135
8.1.2.	Protecting and/or reinstating vegetation to the school	139
8.2.	Encouraging soft mobility for children and teachers	141
8.2.1.	Reducing car use, a pedagogical choice for the school	141
8.2.2.	Means to employ	142
8.3.	Encouraging exchange and interactions between the school and its immediate environment	145
9.	Comfort and quality of life - Breeam assessment method	146
8.1.	HEA 01 : Visual comfort	146
8.2.	HEA 02 : Indoor Air Quality	147
8.3.	HEA 03 : Thermal Comfort	147
8.4.	HEA 04 : Water Quality	148
8.5.	HEA 05 : Acoustic performance	148
8.6.	HEA 06 : Safety and security	149
8.7.	MAN 04 : Stakeholder participation	149
8.8.	ENE 01 : Reduction of emissions	150
8.9.	TRA 01 : Public transport accessibility	150
8.10.	TRA 03 : Cyclist facilities	151
8.11.	TRA 05 : Travel Plan	151
8.12.	LE 04: Enhancing site ecology	152

SUSTAINABLE REFURBISHMENT OF SCHOOL BUILDINGS

1. COMFORT AND QUALITY OF LIFE



1.1. The concept of comfort



Comfort is defined as a general and stable sense of well-being experienced in relation to a person's environment.

Various physical environmental factors influence comfort:

- thermal factors such as the ambient air temperature, the temperature of walls, airflow rate and relative humidity;
- air quality factors such as air speed, fresh air replacement, relative humidity and the presence of odours or pollutants;
- acoustic factors such as the ambient noise level, acoustic nuisances (exterior and interior) and the reverberation time of the noise;
- visual factors such as the amount of natural light, wall colours and texture, the distribution of light within spaces and volumes, the view to the outside.

Certain factors, individual to each person, also condition the perception of comfort. This is about metabolism, clothing, state of health and psychological state. These are factors over which the architect has no control. Comfort is not a purely physical phenomenon. Individuals will feel a sensation of comfort with regard to their environment if they can:

- adapt their behaviour with regard to a situation they feel is uncomfortable (= adaptive capacity); e.g. taking one's jumper off if the temperature is too high
- interacting with one's environment to improve comfort e.g. opening a window to ventilate the premises, lowering a blind to protect oneself from the sun etc.

In the context of sustainable refurbishment of school buildings, prioritising the improvement of comfort allows the user to be reinstated at the core of the project and the specific needs of the child or young person to be integrated within it. This priority is all the more important since:

- the school population is a large one, for both children and teachers;
- the physical and psychological development of children is strongly influenced by the settings or environments they live in, principally school and home;
- educational spaces, both interior and exterior are also a major source of learning.

The built space is a source of awakening, of emotions aroused by materials, forms, colours, sounds and light. It has an indisputable educational function and is a factor in children's autonomy and in their cognitive, psychological, affective and social development. Source: Suzanne DEOUX, Bâtir pour la santé des enfants, Medieco Editions, 2010

There is yet another concept, complementary to that of comfort, that of a person's quality of life, which can be defined according to a series of parameters linked to the quality of their external environment (built and unbuilt) and to the relationship a person has with his or her environment. These parameters are as follows:

- the quality of the immediate exterior environment: the presence of communal or meeting spaces, public spaces and green areas;
- the opportunity and ability to travel, safely, on foot or by bicycle;
- the presence of local services accessible on foot or by bicycle;
- the presence of a neighbourhood community life.

These various parameters will give the person living in a neighbourhood, or the user of the building in that neighbourhood, a feeling of belonging and of safety that it is necessary to the quality of life experienced. These various concepts will be briefly addressed in this chapter.

1.1.1. Various types of comfort

1.1.1.1. Thermal comfort

Thermal comfort is defined as a state of physical satisfaction with regard to the thermal environment. Comfort is a state of equilibrium between people and the internal ambience within which they live or work.

Under normal conditions, people maintain their body temperature around 36.7°C. As this temperature is always greater than the ambient temperature, a balance must be found to ensure the individual's well-being.

This thermal equilibrium between individual and environment is achieved by way of various mechanisms as shown in the diagram below. Over 50% of heat loss by the human body occurs by convection with the surrounding air (convection and evaporation through breathing or at the surface of the skin). Transfer by radiation at the surface of the skin represents up to 35%. This important amount of transfer by radiation explains why we are very sensitive to the temperature of the walls around us.

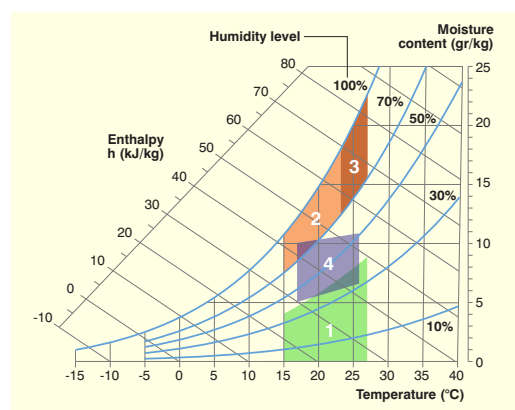
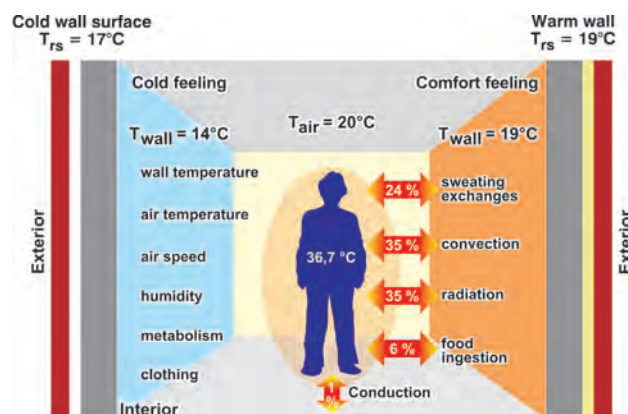

→ The six defining parameters for thermal comfort:

Comfort depends upon six parameters:

- **metabolism** i.e. The human body's production of internal heat, enabling it to maintain a temperature of around 36.7°C;
- **clothing**, which provides thermal resistance to transfers of heat between the skin surface and the environment.
- the **ambient air temperature** T_a and the **average wall temperature** T_w
- the **relative air humidity** (RH), which is the relation, expressed as a percentage, between the amount of water in the air at the ambient temperature (T_a) and the maximum water content for that temperature.
- the **airflow speed**, which affects heat transfer by convection.

→ Perceived comfort temperature

The perceived comfort temperature – also known as «operational temperature» or «dry resultant temperature» – is defined by the formula: **operational $T^\circ = (\text{air } T^\circ + \text{wall } T^\circ) / 2$**

This formula applies so long as the airflow speed does not exceed 0.2 m/s.

→ Natural regulation

The human body has the ability, thanks to various mechanisms, to adapt to a temperature range, in both winter and summer, maintaining a near-constant body temperature of around 37° C. The hypothalamus, which is the temperature regulating centre of the brain, constantly analyses the temperature and compares it to a reference temperature (approximately 37° C). When the body temperature is higher than the reference temperature, the hypothalamus initiates sweating. Evaporation of sweat produces lowering of skin temperature. When the body temperature is lower than the reference temperature, the hypothalamus activates various heat generating mechanisms, such as vasoconstriction, which reduces loss of heat at the body surface (goose pimples); muscular activity (shivering), and heat-producing metabolism.

→ Comfort and relative humidity

Humidity has relatively little impact on people's sensation of comfort in a building. Thus, individuals have difficulty sensing whether the relative humidity of the premises they are in is 40% or 60%. Discomfort is only experienced in extreme situations, i.e. relative humidity lower than 30%, or greater than 70%. For optimal comfort, a relative humidity of between 40% and 65% is recommended for an air temperature of approximately 22° C. A hygrothermal comfort range can be shown

SUSTAINABLE REFURBISHMENT OF SCHOOL BUILDINGS

1. COMFORT AND QUALITY OF LIFE



with more precision in the diagram presented above.

1.1.1.2. Acoustic comfort

Good acoustic comfort has a positive influence on daily quality-of-life and on the relations between building's users.

By contrast, acoustic discomfort produces negative effects on people's state of health and causes nervousness, stress, sleep problems and fatigue.

Acoustic comfort is crucial in educational premises and, particularly, in classrooms, because learning is essentially achieved via oral communication.

«In school, acquisition of knowledge, skills and social norms are very largely dependent on oral communication. Pupils must be able to hear, listen to and understand the teacher's voice. Given how important it is for pupils to learn to manage their own noise, so as not to disturb the group, control of sound and noise in the school enables an acoustic environment of suitable quality for the children's physical and intellectual development. Teaching establishments are, thus, buildings whose acoustic environments are intrinsically linked to their functional quality. An optimal acoustic environment is fundamental for comfortable understanding during prolonged periods of attention. Learning is easier and less tiring; the teacher is more effective and less stressed.» Source: Suzanne DEOUX, Bâtir pour la santé des enfants, Medieco Editions, 2010

The goal of spoken communication is the transmission of sense and not simply the transmission of words. In schools, intelligibility, or understanding of verbal interaction depends upon:

- Speech level;
- Pronunciation;
- Characteristics of interference noise (the acoustic environment of the classroom);
- The acoustic characteristics of the premises within which the verbal message is produced (acoustic resonance in the room or reverberation time).

In a classroom, a teacher's average voice level is approximately 60 dB (+/- 4 dB) at a distance of one metre, which approximates to the first rows of pupils, and is between 45 dB and 52 dB at the back of the class. The greatest part of speech energy lies within a frequency range of between 100 Hz and 6000 Hz. More particularly, for comprehension it lies between 300 Hz and 3000 Hz.

Ambient or background noise interferes with the teacher's speech through a masking effect, thus rendering language incomprehensible. The more background noise shares frequencies with the spoken word, the greater its masking effect and the less comprehensible speech is for the audience.

An instruction or teaching delivered in a loud voice to overcome background noise gives rise to extra effort on the part of the pupil to listen and understand the content, causing fatigue for the child, as well as vocal fatigue for the teacher, causing them stress.

Good acoustic insulation between premises, and between premises and the exterior, with regard to both walls and floors, is equally necessary, so that all the school's activities can take place without disturbing each other or being disturbed by outside noise (road, rail or air traffic, other activities etc.).

1.1.1.3. Visual comfort

→ Light

Perception of light is one of people's most important senses. Thanks to this perception, one can effortlessly sense the space around one and move easily within it. As an interface with the environment, the eye is sensitive not just to the characteristics of light, but also to its variations and distribution. However, the eye has limits with regard to adaptation and accommodation. This defines the limits of visual comfort.

→ Visual comfort

As with thermal comfort, visual comfort is not just a conceptual goal requiring quantifiable and measurable parameters, but also has a subjective dimension that is linked to a state of visual well-being in a particular environment. Visual comfort depends upon:

- Physical parameters, such as illuminance, luminance etc.;
- Characteristics linked to an internal or external environment etc.;
- Characteristics of the task to be carried out, such as reading, office work, goods handling etc.;

- Physiological factors such as age etc.;
- Psychological and sociological factors, such as culture, education etc.

Physical parameters such as luminance, illumination, glare and contrast are the parameters most perceptible to people and, thus, factors for visual comfort. Values are associated with these parameters to ensure good task performance, without fatigue or risk of accident:

- Illuminance is measured in lux (1 lux = 1 lm/m²). It is defined as the quantity of luminous flux (light) received by a surface;
- Luminance, which is more equivalent to the eye's actual perception, is measured in candela/m² or cd/m². It corresponds to the visual experience created by a source or a lit surface;
- Glare is the factor that most interferes with task performance. Glare can be direct or indirect. It is measured with a light meter pointed in a specific direction.

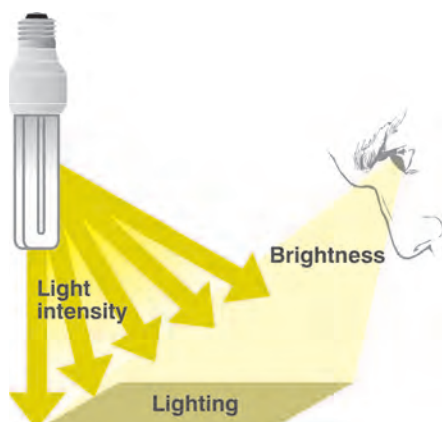

Picture: Sylvie Rouche



Picture: Sylvie Rouche

1.1.1.4. Indoor air quality or respiratory comfort

If a classroom has an inadequate ventilation rate, numerous agents rapidly render its air stale. Indeed, carbon dioxide produced by occupiers, micro-organisms and the aromatic substances that they carry etc. mean that the environment becomes increasingly unhealthy for everyone. Respiration is depressed, premature fatigue occurs and pupils' concentration decreases. The risk of headaches and contamination increases etc.

A person at rest only consumes approximately 0.5 m³ of air per hour for breathing. According to the type of activity, this rate can reach 5 m³/h, while attaining the necessary air-quality requires a ventilation rate of at least 16 m³/h per person (at rest).

These various contaminants and pollutants are pathogens, radioactive particles, dust, organic molecules, aromatic substances and carbon dioxide. Some of these substances can be detected immediately; others are not detectable by the senses even when their concentration exceeds permissible limits.

Thus, two parameters affect respiratory comfort:

- the air change rate;
- pollutants, micro-organisms and aromatic substances inherent to, on one hand, materials and furniture used in the living and work areas and, on the other hand, the occupation of premises and activities within them.

→ The air change rate

There is a relationship between the fresh air flow rate and the expected percentage of dissatisfied persons (PDP). The graph below gives the percentage by volume of ventilation air in mm³/h and per occupant.

A maximum CO₂ concentration of 0.15% (or 1500 ppm) by volume corresponds to an air change rate of 20 m³/h per person, giving an expected PDP of nearly 25%. International standards recommend not accepting more than 20% PDP, corresponding to an air change rate of 30 m³/h per person.

The European standard EN 13779 (Ventilation for buildings – Performance requirements for ventilation and air-conditioning systems, Commission technique CEN/TC 156, 1999) proposes three fresh air flow rates to be observed according to the environmental quality required (for non-smoking premises):

- High indoor air quality: fresh air flow rate 36 m³/h per person;
- Medium environmental air quality: fresh air flow rate 22 m³/h per person;

• Moderate (poor but acceptable environmental air quality): fresh air flow rate 15 m³/h per person;
Standard EN 15251 proposes a fresh air flow rate for classrooms of 7 l/s or 25.2 m³/h per person. This flow rate takes various indoor pollutants into account.

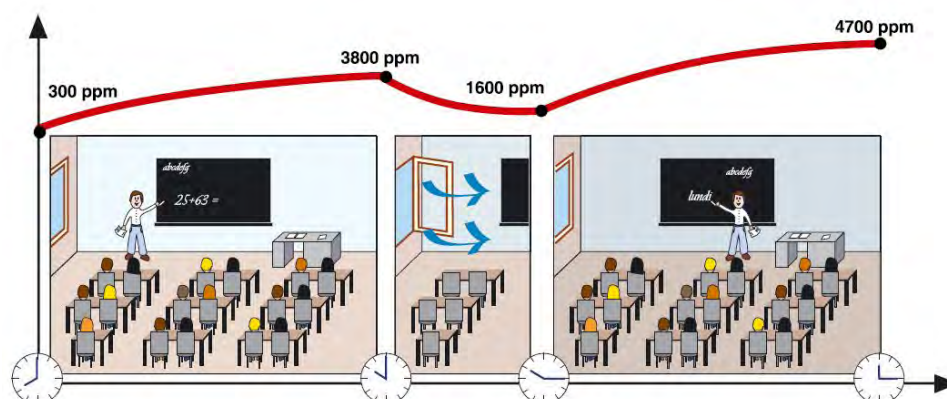

Example of the evolution of CO₂ concentration:

Class of 25 students, 2h course -> 1/4h breaks -> 2h course

Case «no ventilation system installed», infiltration 0.2Vol / h during course and 4Vol / h during breaks.

Source: CETIAT, Ventilation performante dans les écoles.

1.1.2. Impact of discomfort on children's health and behaviour

Discomfort has an impact on adults' and children's health, behaviour and intellectual and/or physical performance. The concept of discomfort is less noticeable in children, because they express their dissatisfaction with their environment much less and are less likely to consider it uncomfortable.

1.1.2.1. Thermal discomfort

People are able to maintain their core temperature within strict limits thanks to temperature regulating mechanisms. These ensure a balance between heat generation (thermogenesis) and heat loss (thermolysis) when the outside temperature varies above or below the thermally neutral range within which a person does not need to expend energy maintaining their core temperature.

Children have less capacity for thermoregulation than adults. They are different from that of an adult morphologically and physiologically, even if core temperature regulation is already fully functional.

Various studies suggest that thermoregulation mechanisms only mature after puberty, especially when the sweat glands are effective. This indicates that the comfort zone of a child in the Givoni chart is smaller than that of an adult. Compared to an adult, a child's thermal transfers with its immediate environment by conduction, convection and radiation are greater and those by evaporation are smaller.

In both winter and summer, the thermal comfort of a school building, obviously, does not just concern the classrooms; however, the time children spend in those rooms, and their relative immobility there, increases comfort requirements.

The effects of hygrothermal discomfort in classrooms can present themselves both as changes to performance, and as changes to health.

- If a classroom is too cold, that disturbs children's attention and makes them agitated and easily distracted, as they seek a way to get warm;
- Excessively high temperatures, increased by classroom occupation density, cause tiredness in pupils and teachers and lead to sleepiness and headaches.

1.1.2.2. Acoustic discomfort

Noise in schools is a major nuisance affecting pupils as well as teachers and other staff.

Studies conducted by Bruxelles Environnement (www.ibgebim.be) highlighted particularly high ambient noise levels (>80 dB (A)) in the canteens and enclosed playgrounds of many Brussels schools.

A study conducted in 2009 in 20 Ile-de-France lycées showed that one pupil in two and one professional in three were subjected, during the course of their school day, to a noise level of > 80 dB(A)¹

WHO studies demonstrate that, in this context, high noise levels reduce pupils' language and reading acquisition. Moreover, discomfort caused by noise often causes changes in social behaviour, reduces supportive behaviour, encourages

¹ dB(A): weighted decibel measurements better reflect the ear's differential perception of frequencies. dB(A) is used to measure environmental noise. This is an A weighted decibel measurement representing one unit of acoustic pressure.



aggressive behaviour and contributes to a sense of abandonment.

While everybody suffers from noise, **it is still more serious for children. Indeed, before even affecting auditory or cardiac systems, the din damages language acquisition from the earliest years.** The average background noise in a classroom is 72 dB(A), i.e. the same as a noisy crossroad. With five-year-old children, the background noise can reach as high as 90 to 95 dB(A). **In addition to fatigue and loss of concentration, there is the problem of language comprehension, since the intelligibility of speech is reduced by over 50% with such background noise.** While some children will manage to compensate outside school for this comprehension deficit, e.g. within their family, those in difficulty will start to accumulate problems, first affecting language, then writing and even reading.

Besides this problem of language comprehension, noise can have various effects on health, both physiological and psychological. The most well-documented physiological effects are hearing damage, cardiovascular disease and sleep disruption. Noise also increases levels of stress, anxiety and nervous fatigue. This can also, inter alia, entail damage to the immune and endocrine systems. These effects can be quantified, quite objectively, by measurement of various parameters (hearing acuity, laboratory tests, blood pressure etc.).

1.1.2.3. Visual discomfort

Glare, reflections, inadequate luminous intensity, loss of contrast etc. can cause visual fatigue, headaches and aggravate pre-existing eyesight problems. Attention span and ability to concentrate are enhanced in an optimised lighting environment. Children are not conscious of poor quality lighting or lack of illuminance. They adapt to insufficient illuminance by making excessive efforts to accommodate, which are the basis of visual fatigue and reduced activity that the child may exhibit. There may be eye, visual or general symptoms:

- Eye discomfort manifests itself as sensations of tension, heaviness or pain in the eyeballs, tingling, burning or itching, later accompanied by watering eyes;
- Visual discomfort shows itself by weakening near or far vision, feeling dazzled, increased sensitivity to light or difficulty focusing;
- The general symptoms are, above all, frontal headaches, loss of attention and, more rarely, dizziness.

1.1.2.4. Respiratory discomfort or poor indoor air quality

All pupils, whatever their age, are vulnerable to polluted indoor air.

The younger the pupil, the more sensitive they will be to air pollutants, as they have a faster metabolism. Unlike adults, they breathe more through the mouth and thus enjoy less advantage of nasal filtration. They breathe faster, inhale more air in relation to their body mass and absorb twice the quantity of pollutants. Repeated and prolonged exposure to pollutants, often in high concentrations, has serious consequences for both their classroom learning and their future respiratory health.

Reduced growth of pulmonary alveoli and inflammation of the airways during the period of rapid lung development affect pulmonary function. This is known as an important factor in morbidity and mortality during adult life. Source: Suzanne DEOUX, Bâtir pour la santé des enfants, Medieco Editions, 2010

Poor air quality in classrooms is synonymous with:

→ Sick building/school syndrome

For several decades, people have spoken about sick building syndrome in office buildings to refer to non-specific health problems, such as headaches, fatigue, eye, nose and throat irritation, dizziness etc.

These same problems occur in schools, where there are sometimes shared episodes of mucus membrane and skin irritation, perception of unusual smells, dryness of the eyes or nose, headache, malaise etc.

While many factors implicated in these problems, lack of air replacement is often involved.

→ Increased spread of infectious illnesses

Poor air quality is a factor in the spread of infectious illnesses. Several studies have demonstrated that this transmission is influenced by the air change rate. The, often permanent, inadequate air change rate in classroom premises contributes to the increased number of viral infections such as rhino-pharyngitis and flu.

→ Aggravation of allergies and increased absenteeism

The closed environment of classrooms aggravates asthma, which affects more and more children and teachers in Europe².

² Several European and International studies have demonstrated the increase of asthma in schools: International Study of Asthma and Allergies in Childhood (ISAAC Study) and the European Community Respiratory Health Survey (ECRHS). and Several European and International studies



Asthma is the principal cause of school absenteeism and chronic illnesses.

The Environment Protection Agency (EPA) Estimates that American children lose 6 million school days per year because of asthma. Source: Suzanne DEOUX, Bâtir pour la santé des enfants, Medieco Editions, 2010

→ Changes in pupils' school performance and the professional performance of teachers

Poor air quality in classroom premises does not provide a favourable climate for learning or teaching effectiveness. The performance levels of both are affected: drowsiness, reduced attention. Various studies have demonstrated that reaction time, grades obtained and mental performance are reduced by inadequate air change rates or a high level of CO₂.

In most European schools, the teacher uses chalk (white or coloured) on a blackboard. Chalk dust – silica dust – is considered to comprise very fine particles that can penetrate deep within the respiratory tracts and is an allergen or aggravating factor for asthma.

1.2. Optimising classrooms comfort - goals to be achieved

Ensuring the comfort of children and teachers in the classroom must be the main challenge in school refurbishment.

In the context of school building refurbishment, while all comfort issues are important, three issues must be prioritised to ensure both teaching and learning quality. These are:

- **Respiratory comfort: air change rate, limiting pollutants linked to materials and activities;**
- **Acoustic comfort: protecting the classroom from noise nuisance, whether outdoor or from other premises, limiting the classroom noise level and optimising reverberation time;**
- **Visual comfort: ensuring an adequate illuminance level and uniform distribution of luminance, mainly from natural light.**

1.2.1. European standard and regulations on classroom comfort

EN15251 is the first European standard that includes criteria for the four indoor environmental factors: Thermal comfort, air quality, lighting, and acoustics.

- Recommended ventilation rate for classrooms: 7 l/s per person or 25.2 m³/h per person. This rate takes account of indoor pollutants
- Maximum amount by which CO₂ concentration exceeds the outdoor concentration: 500 ppm
- Temperature range for classroom heating: 20°C - 24°C
- Temperature range for classroom cooling: 23°C - 26°C
- Noise level (indoor): 35 dB(A) (classrooms), 40 dB(A) (other rooms/areas)
- Recommended artificial lighting level: 300 lux

Some European countries also have specific criteria to ensure comfort in classrooms:

	Denmark Building code	Austria EN 13779	Belgium EN 13779	England and Wales	USA- ASHRAE Standard 62.1 - 2001
Minimum ventilation rate in classrooms	3 to 5 l/s per person + 0.35 l/s per m ² floor area	5.5 l/s per person or 19.8 m ³ /h	6.1 l/s per person or 22 m ³ /h	3 to 5 l/s per person or 11 to 18 m ³ /h	7 l/s per person or 25.2 m ³ /h
Noise LAeg	35 dB(A)	/	/	35 dB(A)	/
Additional requirements	CO ₂ control for 1000 ppm	CO ₂ control for 1000 ppm	/	/	/



1.2.2. First stage, building audit

Before starting to consider the goals to be achieved with regard to comfort and energy performance, as well as deciding what measures to consider, it is crucial to know the state of the building or buildings one intends to refurbish. That is why one always starts with an analysis or audit of the building. The building audit can consider both energy and comfort-related aspects.

→ Energy audit

The energy audit comprises analysis of the operating conditions of the building in order to produce a diagnosis of its energy status. It enables identification of the largest energy consumption categories and the deduction from this of the most economically efficient improvements. The energy audit, thus, aims to:

- know the energy efficiency of the building, producing a survey of energy consumption that takes account of the building's characteristics and use;
- identify energy-related defects and explain any malfunctions;
- propose corrective measures, taking account of the various characteristics related to the building and its use (building structure, wall construction, type of use, type of occupants etc.);
- assess the investment and achievable savings and to produce a chart to help decision-making, enabling the drafting of a documented investment plan addressing the energy, technical and financial issues

The energy audit for school must be broken down into several parts: audit of the building envelope, audit of the heating system, audit of the ventilation system, if any, audit of the air conditioning system, if any and audit of the lighting system.

→ Comfort audit

With regard to comfort, the audit enables identification of the source or origin of any discomfort, whether thermal, acoustic, visual or respiratory: overheating in summer, cold wall sensation in winter, glare or lack of illuminance etc. A series of analyses and measurements will allow evaluation of the comfort or discomfort level and offer ways of improvement.

- Thermal comfort: the tendency of the building to overheat, presence of cold walls, lack of airtightness of walls or glazing units, type of heating etc;
- Visual comfort: illuminance level of the premises, uniformity of illuminance, presence or absence of glare, shadows or reflections, colour rendering, siting and distribution of light fittings, occupant satisfaction level etc;
- Indoor air quality: inadequate air changes, ventilation flow rate, draughts, air infiltration, presence of emission-producing furniture or materials etc;
- Acoustic comfort: lack of insulation with regard to external noise, lack of insulation with regard to neighbouring premises, poor airtightness, noise from ventilation or other equipment etc.

1.2.3. Second stage, setting goals

All improvement measures for an existing building must be considered, while taking account of: the specific needs and priorities of each school, as well as the budget and time available for refurbishment of its buildings. Nonetheless, a specific need (e.g. replacing single glazing with double or triple glazing) may lead to widening the discussion and revising objectives:

- Is classroom illuminance adequate? Is the glazed surface area optimal in relation to the area of the premises?
- Should solar protection be provided? What is the orientation of the facade?
- Should a natural ventilation system be provided (opening window, grille etc.) allowing dissipation of excess heat?

1.2.3.1. Goals for thermal comfort

The goals for assuring thermal comfort of children and teachers in the classroom are as follows:

- **Ensuring a comfortable temperature in both summer and winter** (neither too hot, nor too cold) referring to the European standard recommended temperatures.

European standards EN13779 and EN15251 recommend an operating temperature (or operational temperature) for classrooms of 20°C – 24°C in winter and 23°C – 26°C in summer.

- **Avoiding unwanted draughts** i.e. ensuring adequate airtightness.

Trying to move towards a level of airtightness applying the Passivhaus Standard, or applying the regulations in force in various European and Scandinavian countries.



- **Avoiding exposing children to, or putting them in contact with cold surfaces**, which can cause respiratory problems;

In some poorly insulated, old or prefabricated premises, wall temperatures may be lower than the air temperature, thus making them feel cold.

- **Allowing children to benefit from solar gain in winter** (avoiding glare that is detrimental to visual comfort), **while giving protection from it in summer or mid-season.**

With a view to energy efficiency in attaining these goals, each designer will favour all passive solutions that enable improvement of the energy performance of the school buildings envelope and the use of renewable energy as a complementary resource for achieving comfort temperatures (geothermal, photovoltaic etc.).

Passive methods are methods of architecture and construction that allow good thermal comfort with no or very little energy input. They comprise:

- adequate thermal insulation and airtightness allowing achievement of the «low-energy» or even the «passive» standard;
- treatment of thermal bridging;
- thermal inertia adapted to requirements;
- optimising glazed surfaces;
- means of managing passive solar gain (shading, blinds etc.);
- means of managing the building's natural ventilation during both daytime and night time;

Active measures – i.e. technologies allowing thermal comfort to be ensured by mechanical means: consuming energy to compensate for defects in the building or to augment passive measures. These include heating, cooling and ventilation installations. These measures are described in Chapter 2.

1.2.3.2. Goals for acoustic comfort

Sentences will be incompletely understood unless the difference between the speech sound level and that of the background noise is greater than 15 dB(A) for children with normal hearing and 20 dB(A) for children with hearing difficulties, attention deficit or hyperactivity.

Following the recommendations of the World Health Organisation (WHO), the acoustic comfort goal for school buildings is to provide:

- an ambient noise level no greater than 35 dB(A) in classrooms;
- an ambient noise level no greater than 30 dB(A) in rooms allocated for small children to take naps (nursery school);
- an ambient noise level no greater than 40 dB(A) in other school premises or areas;
- an ambient noise level no greater than 45 dB(A) in corridors and circulation areas;
- an ambient noise level no greater than 50 dB(A) in playgrounds and outdoor areas.

These background noise levels are an ideal to be achieved in the long term, an ideal necessary for children's proper physical and intellectual development.

1.2.3.3. Goals for visual comfort

Classroom activities are organised around the blackboard (or projection screen), the work-surface and the teacher. It is thus important to consider the quality and quantity of illuminance, both vertical (blackboard and screen) and horizontal (work-surface) and general (distribution in the whole of the premises).

The IESNA lighting design guide³ gives recommendations with regard to the quality of its illuminance in schools. According to the guide, the factors that contribute in a significant way to the quality of illuminance in schools are:

- the use and control (management) of natural lighting;
- the elimination of reflections and direct glare;
- the elimination of twinkling and vibration (flickering effect);
- the distribution of light on the various surfaces of the premises;
- the uniformity of illuminance on the work surface.

1. COMFORT AND QUALITY OF LIFE



The following should be added:

- an adequate level of illuminance in order to provide natural lighting for a very great part of the day during the school year;
- a view to the outside for all occupants of the classroom so as to create a relationship with the outdoor space and to offer views that are restful to the eye.

With regard to improvement of visual comfort, it is important to have two strategies for considering windows or glazed surfaces:

- **Providing all occupants with a view to the outside which allows a relationship between the indoor and outdoor space. A view through a window, even if it is not particularly attractive, allows one to locate oneself in relation to the outside world. The opportunity to look through a window is restful and even more fundamental when the visual task requires detailed and close vision.**
- **Allowing a suitable level of visual comfort for the various activities taking place in the premises, no matter where one is located in the classroom.**

→ Proportion of glazed surface in relation to the surface area of the premises

The amount of light entering premises and its distribution often depend upon the size of the window or windows, their orientation, how they are located in the facade or the space, their shape and properties of their components (frame and glazing).

To provide a good compromise between thermal loss and quality of natural light, the net illuminant surface of a room should be no less than 20% of the floor area.

→ Adequate illuminance level

In classrooms, adequate illuminance means sufficient illuminance to allow for good vision during the pupils' various tasks and to facilitate rapid visual accommodation when pupils pass from one task to another.

European standard EN 12464-1, Lights and lighting – Lighting of workplaces, Part 1: Indoor work places recommends a minimum level of illuminance of 300 lux on the work surface in nursery, primary and secondary school classrooms while this same Standard recommends 500 lux for adults.

European Standard EN 15251 also recommends a minimum level of 300 lux.

The table below, from the thesis by B. Piderit «Daylighting design strategies for visual comfort in classrooms» sets out the goals to be achieved in terms of illuminance levels according to activity.

Teacher activity	Pupil activity	Standard Illuminance	
		In class	In general
Writing on blackboard	Reading from blackboard	500 lux (vertical)	200 lux
Talking to pupils	Paying attention to teacher	300 lux	300 lux
Showing a presentation	Watching presentation	300 lux / 10 lux	10 lux
Paying attention to pupils' work	Writing, drawing, reading at the work surface	500 lux	300 lux
Computer activities	Computer activities	300 lux	300 lux

→ Self-sufficiency of natural lighting

Use of at least 50% – 60% natural light (for an 8 a.m. to 6 p.m. working day) is a reasonable goal.

60% daylight autonomy for a workplace occupied from 8 a.m. to 6 p.m. with a minimum illuminance of 500 lux, means that the occupant can, in principle, do without artificial illuminance for 60% of occupancy time.

→ Uniformity of illuminance

Uniform illuminance is necessary to avoid constant, tiring visual adaptation and to assure a similar quality of illuminance wherever the pupil is.

The recommended levels of illuminance in the work area and the area immediately adjacent to it are linked by the uniformity levels set out in Standard EN 12464-1 as follows:

In the work area: $E_{min}/E_{av} > 0.7$

In the immediately adjacent area: $E_{min}/E_{av} > 0.5$

SUSTAINABLE REFURBISHMENT OF SCHOOL BUILDINGS

1. COMFORT AND QUALITY OF LIFE



→ Elimination of glare and shadows

Visual discomfort in an area is often associated with excessive contrast or glare.

Glare is due to excessively intense brightness of surfaces in the visual field or too excessive illuminance contrast between contiguous surfaces. Various types of glare need to be considered for classrooms:

- Direct glare, caused by the presence of an intense light source in the field of vision. E.g. a direct view of the sun through a window;
- Indirect glare from a disturbing reflection of light sources on reflective surfaces, such as a whiteboard, a sheet of paper, a table or a computer screen. Indirect glare occurs in two forms: reflection glare and veiling glare.

Glare is classified into two types according to its intensity, i.e. discomfort glare and disability glare.

1.2.3.4. Goals for indoor air quality

If premises with a high occupancy level have an inadequate ventilation rate, numerous agents rapidly render its air stale. Breathing is less active, premature fatigue is observed, concentration diminishes and there is an increased risk of contamination.

The following goals are intended to ensure the quality of indoor air in the classroom and the respiratory comforts of children and teachers:

- Providing sufficient air replacement to maintain the level of CO₂ around 1000 ppm³ (max. 1500 ppm³) ;
- Avoiding all sources of damp that can cause the occurrence of mould or other pathogens;
- Avoiding exposing children and teachers to finishing and second fix materials liable to emit toxic substances such as chemical pollutants, fine particles, volatile organic compounds, fibres etc.
- Avoiding exposing children and teachers to furniture (tables, chairs, storage units etc.) and decorative objects liable to emit toxic substances such as formaldehyde etc.



Refurbishment of a school in the town of Schwanenstadt, in Austria. The different comforts were revised upwards. Source: www.HAUSderZukunft.at , Pictures © PAUAT Architekten and Günter Lang

SUSTAINABLE REFURBISHMENT OF SCHOOL BUILDINGS

1. COMFORT AND QUALITY OF LIFE



1.3. Ensuring the thermal comfort of children and teachers in the school

1.3.1. Strategies for ensuring thermal comfort

Various passive methods enabling improvement of the building envelope's energy performance are required to ensure the thermal comfort of children and teachers in the school. These passive methods can be summed up in two strategies: Heating strategy and Cooling strategy.

The concept of comfort in classrooms is also affected by their quality of illuminance. This quality of illuminance derives from the match between the activity for which the premises are intended and the quality of light entering them.

During school building refurbishment, use of natural light is preferred, so as to reduce the use of artificial lighting. To achieve this, a strategy of natural lighting will be instituted (see Chapter 4: Visual comfort).

For refurbishment – which is always case-specific – these various passive measures can be planned. They will not always all be applicable and will depend, inter alia, upon the available budget, the occupation of the buildings to be refurbished, the level of refurbishment and the time allowed for the refurbishment works.

1.3.1.1. Heating strategy

The heating strategy enables assurance of comfort in winter, while limiting heating requirements. It is a bioclimatic concept combining various complementary ideas:

→ Harnessing free heat

Harnessing free heat means addressing the orientation of openings and their dimensions. The principle is to open to the south and to a lesser extent in other directions.

→ Storing this heat within the indoor space

Storing the heat means addressing inertia and provision of mass in the indoor space, with regard to both floor slabs (ground and upper floors) and internal walls. Inertia – together with ventilation – allows mitigation of temperature peaks during the day and, sometimes, but not in a regular way, limiting energy requirements (heating and/or air conditioning).

→ Conserving accumulated heat, while still ensuring good indoor air quality

Conserving accumulated heat means, on the one hand, increasing the envelope's insulation and airtightness and, on the other hand, reducing as far as possible thermal bridging or construction joints.

→ Effective heat distribution

Effective heat distribution means addressing the internal layout so as to have a good distribution of heat within the indoor space.

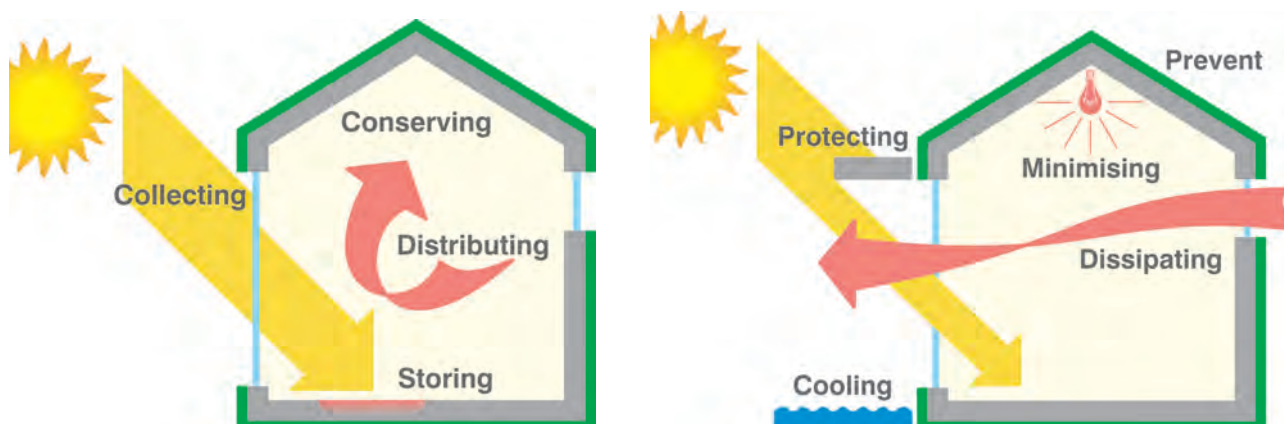



1.3.1.2. Cooling strategy

The cooling strategy enables assurance of comfort in summer, while limiting the use of mechanical air conditioning. It is a bioclimatic concept combining various complementary ideas:

→ Protection from solar gain

In summer, the temperature difference between indoors and outdoors is quite small. Solar gain is, thus, considered to be thermally adverse. It must, therefore, be possible to provide protection from it, i.e. to prevent this solar gain penetrating the interior of the building, by installing solar protection to exposed windows (south, west and, sometimes, east). This solar protection may take the form of either plant screening, or either fixed or movable construction components.

→ Avoiding overheating (mainly in hot countries e.g. Italy)

Avoiding overheating means, on the one hand, increasing the insulation of the envelope surfaces so as to limit heat transfer between the interior and the exterior and, on the other hand, increasing the inertia of indoor areas so as to mitigate temperature peaks at the hottest times of the day, by absorbing excess heat during the day.

→ Minimising internal heat gain

Energy from lighting, computers, fans etc. is transformed into heat within the premises. Minimising indoor heat gain thus means limiting these heat sources by:

- preferring natural light (60% of the time if possible), while providing protection from solar gain;
- choosing efficient and energy-saving lighting installations;
- choosing office equipment that is efficient and energy-saving.

→ Dissipating stored heat

Dissipation of heat stored during the day can be achieved through installation of intensive night time ventilation. During the day, one can also dissipate or limit heat gain by addressing the exterior layout (providing plants close to facades), so as to refresh and humidify the air around the outside of the building.

1.3.2. Optimising the volume and compactness of the existing building

Favouring compactness means, for a fixed habitable space, limiting the heat-loss surface of the building and, thus, on the one hand, its heating requirement and, on the other hand, the quantity of materials required for construction of its envelope. These two points have a direct influence upon the environmental impact of the building and upon its cost.»

Source: Practical guide for sustainable construction and refurbishment of small buildings, IBGE (2007), Brussels: www.ibgebim.be

School building refurbishment is a chance to rethink the operation of the school in a general way, with regard to the distribution of premises, their occupancy and their interior layout. This can be an opportunity to re-examine the volume and compactness of the building, as well as its orientation and the exposure to sunlight of particular premises according to their use and occupancy.

1.3.2.1. Optimising volume

Optimising the volume of an existing building involves addressing its compactness, i.e. minimising the surface of external walls. During refurbishment, the compactness of a building can be improved by:

- Increasing the volume of the building by adding a storey;
- Reducing recesses or hollows in the volume;
- Favouring party walls.

This principle of optimising volume was applied by the architects Heinz Plöderl and PAUAT Architekten, to the **refurbishment of a school in the town of Schwanenstadt, Austria** (see Subtask A «Exemplary projects»).

Two volumetric additions not only allowed a major extension of usable floor area (from 4140 m² to 6214 m²), but noticeably improved the compactness of the existing building while significantly enriching the quality of the interior space (circulation and illuminance).

There is also an economic argument for compactness: reduction in materials used. A simple shape reduces construction (or refurbishment) and maintenance costs.

SUSTAINABLE REFURBISHMENT OF SCHOOL BUILDINGS

1. COMFORT AND QUALITY OF LIFE



Optimising a building's compactness must, however, be balanced with the need to obtain a sufficient south-facing solar absorption surface.

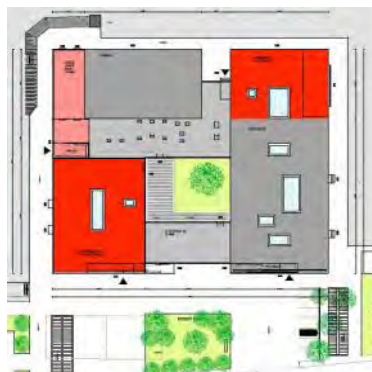

Refurbishment of a school in the town of Schwanenstadt, in Austria. One of the objectives was to increase the compactness with prefabricated façades. Source: www.HAUSderZukunft.at, Pictures © PAUAT Architekten and Günter Lang

1.3.2.2. Functional distribution according to orientation

In the case of a major refurbishment of school buildings, a new functional distribution of the school premises can be considered. This distribution will be planned, on the one hand, according to circulation flows generated by pupils moving between premises and major comings and goings and, on the other hand, according to the orientation and siting of the building in relation to the external environment.

For classroom premises, preference will be given to:

- A north-facing orientation (offset by warmer surface colours), or south-facing¹ orientation (offset by solar protection) in order to assure uniform and comfortable illuminance;
- A view of green areas or common areas of the school, often less noisy than the surrounding outdoor areas.

For other premises, such as the foyer, circulation space and relaxation areas, where uniform illuminance is not a priority, preference will be given to:

- An easterly, southerly or westerly orientation (offset by solar protection);
- An outlook or facade facing the external environment, urban or rural, so as to make the school a participant in the life of the neighbourhood.

This principle of distribution of premises was implemented in the refurbishment project for the **Riva-Bella school** at Braine l'Alleud, Belgium by the «aa-ar» (Alain Richard) architecture office(see Subtask A «Exemplary projects»). This was a major refurbishment of a building that had not been used for several years. The layout of the entire premises was completely revised:

- All the classes are east-facing. They are flooded with natural light and have openings giving onto the campus and other buildings, with which they interact.
- Other spaces and premises face west, towards the town.
- Each activity is allocated a specific location, according to its morphology, size, dimensions openings, connections, views and its relation to outdoor and public space.

¹ An east-facing orientation can also be worth considering for central European countries, but must be used in conjunction with solar protection, mainly to attenuate or reduce visual discomfort and glare caused when the sun is low in the sky.

SUSTAINABLE REFURBISHMENT OF SCHOOL BUILDINGS

1. COMFORT AND QUALITY OF LIFE

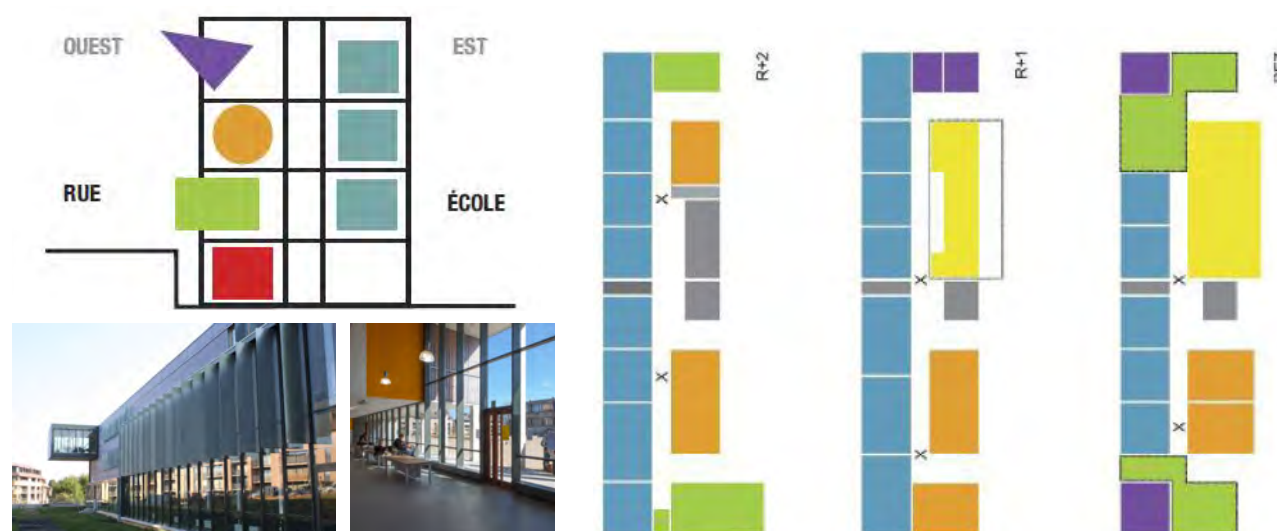

Refurbishment project for the Riva-Bella school at Braine l'Alleud, in Belgium. Source: J.Ph. Possoz, aa-ar (Alain Richard) architecture office

1.3.3. Optimising the envelope of an existing school building

Sustainable refurbishment of school buildings almost demands the optimisation of the envelope of the building or buildings, both with regard to energy, and with regard to thermal, visual and acoustic comfort. The envelope of a building is not just the boundary between the outside and the living or workspace; it is also a protection against the changeable and sometimes uncomfortable (wind, snow, rain etc.) outside climate and enables the maintenance of a comfortable indoor climate.

To be energy efficient, the external envelope must be able to work as a filter:

- Taking advantage of favourable exterior conditions, addressing orientation, siting, spatial layout and use of plants;
- Protecting the interior space it shelters against adverse weather conditions (wind, cold and ice, rain etc.).

With regard to comfort and energy-saving, this means:

- Reducing heating needs in winter;
- Avoiding overheating and use of air conditioning in summer;
- Enabling a degree of self-sufficiency in mid-season.

But, in addition to its thermal performance, the external envelope must also allow for visual comfort (views, quantity and quality of natural light) and acoustic comfort (a barrier against external noise nuisance). These two aspects will be taken up in Chapters 4 and 5 of this section.

Sustainable renovation of school buildings means, with regard to the envelope's energy performance, moving towards the Passivhaus Standard, even if, for various reasons (time, schedule, budget, motivation etc.), this will not always be achieved. In general, in temperate climates, refurbishment of the external envelope must meet the following requirements:

- during the cold season, heat inputs and reduction of thermal loss will be favoured, while maintaining adequate air replacement;
- during the hot season, heat input will be reduced and cooling will be favoured;
- during mid-season, the envelope must be able to adapt to requirements by a combination of the means cited in the first two points.

To accomplish this, the following rules must be observed as far as possible:

- replacement of defective or inefficient glazing and window frames;
- redesign and resizing of openings and/or glazed sections of the envelope according to their orientation;
- improving insulation and airtightness of the external skin (the solid part of the envelope: walls, ground floor slab and roof) in the most continuous way possible;
- effectively protecting south- east- and west-facing openings against solar gain and glare, without reducing reception of natural light;
- if possible, increasing inertia in floor slabs and internal walls.

SUSTAINABLE REFURBISHMENT OF SCHOOL BUILDINGS

1. COMFORT AND QUALITY OF LIFE



1.3.3.1. Durability of envelope materials

School building refurbishment with a view to achieving energy efficiency, must, on the one hand, improve and optimise performance of the envelope (insulation, airtightness etc.), reduce weaknesses (thermal bridging, inadequate airtightness etc.) and, on the other hand, bear in mind the durability of materials and components used.

«... ageing tests have been carried out in the laboratory to estimate the materials' durability, but it is much more complex to address their performance durability once they are in use under actual site conditions and subject to the contingencies of the premises' use.» Source: "La conception Bioclimatique" S. Courgey and J.P. Oliva

It is important when choosing construction materials to satisfy oneself that they will retain their performance in the long term once they are in use. For refurbishment of school buildings, the designer should favour materials that require little maintenance and servicing, are resistant to impact and wear and have a long service life.

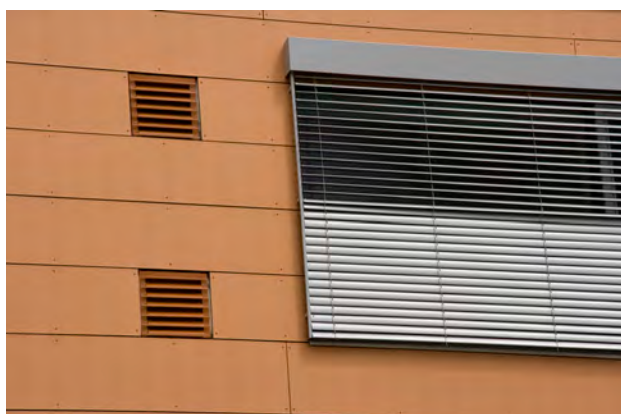

Source: www.HAUSderZukunft.at



© Jørgen Rose and Kirsten Englund Thomsen

1.3.3.2. Quality of installation and use

«The choice of materials and construction techniques is not just conditioned by their technical and environmental performance, but also by whether they can be installed or used properly. Indeed, unsuitable or careless installation can destroy most of the benefits expected from some materials or construction techniques, create damaging defects to the building or even adversely affect its durability.» Source: "La conception Bioclimatique" S. Courgey and J.P. Oliva

Bad workmanship or defects of implementation that can affect the energy performance of the envelope mainly concern waterproofing, airtightness, discontinuities in insulation. It is estimated that in an energy-efficient building, losses due to bad workmanship can lead to excessive consumption of around 35%. It is, thus, essential to take measures with respect to quality and care of implementation, in particular:

- Better training for the various persons involved, about the materials to be used, their performance and interactions that they involve with other components;
- Regular monitoring of the quality of work performed;
- Suitable scheduling and pay to obtain careful implementation (money + time = quality).

However, the care and attention afforded to implementation should not be limited to the installation of the various materials and components. This equally concerns later intervention by other works (plumbing, electricity etc.), which will come into more or less close contact with the materials composing the various walls of the school building or buildings. Thus, all those involved in the construction and refurbishment process need to take into account and respect the work of others involved and need to take responsibility with regard to the quality demanded.

1.3.3.3. Upkeep and maintenance

If the quality of materials used and the quality of their implementation are important factors with regard to the energy performance of the envelope, it is the upkeep and maintenance of insulation, weatherproofing and facing materials that ensure that performance is sustained over time. Indeed, it is essential that the building envelope and its various components are capable of maintaining, for quite a long period of time, the energy performance that motivated its refurbishment. Upkeep and maintenance refers to a set of actions, which can be daily, weekly, monthly or annual and which allow the

SUSTAINABLE REFURBISHMENT OF SCHOOL BUILDINGS

1. COMFORT AND QUALITY OF LIFE



materials used to fulfil their function in an optimal way.

Examples:

- *Window cleaning has an impact on light transmission and visual comfort;*
- *Regular maintenance of timber window and door frames has an impact on their service life;*
- *Checking and maintenance of flat roofs before and after the winter.*

The occupant must, thus, take responsibility both with regard to their duty to maintain their living or work space, as well as its components, in good order and with regard to their duty to carry out possible replacements after a number of years. This acceptance of responsibility can be facilitated by the provision, by the designer and their advisers, of a guide to the proper use and management of the building.

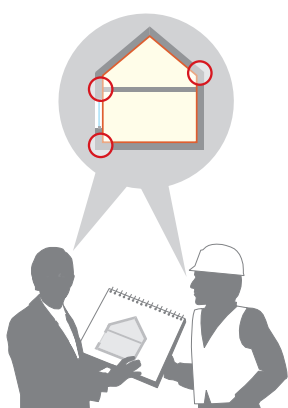

1.3.4. Insulation of school building envelope

1.3.4.1. Basic principles

The insulation layout of a building prevents heat escaping from indoor areas in winter and prevents ingress of external heat into these same indoor areas in summer or mid-season. The role of the insulation is to create a barrier between the interior and the exterior by means of materials with the lowest possible conductivity, so as to drastically reduce thermal loss. Thermal loss is defined as a loss of heat by a building, through its envelope and/or through transfer of fluids between the interior and exterior of the building. This is directly proportionate to the inadequacy of the building's thermal insulation.

This thermal loss is divided into three types:

→ Surface loss

This is loss through the envelope, whether opaque (walls, roofs etc.) or glazed. Surface loss represents up to 60% of total thermal loss of an uninsulated building.

→ Loss through thermal bridging

Thermal bridges are faults of implementation of insulation and are often located at the junction between two walls, wall and ceiling or two separate components. According to the construction techniques and insulation systems used, this loss varies between 5% and 25% of all thermal loss.

→ Loss through air replacement

This is loss associated with the sanitary ventilation system of the building (if any) but also with unwanted and uncontrolled air ingress via exterior joinery (doors and window frames), chimney stacks etc.

So, insulating a building's envelope in the course of refurbishment means:

- **Limiting surface heat loss by adding a continuous layer of insulation;**
- **Limiting heat loss from thermal bridging (see point 3.5);**
- **Limiting heat loss from air renewal (see point 3.6).**

Conduction of heat through a wall or ceiling separating two different environments (interior and exterior) and also wall or

ceiling insulation can be specified by means of several parameters:

→ Thermal conductivity: coefficient λ

The thermal conductivity λ of the material is the heat flow that crosses 1 m² of a 1 m thick wall, when the temperature difference between the two faces of that wall is 1°K. It is measured by the coefficient λ ; the greater λ is, the more the material is conductive and transmits heat; the smaller λ is, the greater the material's insulation qualities. Thermal conductivity is expressed in W/m.K.

→ Thermal resistance: coefficient R

The flow of heat across a wall depends upon its thickness and its thermal conductivity λ . Thermal resistance R is the relationship between thickness and thermal conductivity λ ($R = e/\lambda$). The greater the thermal resistance R, the better insulator the material is. Generally, a wall is constructed of several materials of varying thickness and thermal conductivity. In that event, one adds the R coefficients of each layer. Thermal resistance R is expressed in m²K/W.

→ Thermal transmittance: U-value

To describe the energy performance of the wall, one generally uses the U-value, which is the thermal transmittance coefficient. This coefficient is inversely proportional to the thermal resistance ($U = 1/R$) and is expressed in W/m²K.



«The worst heat conductor is a "void" or empty space, which allows radiant exchanges only (1).

However, "empty space" is actually filled with air, and the hot surface of the air wave exchanges its calories with the cold surface [of the wall] by convection (2).

If the air is to conserve its insulating properties, it must be motionless, which is achieved by enclosing it in the smallest possible alveoli (3)»

Source : Isolation écologique, JP Oliva,



Improving or optimising a building's insulation means considering other parameters as well, such as:

→ Possible thermal bridging

Insulating an existing building, if the principle of continuity is not observed, can create or exacerbate existing thermal bridges. These can cause:

- A relatively very considerable amount of heat loss in relation to total heat loss;
- Surface condensation when the surface temperature falls below the dew point of the ambient air. The dampness thus caused to the wall allows development of mould. This not only looks unpleasant, but also emits substances that can smell and can cause allergic reactions in some people;
- When there are large quantities of condensation that cannot be removed, they penetrate the finishing and second fix materials, causing their deterioration. If the condensation and damp are permanent, the whole thickness of the wall can be very damp. The load-bearing structure can be affected and can deteriorate.

→ Airtightness

Improvement and optimisation of insulation to an existing building must be carried out in conjunction with improvement of airtightness so as to limit heat loss through air replacement.

Poor airtightness causes draughts, leads to a feeling of thermal discomfort and reduces acoustic insulation, which can cause a problem in some urban areas. The impact on a building of lack of airtightness is greater when it is well insulated. The proportion of heat loss due to ventilation is then a much greater part of the total heat loss.

→ Thermal inertia

Improvement or optimisation of an existing building's insulation should be accompanied by consideration of the thermal inertia of the interior. In fact, insulation applied internally can limit or strongly reduce the heat storage capacity of the

SUSTAINABLE REFURBISHMENT OF SCHOOL BUILDINGS

1. COMFORT AND QUALITY OF LIFE



interior.

→ Indoor air quality

Improvement or optimisation of an existing building's insulation should be accompanied by consideration of its ventilation. In fact, an insulated and airtight building, unless equipped with an efficient ventilation system, can tend to favour the containment and concentration of pollutants, the potential development of bacteria and mould causing poor air quality. Such poor air quality will affect the health of children and teachers and also the children's learning abilities.

This is important, insofar as the great majority of Europeans spend more than 85% of their time in the closed environments, where they are exposed to multiple chemical or physical pollutants.

1.3.4.2. Insulation techniques and materials

In refurbishment, when insulating school buildings, care is taken, on the one hand, to insulate the external skin (floor, walls, windows and roof) and, on the other hand, to insulate partitions between heated and non-heated areas (walls, doors etc.).

According to the type of skin or partition to be insulated, there are various insulation techniques. These various techniques are summed up in the diagram below.

We shall deal here with the choice of insulation technique for walls and facades.

The choice of an insulation technique for refurbishment is complex. It is often a compromise between various parameters: performance to be achieved (energy, water tightness etc.), the desired aesthetic qualities, planning constraints, the complexity of facades (flat facade, pierced facade etc.), the available space within the premises, the ease of and time available for executing works, price etc.

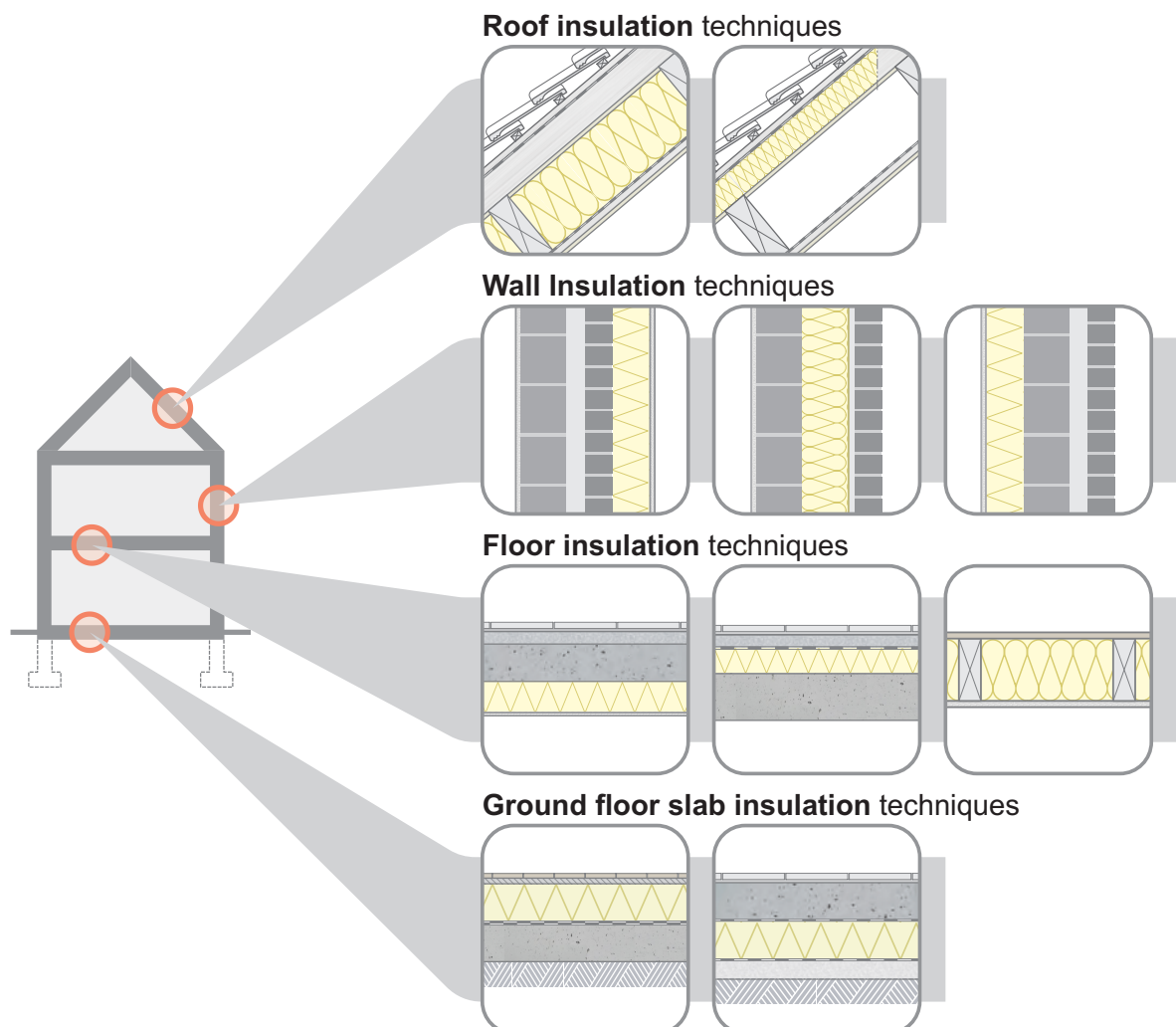

SUSTAINABLE REFURBISHMENT OF SCHOOL BUILDINGS

1. COMFORT AND QUALITY OF LIFE



It is important to properly analyse the scale of works to be carried out. Constraints associated with any particular technique differ and may lead to changes that could be major and onerous. There are three main insulation techniques. These three techniques can be used on the same refurbishment site, according to existing constraints:

- External insulation;
- Internal insulation;
- Cavity wall filling.

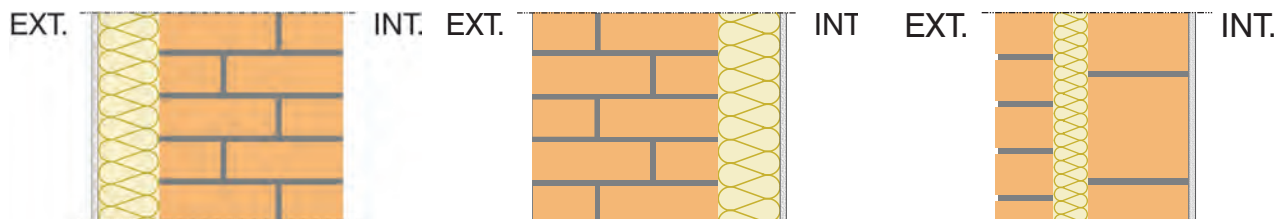

→ External insulation technique

This technique enables avoidance of thermal bridging and condensation effects, thanks to continuity of insulation. This technique also enables conservation of the thermal inertia of the existing building and weatherproofing its structure.

However, external insulation changes the external appearance of the building.

E.g.

Due to its thickness, externally applied insulation makes door and window frames appear deeper set in the facade. Similarly, when it is applied to the lintel and return of a bay, the frame can appear lower.

Planning permission is, therefore, often necessary. On the other hand, if the exterior finish is dilapidated, this system enables improvement of the external appearance.

The insulation must be protected by a new facing: synthetic or mineral render, cladding, or a facing of brick or prefabricated components.

This technique is not always applicable, particularly when buildings front onto the street or when the facades must retain their original appearance (listed or protected building).



© Jørgen Rose and Kirsten Engelund Thomsen



© Jørgen Rose and Kirsten Engelund Thomsen

SUSTAINABLE REFURBISHMENT OF SCHOOL BUILDINGS

1. COMFORT AND QUALITY OF LIFE



→ Internal installation technique

When it is not possible to insulate externally, internal insulation must be considered. This is particularly the case when the exterior facade must be conserved (listed or protected building, facade fronting onto the street etc.).

While external insulation allows the limiting of thermal bridging, internal insulation may, on the contrary, create or exacerbate this. Vulnerable areas, such as joints between external walls and cross walls or floors, as well as the framing of bays, must receive particular attention from the point of view of flows of heat, humidity and air.

It is essential to check, before any internal insulation works, that:

- the exterior facing wall is in good condition and weatherproof;
- the internal load-bearing wall is dry and protected from infiltration;
- the internal layout of frames in relation to bays, of the floor in relation to the internal wall etc. allow control of thermal bridging;
- the indoor climate is normal with regard to temperature and humidity;
- internal walls, partitions and floors have sufficient inertia.

The choice of insulation system will be made according to the available space in the premises and, above all, according to the condition of the internal walls:

- When the internal face of the wall is flat enough, the insulation can be directly glued to it;
- If this is not the case, the insulation is installed on battening, between such battening (risk of thermal bridging) or behind a mortar-bonded rigid lining (providing inertia).



© Isofloc



© Ursa, Grupo Uralita

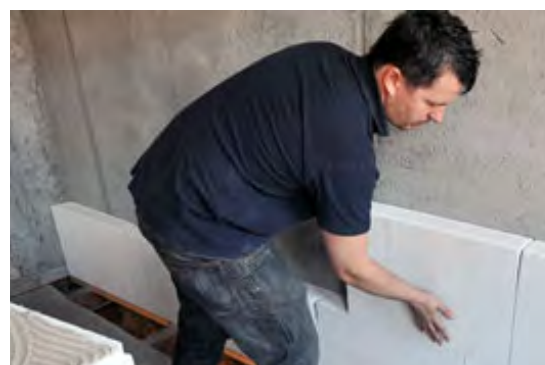

© Xella, Multipor

Comment:

The choice of technique used for installing the insulation will affect its future dismantling (replacement or removal) and its recycling potential. Glued insulation can be difficult to remove from its support, while loose or mechanically fixed insulation can be removed from its support without difficulty and easily recovered or recycled.

Condensation risk

By installing an insulating layer on the internal face of the wall, a barrier is created between the wall and the internal environment, which prevents the wall being heated. As a result, the dew point (which is the source of condensation) is displaced towards the inside.

Therefore, insulation must be installed together with a vapour barrier (highly impermeable to water vapour) or a vapour check (less impermeable to water vapour). This is installed between the insulation and the interior and prevents water vapour condensing between the wall and the insulation.

The choice of a vapour check, which is more permeable to water vapour, often allows one to be prepared for the risk of internal condensation in summer or in spring, or when the pressure of water vapour is greater outdoors than indoors. Other, intelligent, membranes are still more suitable. The permeability of intelligent membranes changes according to the relative humidity. They are designed to be relatively impermeable to water vapour when relative humidity is low and to become permeable to it when relative humidity is higher.

It is important to point out here that certain materials known as «hygroscopic» (wood and wood products, raw clay, cellulose etc.) have the property of being able to regulate indoor humidity by absorbing excess humidity to release it later, thus mitigating the unpleasant effects of excessive dryness or humidity.

1. COMFORT AND QUALITY OF LIFE



The vapour barrier or vapour check not only allows regulation of water vapour, but also blocks airflow and, thus, avoids the risk of condensation by convection, provided of course that the workmanship is of excellent quality.

The principles to be observed when installing insulation are as follows:

- the insulation must be installed in a continuous manner, particularly in corners, so as not to create thermal bridging and thus avoiding surface condensation.
- the vapour barrier must also be installed in a continuous manner, joins must be made airtight.
- an air and water tight finish must be provided to the whole interior surface.

So as to prevent convection, it is important to close all openings that allow interior air to circulate behind the insulation layer. Vulnerable points include the junctions between wall and ceiling, between wall and floor, with bays and with openings for various ducts and pipework, insertions of cable or junction boxes etc.

It should not be forgotten that internal insulation reduces the available indoor space and often requires electrical, sanitary and/or heating appliances and fittings to be moved, if these are located on external walls.

→ Cavity wall insulation

When refurbishing certain types of building, the technique of cavity wall insulation can be considered.

However, this insulation technique has limits. It is to be avoided in the following cases:

- When the desired level of thermal insulation cannot be achieved because the cavity is not wide enough;
- When the exterior surface of the wall is impermeable to water vapour. When one installs cavity wall insulation, water present within the external leaf, due to rainwater infiltration and/or interstitial condensation, must be able to be evacuated by drying out the external leaf. However, because of the insulation, this is now only possible via the exterior face.
- When the masonry of the external leaf is prone to frost damage. Either it may present spalled bricks and/or blown joints, or a laboratory test of a sample may show that the masonry is not capable of resisting the stresses that would be caused by filling the cavity. In fact, when insulation is placed in the cavity, the external leaf is less exposed to the influence of the inside temperature. It will be colder in winter and hotter in summer. The external leaf will be exposed to greater and more frequent variations of temperature and thermal loads will be greater.
- When the facade has major thermal bridges that cannot be remedied;
- When the internal leaf is not airtight (unrendered masonry);
- When there are no, or only ineffective vapour barriers.



© Isover



© Isowit



© Ecobati

Before undertaking insulation works, a preliminary examination of the cavity is required. This will enable the condition and quality of the cavity wall to be checked. This examination is easily carried out, without dismantling the wall, using specialist equipment such as an endoscope.

The following points need to be checked and monitored:

- Whether it is possible to treat thermal bridges at the lintels, bay reveals, floors, bottom of walls, cornice etc.;
- That the cavity does not contain debris, waste or other material;
- Correct installation distribution of wall ties between the two leaves of the wall;
- Presence of correctly installed impermeable membranes;
- Presence of cavity drainage openings just above the impermeable membranes.

There are various methods and materials available for cavity wall insulation.

SUSTAINABLE REFURBISHMENT OF SCHOOL BUILDINGS

1. COMFORT AND QUALITY OF LIFE



Generally, one would choose the loose-fill, blown insulation method. The foam injection method is now little used. It requires precise monitoring of the fill and expansion of the foam to prevent the cavity wall leaf deforming due to the pressure involved. It is strongly recommended to use an insulation method with technical certification. The insulating material must:

- not have either capillary or hydrophilic properties (it must not absorb or retain moisture),
- be sufficiently permeable to water vapour,
- have an adequate consistency so that it does not slump or settle.

→ Insulation techniques compared

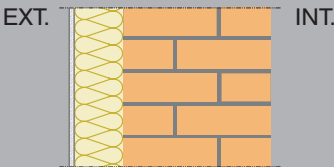
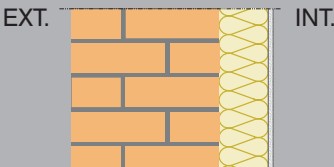
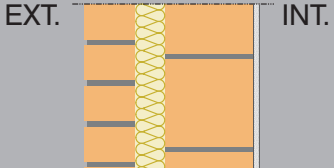
Insulation system	Advantages	Disadvantages
External insulation 	<ul style="list-style-type: none"> • Continuity of the insulation: prevents risks of local thermal bridging; • Improvement of the facade's impermeability; • Protection against frost, cracking and penetration of driving rain; • Improves the external appearance in the case of damaged or patchy exterior finish; • Conservation of thermal mass and interior finishes; • No loss of habitable indoor space. 	<ul style="list-style-type: none"> • Change to external appearance: need for planning permission • In most cases; • Returns need to be insulated, thresholds replaced etc. (reduction of glazed surface); • Moving/replacement/conversion of water downpipes, gutters, gulleys etc.; • Must be done by a specialist company; • High cost, new facing required.
Internal insulation 	<ul style="list-style-type: none"> • External appearance maintained; • No need for scaffolding; • Wide range of choice of insulation materials; • Works sheltered from inclement weather; • Can be carried out room by room, staging of works and costs; • Less expensive; • No need for planning permission. 	<ul style="list-style-type: none"> • Reduction of habitable area; • Need to move or replace interior finishes (and, possibly, electrical, heating and/or plumbing installations) • Increase of hygrothermal stress within the wall: risk of internal condensation, frost damage, bulging of masonry and efflorescence; • Thermal bridging difficult to resolve: risk of surface condensation and mould growth; • Reduction of thermal inertia: risk of overheating.
Cavity wall insulation 	<ul style="list-style-type: none"> • Conservation of interior and exterior finishes; • No intrusion on interior or exterior space; • Thermal mass retained; • Simple technique; • Less expensive; • No need for planning permission. 	<ul style="list-style-type: none"> • Only possible if the cavity is wide enough (min. 4 cm) and regular: preliminary examination essential; • Cannot be used if the external leaf is painted or waterproofed: impermeable layer prevents evacuation of water vapour; • Limited thickness of insulation; • Risk of exacerbating thermal bridging at breaks in the cavity; • Cooling of the external leaf: reduced drying capacity, frost risk.



→ Insulation materials

Insulation materials have nowadays become essential materials for building construction and refurbishment. Because of challenges of climate and increased energy-saving requirements, this is a strongly expanding market.

Mineral wool and synthetic foam insulation dominates the market, but, every year, natural or eco-friendly insulation materials take a greater share of the construction materials market. In fact, over the last 20 years, insulation derived from natural and renewable materials, such as vegetable or animal products, have been rediscovered and their use is increasingly frequent.

There is also a push for research on innovative insulation materials that are thin but highly effective. No doubt, this research is influenced by successive increases in the thickness of insulation to the various elements of the building envelope.

A material is considered to be an insulator when its coefficient of thermal conductivity, when dry, is equal to or less than 0.07 W/mK.

In finished buildings, the insulation materials are generally invisible, hidden behind a facing and/or within a cavity when installed to the exterior of the envelope, or behind a second-fix sheet when installed within the envelope. These materials fulfil a set of tasks and functions: ensuring a pleasant and healthy indoor climate, reducing heat loss by transfer and ventilation, protecting against summer heat and winter cold and frost, giving acoustic protection (according to the type of insulation selected), fire protection (according to the type of insulation selected) etc.

The quality of a well-insulated thermal envelope depends upon the thermal properties of its materials and components, as well as on their design and installation.

Insulation materials can be classified into various categories: according to their basic raw material and according to the type of transformation that material has undergone during the manufacturing process.

According to the raw material used, a distinction is made between mineral (inorganic) and organic insulation materials. According to the manufacturing process and the types of transformation, a distinction is made between natural and synthetic insulation materials.

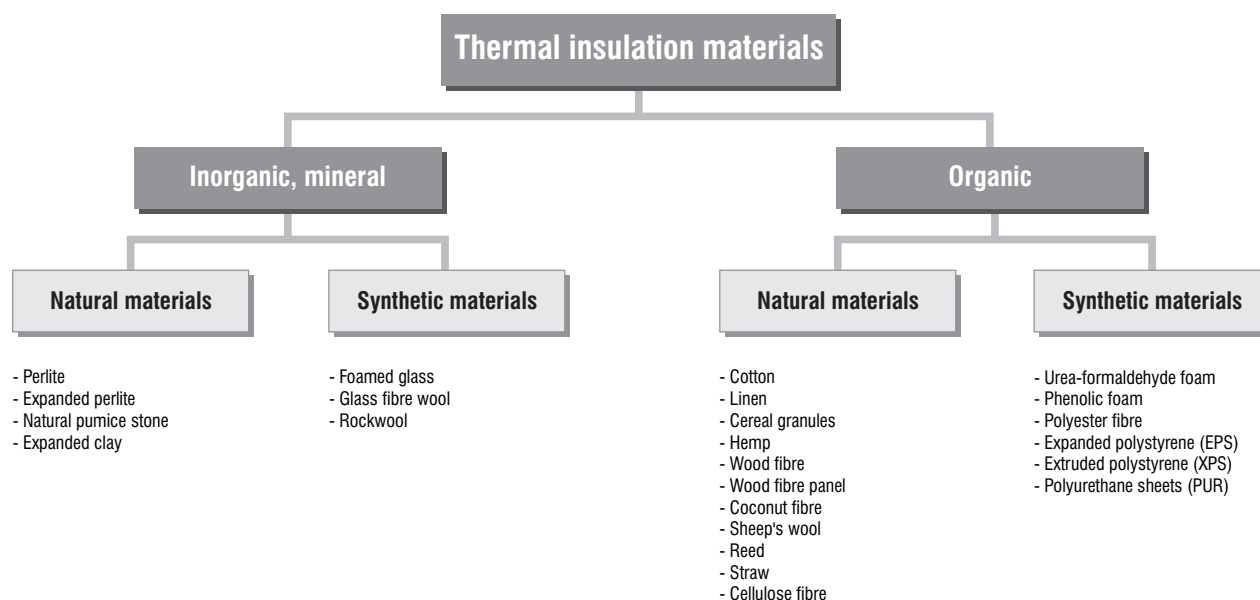

© Sophie Trachte, Matériau, matière d'Architecture Soutenable

The insulation materials can take various forms: rigid panels, blankets, felt, packing wool, loose-fill material, or foam that is moulded or sprayed in situ.

Suitable choice of insulation material must involve taking account of the construction of the building to be refurbished (techniques and materials), technical regulations and particular requirements to be observed. Account must be taken of:

- the product's dimensions, its volumetric mass and intrinsic properties;
- its strength (resistance to pressure or compression, tensile strength, adhesive strength of foams);
- its dimensional stability when exposed to cold or heat;
- its thermal properties (conductivity and thermal resistance, thermal storage capacity) and its acoustic properties;

SUSTAINABLE REFURBISHMENT OF SCHOOL BUILDINGS

1. COMFORT AND QUALITY OF LIFE



- the protection it affords against damp (permeability to water vapour or to liquid water etc.);
- the protection it affords against fire.

Selection of an insulation material must also involve sustainable development priorities i.e. taking account of its impact on the environment and health, of its durability (resistance to ageing, UV light, excessive humidity etc.) and, also, of its cost and the financial investment arising from its use.

Independently from the selection of insulation material, various types of fixings or mountings can be identified. The choice of fixing must, thus, have a considerable influence on the future management of the insulation material (reuse, recycling etc.).

Loose-fill generally requires preparation of a casing to receive the insulation, in the form of beads, granules or flakes. Loose-fill insulation can be simply installed by pouring, ramming or injecting.

Mechanical fixing is often used when the insulation is installed as a fill in a structure. Hooks or nails are then used to fix the insulation material after having wedged it between the vertical elements of the structure. Insulation can also be fixed as panels, using insulation fixing dowels, when the insulation is installed to the exterior of existing walls. Loose-fill or mechanical fixing is completely reversible and, in theory, the insulation material can be reused so long as, when the building is dismantled, it is treated separately from the other materials.

Installations that require use of an adhesive (insulation materials in panel or roll form), or of a binder (loose-fill insulation materials) are not generally reversible.

The insulation material is bound or stuck to one or more other materials and it cannot be as easily dismantled as is the case with insulation materials used loose or mechanically fixed. Most of the time, materials installed using adhesive or a binder are unusable after dismantling.

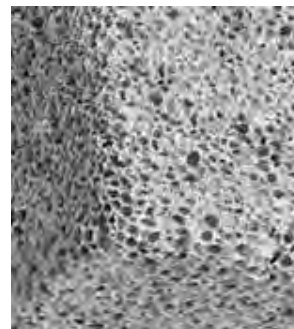
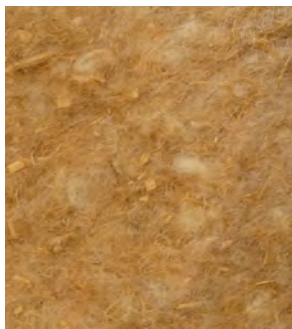

1. Hemp
2. Cellulose flocks
3. Coconut fibers
4. Flax
5. Cork
6. Wood wool
7. Crushed foam glass
8. Mineral wool
9. Expanded polystyrene (EPS)
10. Polyurethan
11. Extruded polystyrene (XPS)



1.3.4.3. Insulation – Stage 1. Assessing the envelope's condition

Insulation of the envelope skin depends upon the nature, thickness and condition of the various layers of materials that compose it. Thus, it is important to assess the situation and condition of that envelope before undertaking improvement works.

→ External walls

- Do the buildings to be refurbished have blind walls (large windowless surfaces)?
- Are the external walls insulated?
- Are the external walls vulnerable to damp (rain or rising damp), or are they in poor condition (damaged exterior finish, end of service life, damaged joints etc.)?
- Is there damp or mould inside the building?

→ Frames and glazing

- Is some glazing in poor condition (broken and missing glazing)?
- Is it single or double glazing?
- Are the frames in good condition?
- Quality of frames: are they thermally broken and are they airtight?

→ Roofs

- Are they insulated?
- Are the roof coverings in poor condition (moss or lichen, broken tiles or slates etc.)?
- In the case of a flat roof, is the weather proofing in good condition?
- Is there damp or mould inside the building?

→ Ground floor slab

- Is the ground floor slab insulated?
- Is the ground floor slab directly ground bearing or suspended over a ventilated void?
- Are there cellars under the whole or part of the surface?

It is also essential, before carrying out insulation works, to have a good knowledge of the hygrothermal and mechanical properties of the existing building skin and fill materials. One must then be satisfied with the quality of workmanship.

1.3.4.4. Insulation – Stage 2. Defining the protected volume

For refurbishment, it is necessary to determine the space to be protected on the basis of certain characteristics of the building. Improvement of the building envelope can also lead the designer to modify the thermally-insulated space. Indicators of whether a room is or is not included within the thermally-insulated space:

- When there is at least one heating appliance (wood burner, radiator, underfloor heating etc.) in a room, that room is part of the thermally-insulated space;
- When the room is used for an activity that requires thermal comfort (heating or cooling), it necessarily belongs to that insulated space;
- When it is intended to thermally insulate the room from the external environment by insulation of at least one of the surfaces of its envelope. Indicators of a surface's insulation are the presence of an insulating layer ($\lambda < 0.07$ W/mK) or double glazing;
- When contiguous rooms openly connect with each other (bays without doors or windows), either all or none of them form part of a thermally-insulated space;
- When a room is open to the external environment (bays without doors or windows) they do NOT form part of a thermally-insulated space;
- When an insulated wall or ceiling separates two rooms, one may reasonably assume an intention to protect one of them from thermal loss. From which, it may be deduced that one belongs to the thermally-insulated space and the other does not.

In the absence of the above indicators, one may consider that a room belongs to the thermally-insulated space when it is for the most part surrounded by spaces that do form part of it.

In order to improve the thermal performance of the building, it may be advisable to integrate some premises into the ther-



mally-insulated space (e.g. closing a passageway under the building that is open to the elements), or to exclude others (e.g. removing radiators from peripheral premises where heating is unnecessary).

1.3.4.5. Insulation – Stage 3. selecting performance goals

→ European regulatory framework for energy performance

In 2002, following European undertakings in the light of the Kyoto Protocol, the European Union Parliament and Council adopted European Directive (2002/91/CE) on energy performance and indoor climatic conditions of buildings.

That Directive assesses the Energy Performance of Buildings as the amount of energy actually consumed or estimated to meet the different needs associated with a standardised use of the building, which may include, inter-alia, heating, hot water heating, cooling, ventilation and lighting (for non-residential buildings). This amount should be reflected in one or more numeric indicators which have been calculated, taking into account insulation, technical and installation characteristics, design and positioning in relation to climatic aspects, solar exposure and influence of neighbouring structures, own-energy generation and other factors, including indoor climate, that influence the energy demand.» Own-energy generation here means production of energy by systems such as thermal solar panels, photovoltaic cells, cogeneration systems etc.

The Directive requires each member state to define in its local or regional law:

- a calculation method for energy performance of buildings;
- minimum requirements with regard to the energy performance of new buildings and of existing buildings subject to major refurbishment;
- certification schemes for building energy performance;
- requirements with regard to regular inspection of boilers and air-conditioning systems.

In compliance with the Directive, an energy performance certificate, valid for 10 years, must also be issued at each key point of a building's life cycle: at the time of its construction, its sale or its rental.

Before undertaking energy-based renovation of the envelope of a school building, all designers should take into account current regulations.

It is also important to stress that, in spite of the legislative framework of the European Directive, there are many differences between countries with regard to both calculation methods and requirements to be met.

→ Free choice, towards advanced performance

A project owner, or educational establishment, may wish to go beyond the regulatory requirements with regard to energy performance and use of renewable energy. Three standards may thus be highlighted:

Very low energy consumption standard

There is no European definition of this energy standard. Historically, all newly constructed or renovated buildings whose energy performance was better than that required by current standards were described as «low-energy».

In this book, the «very low-energy» standard is considered as a level of performance specified by a heating (and/or cooling) requirement equal to or less than 30 kWh/m² per year, which corresponds to the following insulation coefficients:

Coefficient of thermal insulation	Central Europe	Scandinavian countries - source: Denmark
Max U-value, external walls	0.2 W/m ² K	0.15 W/m ² K
Max U-value, roof	0.2 W/m ² K	0.1 W/m ² K
Max U-value, ground floor slab	0.2 W/m ² K	0.1 W/m ² K
Max U-value, glazed area of door or window frame	1.1 W/m ² K	1.1 W/m ² K
Max U-value, complete frame and glazing	1.5 W/m ² K	1.4 W/m ² K

PassivHaus Standard

The passive building is, according to the Darmstadt Passivhaus-Institut, a building that achieves a pleasant ambient temperature without conventional heating in winter and without air conditioning in summer.

1. COMFORT AND QUALITY OF LIFE



This performance level is defined by a series of criteria to be achieved by a non-residential building in order to obtain certification:

- Net heating energy requirement equal to or less than 15 kWh/m² per year;
- Net cooling requirement: equal to or less than 15 kWh/m² per year;
- Total primary energy consumption: the total primary energy consumption must be less than 120 kWh/m² per year;
- Air-tightness: the blower door test result must be equal to or less than 0.6 h⁻¹ (air change rate measured at a differential pressure of 50 Pa);
- Overheating frequency: the overheating frequency in the building (>25° C) must be equal to or less than 5% during the working day.

The PHPP (Passive House Planning Package) software must be used to calculate these performances, observing certain rules. With regard to thermal performance of the envelope, these requirements are described by the following coefficients:

Coefficient of thermal insulation	Central Europe	Scandinavian countries - source: Norway (PH recommended)
Max U-value, external walls	0.11 W/m ² K	between 0.10 and 0.12 W/m ² K
Max U-value, roof	0.11 W/m ² K	between 0.08 and 0.09 W/m ² K
Max U-value, ground floor slab	0.15 W/m ² K	0.08 W/m ² K
Max U-value, glazed area of door or window frame	0.8 W/m ² K	/
Max U-value, complete frame and glazing	0.8 W/m ² K	0.8 W/m ² K

School buildings have the following characteristics when compared to other buildings: low occupancy rates and large number of occupants. A large amount of internal heat gain is associated with occupation of the premises, particularly classrooms, and this can cause overheating in well-insulated buildings. Ideally, this should be analysed by dynamic simulation.

Net Zero Energy Building Standard

According to the AIE definition, to meet the Net Zero Energy Building standard, the annual net energy consumption must be compensated by an equivalent amount of energy generated in situ (in the building, over the building and/or its site).

This energy performance level requires both major work to the envelope in order to render it very efficient and a considerable supply of renewable energy (solar, wind power etc.). This input of renewable energy may be produced in situ or in an installation close to the building.

→ Selection and thickness of insulation material according to chosen performance

The choice of a performance level and the thickness of insulation material is to some extent the result of a compromise between reducing operational costs (reducing heating/air conditioning requirements) and the increased investment cost (additional costs generated by thicker insulation).

The thickness of insulation depends upon both the material chosen and its coefficient of thermal conductivity. According to the type of material, varying thicknesses of insulation material may achieve the same insulation performance.

E.g. to achieve the very low energy consumption standard – external walls

- Polyurethane (λ between 0.023 W/mK and 0.029 W/mK): 11 cm – 14 cm;
- Expanded polystyrene (λ between 0.031 W/mK and 0.040 W/mK): 5 cm – 20 cm;
- Rockwool (λ between 0.035 W/mK and 0.040 W/mK): 17 cm – 20 cm;
- Wood fibre panels (λ between 0.04 W/mK and 0.05 W/mK) : 19 cm – 24 cm;
- Cellulose (λ between 0.035 W/mK and 0.05 W/mK): 17 cm – 24 cm.

According to the desired energy performance and the performance of the selected insulating material, the insulation layer of the envelope may thus be relatively substantial.

The weight of this layer may also vary according to the type of insulation material used:

- Polyurethane (30 kg/m³): 3.3 kg/m² – 4.2 kg/m²;
- Expanded polystyrene (25 kg/m³): 3.75 kg/m² – 5 kg/m²
- Rockwool (40 kg/m³ – 100 kg/m³): 6.85 kg/m² – 17 kg/m² with a thickness of 17 cm;

SUSTAINABLE REFURBISHMENT OF SCHOOL BUILDINGS

1. COMFORT AND QUALITY OF LIFE

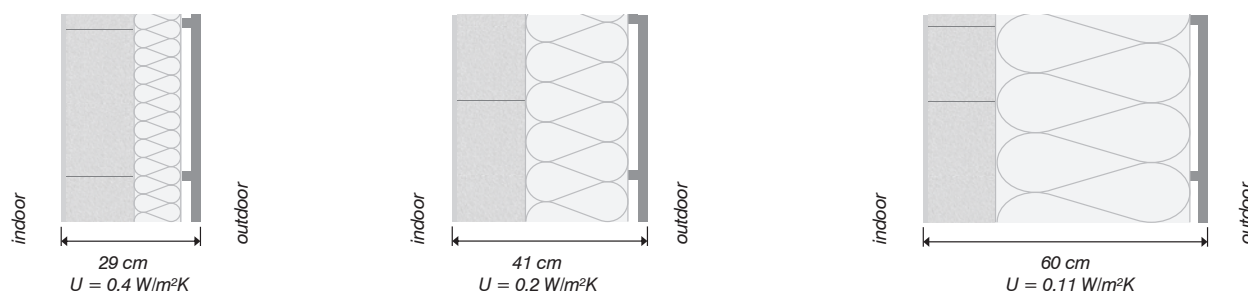

Insulation thickness according to performance achieved

Source: Catherine Massart, *Conception de maisons neuves durables*, Architecture et Climat, 2010

- Rockwool ($140 \text{ kg/m}^3 - 240 \text{ kg/m}^3$): $25 \text{ kg/m}^2 - 43 \text{ kg/m}^2$ with a thickness of 20 cm;
- Cellulose ($50 \text{ kg/m}^3 - 150 \text{ kg/m}^3$): $10 \text{ kg/m}^2 - 30 \text{ kg/m}^2$ with a thickness of 20 cm;

This thickness or extra thickness may have a considerable influence on the construction method and type of fixing possible. Given the thickness of the insulation, the complexity of installation, or the cost, certain construction methods either cannot be used or can only be used with difficulty. Yet, other construction methods encourage or facilitate the use of very thick insulation and also its possible later replacement.

→ Choice of insulation and finish material (interior or exterior)

The choice of insulation materials and finishes is not limited to selection of a construction method. The selection criteria are based as much on their individual and combined performance as on their impacts on the environment or occupant health, their ease of installation and maintenance, their service life and frequency of maintenance as well as whether they can be recycled or, simply, their cost.

→ Choice of construction method

In the case of external insulation, the insulation material will be either stuck or both stuck and mechanically fixed to the support, or else installed between structural elements (timber or metal). It will then be protected by a finishing coat of render or a cladding.

In the case of internal insulation, the insulation material will be either stuck or sprayed, or else installed between structural elements (timber or metal). In the case of internal insulation, it is always best to allow for a rigid lining (2 cm – 10 cm deep) for service runs on the inside surface. This is constructed after installation of the insulation and vapour (and airtightness) membrane and allows setting out cables, pipes or ducts (electricity, heating etc.) without piercing the membrane. The insulation material will, thus, be separated from the internal environment by a rigid lining or a plasterboard or fibre-reinforced plasterboard panel.

The various systems are shown below:

Glued insulation panels

This system is generally the easiest to install, but the existing wall surface (internal or external) must be relatively flat: the surface cannot be more than 15 mm out of true over a distance of 2 m.

Materials

The most frequently used materials are:

- For external insulation: expanded (EPS) or extruded (XPS) polystyrene, polyurethane (PUR), mineral wool or wood fibre panels.
- For internal insulation: expanded (EPS) or extruded (XPS) polystyrene, mineral wool or wood fibre panels;

There are also solutions that combine the insulation material, the vapour barrier and the finish (exterior or interior). In this case, care must be taken to maintain continuity between components. For internal installation, insulating calcium silicate blocks or panels, bonded with adhesive to each other and to the support, may also be used.

Installation

The installation must be carried out very carefully so that the various panels are perfectly jointed and so that the bonds with other panels are also correctly achieved (internal insulation).

SUSTAINABLE REFURBISHMENT OF SCHOOL BUILDINGS

1. COMFORT AND QUALITY OF LIFE



Implementation of EPS - © Sto



Implementation of cellular glass - © Foamglas

Structural system

This system allows adjustment for walls that are out of true or not sufficiently flat. A flexible insulation material is installed within a wood or metal framework fixed to the wall and forming hollow box sections. Loose-fill insulation can also be injected into the framework. The structural elements reduce the insulation capacity of the assembly. To limit this effect, a sheet of rigid insulation material can be applied over the structures:

- For external insulation: before the facing material;
- For internal insulation: before any vapour barrier and the finish.

Materials

Whether for internal or external insulation, the materials most frequently used are mineral wool (MW) or vegetable fibre, or sprayed insulation such as cellulose (CEL).

Installation

Care must be taken with the execution. It must be ensured that breaks in insulation at the structure are minimised. The vapour control membrane must be absolutely continuous.



Implementation of glasswool - © Isover



Implementation of wood wool - © Biofib

Sprayed insulation system (internal)

Some insulation materials can be directly sprayed onto the existing wall. In this case, the wall not being perfectly flat and true no longer poses a problem.

Materials

The insulation material most commonly used is sprayed polyurethane foam (PUR), covered with a render (which provides jointing between panels). There are other options: hemp and lime mixes (LHM), or insulating renders based on expanded polystyrene beads (EPS) or vermiculite etc.

Installation

Successive layers of polyurethane foam are sprayed until the desired thickness is obtained. It dries in a few minutes. Use of hemp and lime mixes is more difficult and takes longer as well as requiring much more time to dry. According to the proportion of binder (non-hydraulic lime-based), hemp and lime mixes may be either directly sprayed onto the support (manually or mechanically), or held against the support by formwork during application. The finish is usually executed using a lime render, which must be absolutely continuous.



Implementation of cellulose flocks - © Thermofloc



Implementation of glasswool flocks - © Isover

→ Financial assistance and subsidies

Insulation of buildings, whether residential or not, is often eligible for subsidies and/or tax relief. It is always useful to investigate before undertaking this type of refurbishment work.

1.3.4.6. Repair, upkeep and maintenance

In some cases, the building to be refurbished is already insulated. In this event, various scenarios can be identified:

- The insulation layer may be inadequate to achieve desired energy performance;
- The insulation layer, vapour barrier or airtightness may have been damaged;
- The insulation layer may both be inadequate and also have been damaged

→ Inadequate insulation

When the insulation to the envelope is inadequate, there are two possible solutions:

- Retaining the existing insulation and adding an additional layer of insulation to enable the desired performance to be obtained;
- Replacing the existing insulation with new insulation.

However, the first solution requires various analyses and simulations in order to be sure that this new layer of insulation will not disturb the hygrothermal balance of the existing wall and lead to deterioration rather than improvement.

Hygrothermal simulation of an existing wall using software such as WUFI, requires knowledge of numerous parameters (types of materials used, their performance etc.). If these are not precisely known, it is better to take the safe option and to remove the existing insulation.

→ Damaged insulation

When the insulation is waterlogged because of water penetration, poor design (inadequate vapour barrier) or poor workmanship (badly installed vapour barrier), it is almost impossible to dry it out completely and naturally, even if the sources of damp have been removed.

Waterlogged insulation is completely ineffective. It is, therefore, necessary to replace it. Its replacement also requires removal of the existing impermeable membrane and installation of new seals.

When damage is due to a defective vapour barrier, the insulation, the membrane and vapour barrier will be replaced by a more effective one.

When insulation has been accidentally compacted, its insulation qualities are reduced in the area of compaction. If the compaction is localised, there is a risk of thermal bridging at that point. If it is not causing surface or internal condensation, its only consequence will be energy loss. However, this will be limited because of the small surface area involved. Before deciding on possible works, one should check:

- whether the insulation is adequate;
- whether the compaction of the insulation layer has caused failure of the waterproof membrane.

If the compaction affects a large area, the thermal quality of the envelope will be seriously reduced. It will then be necessary to replace the insulation, waterproof membrane and vapour barrier.

As a result of shrinkage, thermal movement or external mechanical stresses, insulating panels may shrink or move, thus

creating breaks in the insulation layer.

In those places where the insulation is broken, there will be a thermal bridge. If it is not causing surface or internal condensation, its only consequence will be energy loss. The envelope's thermal quality will be reduced. Before deciding on possible works, one should check whether the consequent level of insulation is still acceptable.

→ Particular attention for flat roofs, after works

Roofs are more vulnerable to damage (water infiltration, compaction of insulation layer, accumulation of leaves etc.).

Flat roofs must, therefore, be maintained to ensure that prompt action avoids any exacerbation of damage, whether to the weather sealing itself, to its support or to the insulation layer, which loses its effectiveness when wet.

This maintenance should preferably be undertaken by the contractor who performed the weather sealing, or by the person responsible for upkeep and maintenance of the school buildings. It comprises:

- after autumn leaf fall, removing dead leaves, moss and debris;
- after the winter, a general inspection and carrying out any repairs relating to the apparent weather sealing, maintenance of gulleys, downpipes, any protective layer, flashings, profiles, joints etc.

1.3.5. Remedying thermal bridges

1.3.5.1. Basic principles

According to Standard EN ISO 10211-1, a thermal bridge is «part of the building envelope where the otherwise uniform thermal resistance is significantly changed by:

- full or partial penetration of the building envelope by materials with a different thermal conductivity, and/or
- a change in thickness of the fabric, and/or
- a difference between internal and external structures, such as occur at wall/floor/ceiling junctions.»

Thermal bridges are design and/or construction defects of a building's insulation envelope. These defects are characterised by a local, linear or point break in the insulation layer. In these places, the surface temperature of the envelope is lower than that of surrounding surfaces. A thermal bridge or its Ψ value is influenced by two types of factor:

- Construction factors: places where continuity of the insulation has not been maintained. As there is a local absence or reduced thickness of insulation, the heat flow is noticeably greater.
- Geometric factors due to the form of the building envelope.

The occurrence of a thermal bridge in the building envelope is a source of:

- **Additional thermal loss**, which can vary between 10% of total heat loss for a building with an average level of insulation, 2/25% for a well-insulated building. These thermal losses inevitably lead to higher energy consumption;
- **Occurrence of condensation** associated with the reduced temperature of the internal skin at thermal bridges. These areas are liable to development of mould, which besides its unpleasant appearance, presents a known health risk to the occupant or user and a risk of premature deterioration to construction materials and components. In very well-insulated buildings, thermal bridges become the only cold spots. They concentrate locally all the risks of condensation and the potential harmful effects associated with it.
- **Occupant discomfort caused by cold wall sensation**. The surfaces in the proximity of thermal bridges have a lower surface temperature than the average of the internal skin.

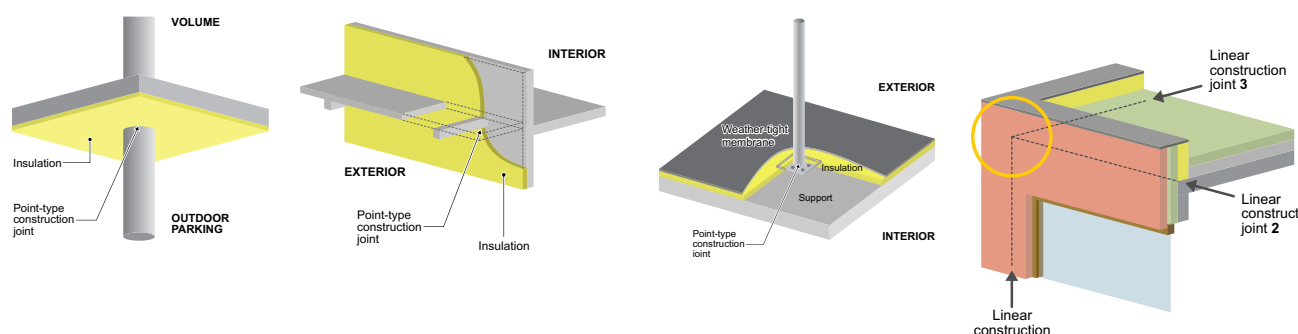

SUSTAINABLE REFURBISHMENT OF SCHOOL BUILDINGS

1. COMFORT AND QUALITY OF LIFE



Thermal bridges of the building envelope are of two types:

→ Linear thermal bridges ψ which extend lengthways

A linear thermal bridge can occur in the following places:

- at the joint of two planes of the heat-loss surface, i.e. at each point where two planes of the envelope intersect or join;
- within a particular plane of the heat-loss surface, where the insulation layer is broken or linearly reduced.

→ Point-type thermal bridges ψ which occur at a specific point

One refers to a thermal bridging point only when the insulation layer of the skin is broken or reduced at a point. This may occur with:

- Columns that penetrate the insulation layer of floor above the external space of a car park, a cellar etc.;
- Beams perpendicular to a wall and that break its insulation layer;
- Fixing points for solar panels, masts etc. that penetrate the insulation layer;
- Anchorage points for masonry supports etc.

1.3.5.2. Stage 1. Detecting thermal bridges

In an existing building, thermal bridging may be identified by visual indicators, e.g. damp patches and mould. However, visual indicators are not always reliable. Therefore, it is strongly recommended – especially if one wishes to achieve the passive standard – to carry out a specific survey, including an exhaustive search for existing thermal bridges. This should use suitable equipment such as thermography (infra-red photography of the building during the heating period), surface temperature measurements etc.

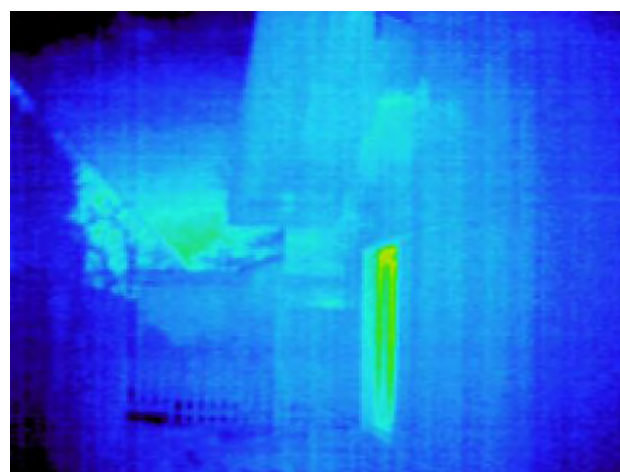
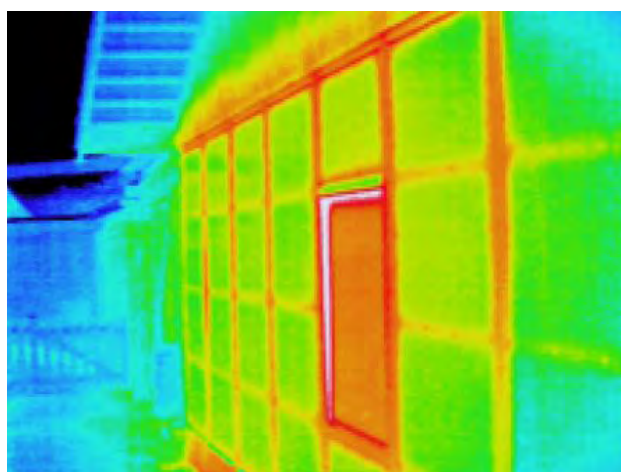

Thermography made before and after the kindergarten renovation - external insulation with rockwool - Kindergarten in Vejtoften (Denmark). Source: Jørgen Rose and Kirsten Engelund Thomsen

1.3.5.3. Stage 2. Assessing thermal loss and condensation risk

Because thermal bridges causes additional heat loss and condensation risk, this heat loss and the potential condensation risk should be assessed.

→ Assessing additional heat loss

Linear and point type thermal bridges are specified by their respective thermal transmittance coefficients: ψ (W/mK) for linear and χ (W/K) for point. For many years, these building vulnerabilities were neglected, but now, especially through Building Energy Performance (BEP) regulations, it is mandatory to take them into account.

To assess these additional heat losses, the architect can choose between several methods:

- the detailed method, which requires numerical calculation of all thermal bridges in the building. This is the most accurate option. The positive or negative effect on levels K and E depends upon the results of the calculations carried out;
- the default method which considers default values (thermal bridging standards or lists). The values will be less favourable than those calculated using computer software.

SUSTAINABLE REFURBISHMENT OF SCHOOL BUILDINGS

1. COMFORT AND QUALITY OF LIFE



→ Assessment of condensation risk

The risk of mould growth and/or surface condensation is assessed on the basis of the temperature factor, observed fR_{si} . Limit values are set for these two parameters – either by reference to the BEP regulations, or by studies of the building's physical properties and the rules of good practice – in order to ensure quality of detailing.

Passivhaus Standard ignores the thermal bridges if their coefficient of lineal thermal transmittance is less than 0.01 W/mK.

1.3.5.4. Stage 3. Remediation of thermal bridging

In refurbishment, increasing the thermal insulation of the envelope can accentuate the relative impact of heat loss through thermal bridging, if this is not remedied. It can prove difficult to make these areas thermally efficient. How difficult this is will depend essentially on the insulation method subsequently chosen.

Certain ground rules are essential to improve or resolve thermal bridging:

- Continuity of insulation

The insulating layers to two adjoining surfaces of the heat loss surface should have a continuous joint with a minimum thickness of contact. Ideally the thickness of contact between the two insulating layers should be the same as the thickness of the layer. However, this ideal solution is not always practically feasible on site.

- Insertion of insulation components when continuity is not possible

In some cases, insulation layers cannot be directly joined to each other. It is then possible to insert insulating components. These insulating components will, locally, take up the thermal insulation function of the insulating layers, so as to maintain the thermal break.

- Length of the path of least resistance

This rule is a provision for when the two previous ones do not enable the thermal break to be assured. The path of least resistance is, strictly, defined as the shortest path between the internal environment and the external or adjacent unheated space environment, and which does not at any point intersect a layer of insulation. If the total length of this path is less than one metre, then it is recommended to add insulation.

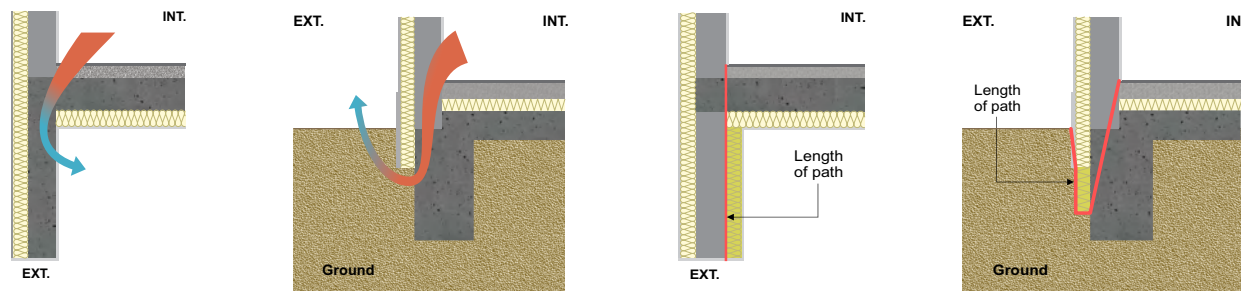

SUSTAINABLE REFURBISHMENT OF SCHOOL BUILDINGS

1. COMFORT AND QUALITY OF LIFE



→ Remediation of thermal bridging for external insulation

Several examples of detailing are shown below, for various joints and connections in the envelope:

	Problems	Solutions
External downpipe		
Door and window frames, lintels and window sills		
Parapet wall		
Ground floor slab		

SUSTAINABLE REFURBISHMENT OF SCHOOL BUILDINGS

1. COMFORT AND QUALITY OF LIFE



→ Remediation of thermal bridging for internal insulation

Several examples of detailing are shown below, for various joints and connections in the envelope

	Problems	Solutions
Electrical sockets and pipework		
Door and window frames, lintels and window sills		
Load-bearing partition wall		<p>Solution 1</p> <p>Solution 2</p>
Upper floor slabs (concrete)		
Timber floor		



→ Useful tools for remediation of thermal bridging

Some specific publications can help designers remedy or mitigate particular thermal bridges. In particular:

- Catalogue des ponts thermiques, SIA, Switzerland
- Bauteilkatalog, Austria
- Les ponts thermiques / Thermal Bridges, B. Quévrin et al (2013), Plate-forme Maison Passive, Belgium

1.3.6. Making the building envelope airtight

Lack of airtightness can make a building uncomfortable both thermally and acoustically (transmission of external noise in urban areas). It also leads to major heat loss and greater energy consumption. Poor airtightness can also affect the proper performance of the heating or ventilation installations.

Air infiltration – associated with this poor airtightness – may involve air movement either from or to the outside (or unheated premises). The former causes energy loss and occupant discomfort, while the latter may also involve the risk of interstitial condensation in the envelope. Such air infiltration is essentially due to weak points in the envelope and their production or elimination must be tackled during refurbishment.

The envelope's main points of vulnerability are located at joinery/glazing units and at the various joins between structural elements.

1.3.6.1. Basic principles

Airtightness is the ability of the building envelope to prevent passage of air between the internal and external environments. Airtightness is an essential factor to be improved if one wishes to achieve good energy performance, ensure structural durability and ensure the efficiency of heat recovery by mechanical heat recovery ventilation (if installed).

Airtightness has several goals:

- reduction of thermal loss (loss through infiltration);
- preventing air transfer through the envelope and the condensation problems arising from it;
- ensuring maximum heat recovery by the mechanical heat recovery ventilation system (if installed).

The level of airtightness of the envelope is assessed by the quantity of air (number of air changes) that needs to be injected to maintain a pressure difference of 50 Pa in the building: n50.

The quality of airtightness depends upon several factors:

- quality of workmanship for installation of vapour barriers and vapour checks;
- type and quality of internal surface coverings;
- quality of external joinery;
- quality of joints or connections between various components (wall/joinery etc.).

→ Regulations

European Standard EN 13779 recommends a maximum air change rate of 50 Pa (n50):

- 1 per hour for high buildings (> 3 storeys);
- 2 per hour for low buildings.

Countries participating in AIE Task 47

Country	Current regulation – renovation of non-residential buildings / schools
Austria	OIB Guideline 6 -Energy saving and heat insulation (new construction): n50<3,0 /h: all buildings n50<1,5 /h: with mechanical ventilation
Belgium	n50 < 3/h : with mechanical ventilation n50 < 1/h : with mechanical ventilation with heat recovery
Denmark	n50 < 1.0 l/s pr. m2 (low energy class 2015 – expected requirement in 2015)

SUSTAINABLE REFURBISHMENT OF SCHOOL BUILDINGS

1. COMFORT AND QUALITY OF LIFE



Germany	<p>Air volume $\leq 1500 \text{ m}^3$: $n_{50} < 3/h$: without mechanical ventilation and $n_{50} < 1.5/h$: with mechanical ventilation</p> <p>Air volume $> 1500 \text{ m}^3$: $q_{50} < 4.5 \text{ m}^3/h$: without mechanical ventilation and $q_{50} < 2.5 \text{ m}^3/h$: with mechanical ventilation with q_{50}: airtightness related to the volume and the envelope area of the building [$\text{m}^3/(\text{m}^2 \cdot \text{h})$]</p>
Norway	<p>Building code (current regulations): $n_{50} < 1/h$</p> <p>NS 3701: $n_{50} < 1.5/h$ (Low energy) or $n_{50} < 0.6/h$ (PH minimum)</p>

1.3.6.2. Stage 1: Checking building airtightness

According to the location of the building or buildings, their airtightness can be tested either by pressurising, or by measuring the residual quantity of a tracer gas previously introduced into the space to be checked.

Another approach is to carry out an individual survey, analysing the finish at window frames, walls, roofs, connections etc.

→ Blower Door technique

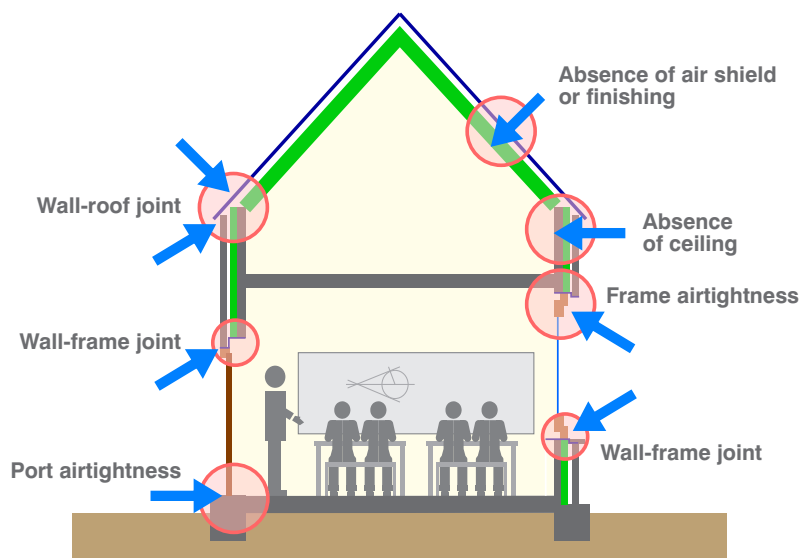

Blower Door Test - Picture: Tatiana De Meester

The quality of a building's airtightness, before or after refurbishment, can be analysed using the blower door technique. This technique consists of pressurising or depressurising the premises, using a fan, and identifying places where air infiltration occurs through the envelope. It is possible to visualise such infiltration using:

- infra-red thermography,
- an anemometer (air flow meter),
- artificial smoke.

The test is carried out under particular meteorological conditions and with all openings in the envelope shut (windows, doors, ventilation grills etc.). A blower is installed in a bay, generally a door, and sealed, to create a pressure difference between the interior and exterior. Leakage airflow rates are then measured for several different pressure levels, with the building pressurised or depressurised. The rate at which the blower has to either extract or input air to maintain a given pressure differential is measured.

For refurbishment, one endeavours to achieve the level required by the Passive Standard, i.e. an n_{50} airtightness level lower than $0.6/h$. However, for low-energy conditions, when the school building is equipped with mechanical heat recovery ventilation, an n_{50} airtightness level of between $1/h$ and $3/h$ is accepted.

1.3.6.3. Stage 2: Design and quality of workmanship on site

Efficient airtightness depends to a large extent upon the quality of the construction documents and the care with which work is carried out on site.

It is, therefore, essential

- to supply the various trades with all the construction details for connections and joints between components;

1. COMFORT AND QUALITY OF LIFE



- to communicate with the refurbishment contractor and the workers, in order that all workers on site understand the usefulness of techniques and devices to be implemented;
- to rigorously monitor the site, especially during installation of vapour barriers and/or vapour checks.

→ Specification of the airtight space

It is essential to establish consistency between the insulated or protected and the airtight space. All insulated surfaces of the envelope must be airtight.

→ Continuity of the airtight envelope

Just like the insulation layer, airtightness must be continuous. It is, therefore, essential to:

- manage all connections with the same material, if it is discontinuous, by the use of adhesive strips (on OSB panels, strips of vapour barrier etc.);
- manage connections between different elements that form part of the airtight envelope (between joinery and walls, between wall components and ground floor slabs, between vapour barriers and plaster finish etc.);
- avoid, as far as possible, openings or interruptions to components of the envelope;
- manage the necessary services openings (chimneys, ventilation, water drainage etc.).

→ Selection of materials and location within the envelope

Airtightness can often be provided by one of the envelope components or materials that already fulfils another purpose.

Airtightness of masonry is generally assured by a traditional internal render, most often plaster-based. Masonry that is only jointed will not, in fact, achieve high levels of airtightness. At the end of works on site, a pressure test combined with infra-red photography (in winter) may be carried out to identify any leaks and to remedy them.

1.3.6.4. Stage 3: Improving the building's airtightness

Before undertaking works to improve the airtightness of the building's envelope, a check should be made that there is a ventilation system installed and that it is in good working order. Without this, improving the building's airtightness could lead to problems of poor air quality, condensation to the external walls of the thermally-insulated space, mould, etc.

Air infiltration may involve air movement either from or to the outside.

The former cause energy loss, but the second can also cause a risk of condensation within the walls when warm, damp indoor air comes into contact with a colder surface of the envelope.

To improve the building's airtightness, it is possible to address different types of heat loss and the airtightness of walls, floors and ceilings separating the thermally-insulated space from the uninsulated space.

With regard to facades, it is thus possible to:

→ Improve airtightness of continuous runs of the envelope skin

It is essential to seal any crack to the continuous runs of the envelope skin of the thermally-insulated space.

Porous construction materials, such as bricks, breeze blocks, mineral wool etc. are air permeable unless a sealing coat is applied.

It can also happen that workmanship to masonry joints may be defective, which increases the air permeability of this type of wall.

To improve the airtightness of the envelope, these materials must be protected with an airtightness layer: a cement-based render or plaster finish, coated plasterboard with correctly sealed joints. A thick coat of film-forming paint may also be suitable.

→ Improve airtightness at joints of facade elements or openings

Junctions, such as joints between the construction elements (facade/roof, facade/floor at skirting etc.) or openings (pipe and cable runs, large windows, doors, roller shutter box, electrical junction boxes etc.) are always vulnerable points.

It is essential to check the tightness of connection joints between the various construction elements or between the skin and openings affecting any layer of the facade that provides airtightness. If such a connection joint has gaps, they must be sealed.



→ Improve airtightness between walls and joinery frames

Retained joinery

For refurbishments where existing joinery is retained, the joint with the wall should be remade.

- Remove the existing seal (mortar or flexible sealant) and clean the opening;
- Insert a joint infill (if the gap is sufficiently large), e.g. by inserting a closed cell packing strip. For solid walls, it is recommended to create an air gap between the external seal with the structure and the internal seal. Injection of polyurethane foam is not recommended, because its expansion can cause damage (tearing etc.).
- Apply a flexible sealant to the joint infill.

Comment: the airtightness of existing frames also needs to be checked if these are conserved.

Replacement of joinery

With regard to the frames themselves, there must be a perfectly airtight seal between opener and fixed frame, as well as between the glazing and the frame. With regard to the joint between frame and wall:

- Joints must always be put in place BEFORE installation of frames. This method is easier, quicker, more economical and guarantees a better result.
- Dry joint to be glued to the vapour barrier of a timber frame, or wet joint to be embedded in the plaster finish in the case of a masonry wall. Extra length should be allowed for in the corners, to allow easy connection with the surfaces of the reveal (see photos);
- Special adhesive joint between frame and panelled reveal. The whole assembly is then installed and joint sealed to the wall (in general, this method is used for timber frame). If the seal must be made after installation of the frame:
- For timber frame: dry joint (often using an adhesive strip) between the frame and the vapour barrier or an OSB/laminated panel, which forms the internal reveal of the bay and is, itself, sealed to the internal vapour barrier;
- For a masonry wall: special membrane glued to the timber and inserted into the plaster finish (N.B. this requires an additional imposed load on the plaster finish, a plasterboard panel or additional batten to conceal the gluing of the connector to the timber);
- The windowsill may be installed with a sealed joint to provide the connection between the wall and the underside of the frame.

→ Continuity of plaster finish if this provides airtightness:

- Plaster finish or sealing membrane in areas inaccessible due to installation of service runs (plumbing, electricity etc.) including ducts.
- Plaster finish to concealed surfaces behind cisterns of suspended WCs;
- Plaster finish to the section of bays adjacent to the facade in hollow masonry partitions;
- Plaster finish to attic, if this is within the thermally-insulated space, even if it is inaccessible;
- Detailing of bottom of wall, joint between plaster finish and slab.

1.3.7. Optimising glazed areas

Windows are extremely important elements of a building and even more so in school buildings, where the quality of illumination is essential to visual comfort, concentration and effective learning.

Windows are elements of the building envelope that fulfil a variety of functions. It is, therefore, important to take these various functions into account when refurbishing school buildings and to achieve an optimum solution and/or compromise between:

- admitting natural light;
- providing a view to the outside;
- thermal performance;
- acoustic performance;
- providing solar gain in winter and protection against it in summer or sunny days in spring and autumn
- option to open windows;
- air and water tightness;
- safety and security.

Windows are also complex elements, made up of various components that will affect how efficiently they function. Their

SUSTAINABLE REFURBISHMENT OF SCHOOL BUILDINGS

1. COMFORT AND QUALITY OF LIFE



orientation, position, design and possible protection will also affect their impact on occupant comfort.

1.3.7.1. Basic principles

While the effect of windows on energy and acoustic performance and on occupant comfort depends above all on their situation (setting out, orientation, position and size of windows), the effect of choice of components is of capital importance.

→ Definitions

A window's heat transfer coefficient U_w (W/m^2K)

This is the amount of energy transferred through the window per hour and per square metre to produce a change of one Kelvin. The smaller the value U_w , the more thermally efficient the window.

The U_w coefficient of the window depends upon several factors:

- the heat transfer coefficient of the frame, U_f ;
- the heat transfer coefficient of the glazing U_g ;
- the characteristics of the spacer, glazing and frame in combination $\square g$;
- the relative proportions of the frame and glazing surfaces;
- the presence of ventilation grilles
- the presence of infill panels (instead of glazing, e.g. breast walls).

Solar factor g-value

The solar factor is the ratio of solar energy entering the building to solar energy incident upon the external surface of the window. As shown in the diagram below, of the total amount of energy incident upon the external surface of the glazing, part is reflected (RE), part is absorbed (AE) by the glazing and part is directly transmitted (TE) to the interior. The part that is absorbed is partially re-emitted to the interior and to the exterior.

The relative size represents the real level of protection from summer overheating provided by the glazing alone, the solar protection alone, or the glazing and solar protection together. The greater the solar factor g , the greater the solar gain.

Light transmittance t_l

Light transmittance t_l is the ratio between the quantity of natural light entering the building through the glazing and the quantity of light incident on the external surface of the glazing. As shown in the diagram below, part of the light incident upon the external surface of the glazing is reflected (RL), part is absorbed (AL) by the glazing and part is directly transmitted (TL) to the interior. The part that is absorbed is partially re-emitted, in the form of heat, to both the interior and the exterior.

The relative size represents the transparency of the glazing. The greater the light transmittance t_l , the more the glazing allows light penetration to the interior of the building.

→ Glazing

The choice of glazing is based on the three parameters defined above. For school buildings, the goal is to minimise thermal loss (the lowest possible U_g) and to maximise provision of natural light (the highest possible t_l) while protecting from solar gain during sunny days in spring and autumn (mainly May, June and September when external temperatures are high). Glazing that allows good energy performance to be achieved is composed of two or three panes of glass, which are held apart by spacers. The glass panes may have an ultrafine, low-emissivity, transparent metal coating and be separated by one or two layers of gas (air, krypton or argon).

For school building refurbishment, in pursuit of the goal of achieving high thermal and acoustic performance levels, the minimum selected would be:

- for central European countries: clear, low-emissivity double glazing with a U_g value of $1.1 W/m^2 K$;
- for Scandinavian countries: low-emissivity triple glazing with a U_g value of less than $1.0 W/m^2 K$.

As applicable, according to the orientation of the facade and the type of premises, one would supplement this glazing with effective solar protection, in order to limit solar gain in the event of overheating.

→ Frames

As glazing has become more and more efficient, the window frame has become the weak point. Particular attention will, therefore, be given to its thermal insulation properties U_f (min. $1.8W/m^2K$). Window frames can be made of various materials. Those most often used are wood, PVC and aluminium.

SUSTAINABLE REFURBISHMENT OF SCHOOL BUILDINGS

1. COMFORT AND QUALITY OF LIFE

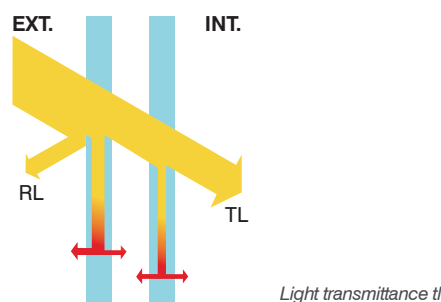
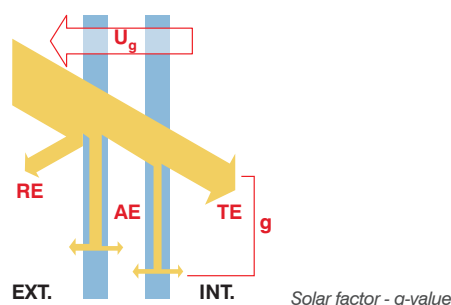

Comment:

For school building refurbishment, a compromise must be found between a high solar factor in winter, a low solar factor in spring and autumn and a high level of light transmittance all the year round. The solution involves choosing clear glazing with a high solar factor and installing solar protection on exposed facades, to prevent overheating in summer.

Wood

Wood is a good material for its thermal performance and technical properties as well as for its environmental properties (abundant, renewable resource, carbon sink, recycling etc.). It has a similar expansion coefficient to that of glass. A wooden frame may have a very long service life if it is well-designed, of good workmanship and well maintained.

There are types of wood that do not require treatment with preservatives or maintenance (high durability). Less durable types of wood can be protected by treatment (maintenance essential) or by a metal capping.

The profile of the frame can be in solid wood, glue-laminated or made up of several different layers including a layer of insulation. In general, profiles of a wooden frame are 58 mm thick, but manufacturers tend to increase the thickness of profiles to improve performance. Thus, some passive frame profiles can be as thick as 120 mm.

Given the number of types of wood available, the designer should be careful to choose timber certified as FSC or PEFC, which guarantee that the wood comes from a sustainably managed forest. The designer should also be careful when choosing preservation and protection products.

PVC

PVC is material much used for external joinery (frames and doors) for the following reasons: good thermal performance, no maintenance, long service life and relatively low cost. Its main disadvantage is its thermal expansion coefficient (higher for dark colours), which makes it difficult to achieve air and water tightness. The environmental performance of PVC is not good, in spite of the fact that it may be recycled.

Aluminium

Aluminium can achieve good thermal performance so long as it has effective thermal breaks. Aluminium frames are solid, have a long service life and require no maintenance. However, they are quite expensive. The environmental performance of aluminium is not good, in spite of the fact that it may be recycled.



SUSTAINABLE REFURBISHMENT OF SCHOOL BUILDINGS

1. COMFORT AND QUALITY OF LIFE



→ Spacers

Spacers are metal or plastic strips that serve to maintain the spacing between the glass panes of the glazing. They cause a thermal bridge around the glazing. Thus, a linear thermal bridging value ψ_g is taken into account when assessing a window's thermal performance. This value depends upon the type of spacer, but also the type of frame and glazing selected. It varies between 0.11 and 0.03 W/mK.

→ Summary table

Frame		Glazing with insulating spacers ($\psi_g = 0.07$ W/mK)					
		Low-emissivity double glazing			Triple glazing		
		air	argon	krypton	argon	krypton	
Type of frame	Uf	Ug = 1.75	Ug = 1.3	Ug = 1.1	Ug = 0.7	Ug = 0.6	Ug = 0.5
PUR	2.80	2.28	1.96	1.82			
PVC	3 rooms	2.00	2.04	1.72	1.58		
	4 rooms	1.80	1.98	1.66	1.52		
	5 rooms	1.60	1.93	1.60	1.46		
Wood Thickness: 58mm	Hardwood	2.14	2.08	1.76	1.62		
	Softwood	1.91	2.01	1.69	1.55		
Metal (aluminium and steel)	20 mm therm. break	2.75	2.06	1.95	1.81		
	30 mm therm. break	2.53	2.19	1.88	1.74		
Passive frame (68 mm – 100 mm) - Wood + insulation and aluminium capping - Wood + cork - PVC + PUR	0.81 to 0.74				0.94 to 0.92	0.87 to 0.85	0.80 to 0.78

Source: Catherine Massart, *Conception de maisons neuves durables – Conception des fenêtres*, Architecture et Climat, 2010

1.3.7.2. Stage 1: Preliminary checks

When refurbishing school buildings, the following must be checked before any improvement work to glazed surfaces:

- The distribution of windows in the facades, according to their orientation;
- The orientation and shape of windows as well as the ratio between the glazed surface and the surface area of the premises they illuminate;
- The condition of the frame and performance of the frame and glazing assembly.

It is important to point out that the quality of distribution of natural light also depends upon the characteristics of the premises to be illuminated (colour and texture of walls and ceilings, furniture, wall hangings or interior blinds etc.), as well as exterior solar protection that can considerably reduce the penetration of natural light to the premises.

→ Distribution of windows

Distribution of glazed surfaces according to the orientation of the facades has a considerable effect upon solar gain as well as on the uniformity and good distribution of light. School premises can be lit in various ways:

- from one direction, when light is admitted from only one of its walls;
- from two directions, when light is admitted from two walls or from one wall and from above;
- from multiple directions, when light is admitted from at least three walls.

When refurbishing school buildings, if possible, light from two directions should be preferred as this allows better penetration and distribution of natural light and reduces backlighting and excessive contrast.

→ Orientation, dimensions and shape of windows

The glazed surface required to provide sufficient, pleasant natural lighting in a room is dependent upon the environment, orientation, position and shape of the window and the room as well as the properties of the glazing, any solar protection, and the internal layout and use of the room (furniture, colour and texture of walls) etc.

Glazed surface

The recommended ratio between the glazed surface and the floor area of the room is as follows:

- 12% to 20% for north-, east- and west-facing premises;
- 15% to 20% for south-facing premises.

Height of lintel

The higher the position of the window, the more deeply natural light penetrates into the room. As an initial check, a room that can be considered well illuminated if the depth of the room is two to two and a half times the height of the lintel above the floor level.

Shape of windows

The wider the window, the better the distribution of light. Moreover, the division of a given surface area of glazing into two or three windows is unfavourable, because it creates areas of shadow. A uniform distribution of light using a single window or glazed surface is to be preferred.

→ Condition of frames and overall performance

The designer will assess both the condition of the frame and performance of the frame and glazing assembly. The condition of the frame is associated with:

- the maintenance and state of preservation (no mould or fungi, no corrosion or deformation);
- hinges being in good working order;
- air and water tightness of seals.

The thermal performance of a frame and glazing assembly is associated with:

- the thermal performance of the glazing;
- the thermal performance of the spacer;
- the quality of workmanship of fixing the frame to the wall (continuity of the insulation).

When refurbishing, in general:

- old frames that are not thermally insulated and not airtight will be replaced;
- single glazing or first-generation double glazing will be replaced with efficient double glazing or even triple glazing.

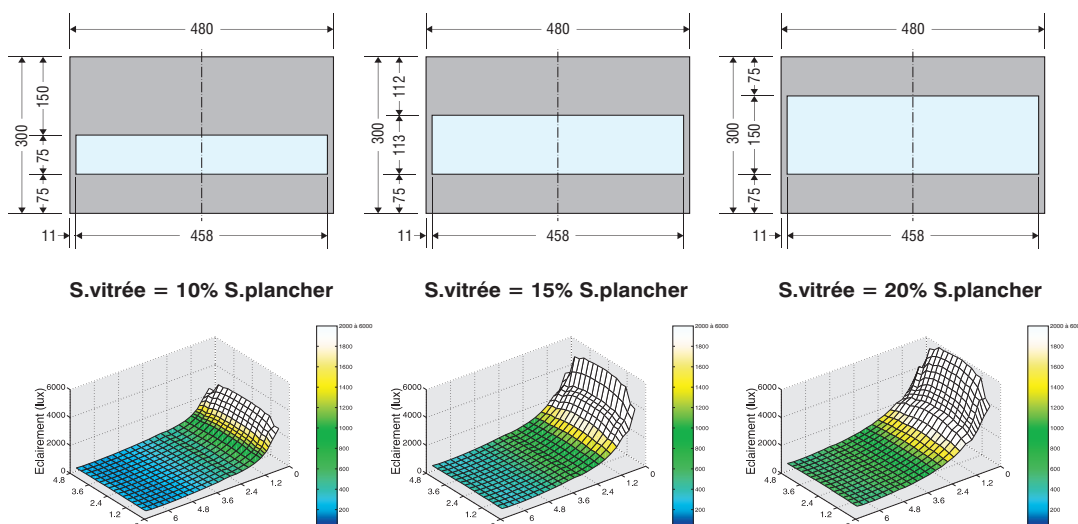

SUSTAINABLE REFURBISHMENT OF SCHOOL BUILDINGS

1. COMFORT AND QUALITY OF LIFE

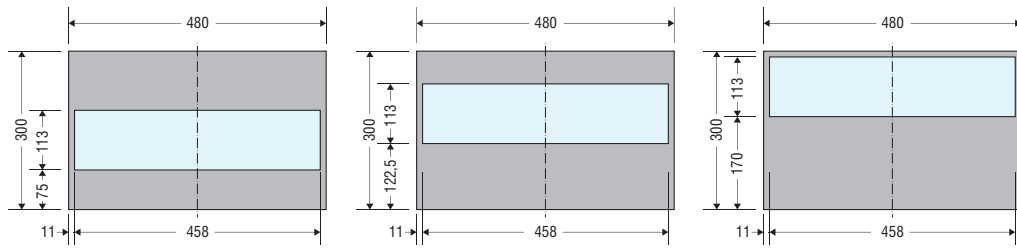

Position basse

Position à mi-hauteur

Position haute

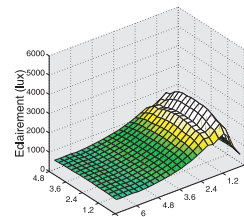
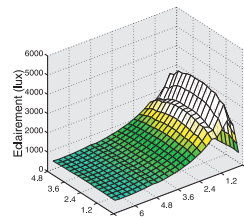
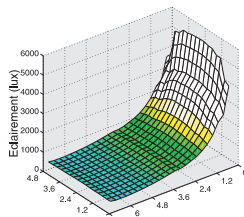

Source: Sigrid Reiter, *L'éclairage naturel des bâtiments, Architecture et Climat, 2004*

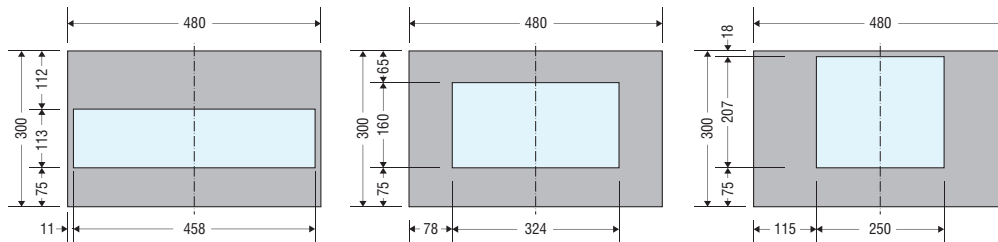

Fenêtre large

Fenêtre intermédiaire

Fenêtre haute

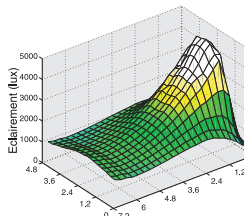
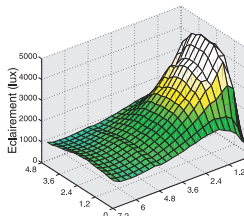
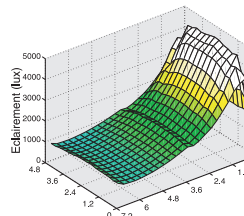

Source: Sigrid Reiter, *L'éclairage naturel des bâtiments, Architecture et Climat, 2004*

1.3.7.3. Stage 2: Refurbishment choices

→ Goals and challenges

Windows are a critical element of the envelope. They often present a surface that is less well thermally and acoustically insulated than the non-transparent surfaces. They can be a source of airtightness defects. They can also be a source of nuisance at certain times of year.

Optimum design or improvement of windows for school buildings should have the following goals:

- suitable size and position for the premises and their use;
- a minimum U_w to limit thermal loss;
- a maximum t_l for optimum natural illuminance;
- a maximum g to allow solar gain in winter;
- effective solar protection to limit solar gain when overheating is a problem;
- good acoustic insulation;
- good airtightness.

→ Refurbishment with changes to bays and new frames and glazing

Following the initial checks, two scenarios may be considered. In the first scenario, it proves worthwhile, given the extent



of works involved, to change, add to or reposition window openings. In this case, all the windows will be replaced. However, it is important to point out that changing a window opening may prove costly, even if it is worthwhile or even necessary in some cases. Other important factors must also be taken into account when carrying out any changes to window openings:

- the aesthetic composition of facades;
- the relation with outdoor areas (playground, green area etc.);
- proximity of highways or open spaces.

→ Refurbishment conserving existing window openings

In the second scenario, it is decided for various reasons to conserve the existing window openings. Two alternatives can then be considered:

- Complete replacement of frame and glazing assemblies, if these two elements are thermally inefficient. In the case of listed or protected buildings, a solution could be a secondary frame and glazing (internal side);
- Conservation of the existing frame, while replacing the glazing, if the frame is in sound condition and thermally efficient. In some cases, a glazed breast wall can be replaced with an opaque, insulated infill (sandwich panel).

1.3.7.4. *Stage 3: Implementation*

When installing new frames in existing or new openings, the designer will pay particular attention to effective airtightness of frame and glazing assemblies, to the airtightness of seals or joints with external walls and to thermal bridges arising from the installation of frames.

→ Refurbishment with changes to bays and new frames and glazing

Alteration of an existing opening will, automatically, involve replacement of the frame and glazing.

→ Refurbishment conserving existing window openings

When conserving an existing opening, there are various possible alternatives for frame and glazing. If the existing frame has poor air and water tightness or poor thermal insulation qualities, it would certainly be worthwhile to replace it. Conversely, if it is air and water tight and provides good thermal insulation, but has only single glazing, replacement of just the glazing may be considered.

In some cases, especially for historic or protected buildings, the existing frame and glazing will be conserved and more efficient, secondary frame and glazing will be installed in the inside.

1.3.8. Solar protection or management of solar gains

In premises with very large areas of glazing and that face east, south or west, solar gain can often be the most important free input.

Remark:

- A west-facing orientation is often the most critical in spring and autumn or in summer, as the solar gain will be in addition to heat stored during the day;
- East- and south-facing orientations can involve problems of glare.

The choice of solar protection varies according to the goals chosen. The main objectives are to limit overheating and glare. Secondary objectives are increasing the insulation performance of windows, providing privacy to occupants or shading the premises.

«Solar protection can, if it is thought out at the beginning of a refurbishment project, be a source of inspiration and an asset for the architectural design of facades. On the contrary, solar protection that is added at the end of design or during the course of works can spoil the aesthetic quality of the facade.»

Source: Catherine Massart, Conception de maisons neuves durables, Architecture et Climat, 2010

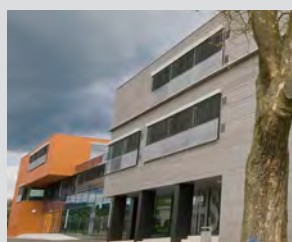

© Petra Blauensteiner



© Atelier Alain Richard



→ Limiting overheating

When the sun shines, the amount of solar energy transmitted through glazing can have a greenhouse effect, leading to unacceptable overheating with adverse effect on occupant comfort. In air conditioned premises, effective solar protection can allow a considerable reduction in the cooling requirement. It is often east- and west-facing orientations that are problematic.

→ Limiting glare

Glare is a visually uncomfortable situation that prevents high quality work and learning. In summer, it is essentially due to the position of the sun early and late in the day in relation to east- and west-facing glazing. However, in winter, there is a risk of glare from south-facing glazing.

1.3.8.1. Useful indices

→ The building's characteristics

Each refurbishment project is different. The desired solar gains are set by the situation of existing buildings, but also by shadows cast by the surrounding built environment and plants. The choice of solar protection, if necessary, also depends upon the characteristics of the building (volumetrics, setting out and orientation of windows, thermal inertia, level and type of ventilation, level of insulation etc.).

→ Solar factor (g-value)

The solar factor is the ratio of solar energy entering the building to solar energy incident upon the external surface of the building (glazed area). The relative size represents the real level of protection from summer overheating provided by the glazing alone, the solar protection alone, or the glazing and solar protection together. The greater the solar factor g , the greater the solar gain.

→ Shade factor

The shade factor is defined as the percentage of opaque surface of a solar protection device. It is the inverse of the opening factor (OF), the size of which is sometimes referred to when describing blinds.



→ Light transmittance

Light transmittance t_l is the ratio between the quantity of natural light entering the building through the glazing and the quantity of light incident on the external surface of the glazing. The relative size represents the transparency of the glazing. The greater the light transmittance t_l , the more the glazing allows light penetration to the interior of the building.

When refurbishing school buildings, solutions are always sought to maximise the light transmittance in order to provide optimum illuminance of the premises.

1.3.8.2. Various forms of solar protection

There are many types of solar protection: permanent protection (special glazing etc.), fixed solar protection (awnings, screen walls etc.), movable solar protection (interior or exterior blinds, shutters, sliding panels etc.).

It is the purpose of this section to suggest guidelines, so that the designer can make the optimal choice according to the orientation and characteristics of the window.

→ Interior or exterior protection?

Exterior solar protection is more effective than interior protection, because it avoids any greenhouse effect behind the glazing. If interior solar protection is chosen, it must be non-absorbent and reflective in order to avoid this problem. Exterior solar protection must be weather resistant and vandal resistant, especially if it is at ground level or at person height. Fixed exterior solar protection is more resistant to mechanical stress.

In some cases, and according to the orientation of the window, it can be worth providing both exterior and interior (interior blind) protection. Solar protection will be useful in spring and summer to protect to the premises from solar gain. In autumn or winter, when outside temperatures are low, interior blinds will allow the advantage of solar gain while limiting the risk of glare.

→ Fixed or movable protection?

It can be useful to have the option of adjusting solar protection if the need for such protection to a facade varies during the day or during the year, because of its orientation. In order to suit requirements, adjustment of movable solar protection can be automated or manual, requiring the occupants to take responsibility for it. Whether or not fixed solar protection is effective will depend upon the orientation of windows and the relative position of the sun during the course of the day or year.

→ Permanent and fixed solar protection

Types of protection	Advantages	Disadvantages
Permanent protection; <i>Solar glazing or films applied to the glazing</i>	<ul style="list-style-type: none"> - Do not obscure the view and have little effect on light transmittance; - Less expensive than an exterior blind; - No risk of breakdown, no maintenance, no need for adjustment; - Easy to install; - No risk of thermal bridging or problems of air or water tightness. 	<ul style="list-style-type: none"> - Permanent protection; - Less effective than traditional solar protection; - More expensive than traditional glazing; - Makes the glass appear reflective or tinted; - Effect on view to the outside (colour rendering).
Fixed solar protection <i>Awnings horizontal, vertical, inclined etc.</i> 	<ul style="list-style-type: none"> - Do not obscure the view and have little effect on light transmittance; - Allow solar gain in winter; - No risk of breakdown, no need for adjustment; - Less expensive than movable protection (upkeep and maintenance). 	<ul style="list-style-type: none"> - Optimal protection only for south-facing facades; - Reduction of solar gain including in winter; - Reduction in natural light; - Risk of thermal bridging when installed; - Maintenance according to the type of material used.

1. COMFORT AND QUALITY OF LIFE

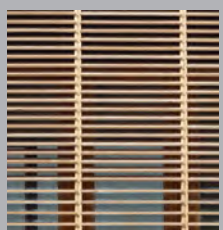

<p>Fixed solar protection Screen wall or fixed element in front of the window</p>  <p>Picture: Catherine Massart</p>	<ul style="list-style-type: none"> - Very effective; - Opportunity for play of light; - Creates some privacy; - No risk of breakdown, no need for adjustment; - Less expensive than movable solar protection. 	<ul style="list-style-type: none"> - Reduces light transmittance and reduces views; - Limited solar gain, even in winter; - Maintenance according to the type of material used.
--	--	--

→ Movable solar protection

Movable solar protection works on the principle that it is positioned in front of the window when there is a risk of sunlight causing overheating and that it is moved or removed when there is no such risk.

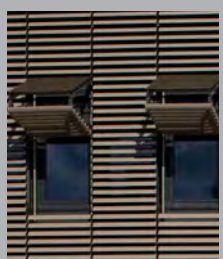
Types of protection	Advantages	Disadvantages
<p>Movable solar protection Exterior roller or slatted blind</p>  <p>© www.renson.be</p>	<ul style="list-style-type: none"> - Adapted to thermal and visual requirements; - Does not obscure the view or reduce light transmittance except when the blind is down; - Allow solar gain in winter; - Easily mechanised or automated, generally by the manufacturer; - Creates some privacy; 	<ul style="list-style-type: none"> - Requires space above the window for installation of a housing (dimensions according to the length of the blind); - Risk of locally reduced level of insulation when housing is installed; - Requires a lateral guidance bar; - Poor mechanical resistance to wind; - Quite high cost; - Requires upkeep and cleaning.
<p>Movable solar protection Sliding or pivoting panels</p>  <p>Picture: Catherine Massart</p>	<ul style="list-style-type: none"> - Adapted to thermal and visual requirements; - Do not obscure the view or reduce light transmittance except when the blinders down; - Allow solar gain in winter; - Major aesthetic impact; - Creates some privacy; 	<ul style="list-style-type: none"> - Requires storage space when the system is not in place in front of the window; - Risk of thermal bridges when installed; - Requires a lateral guidance bar; - The system can be heavy to operate (according to the size of the window).

→ Automating movable solar protection

Most manufacturers of movable solar protection offer automation for it. This automation is usually based upon a sensor for indoor temperature and a sunlight meter. For exterior blinds, wind speed is also measured in order to avoid any physical or mechanical damage. It is not mandatory to automate solar protection. Manual adjustment by the occupants can also be effective, if the latter are aware of the risks of overheating and anticipate them. However, exterior blinds that might get damaged by high winds should preferably be automated.

→ Plant screening

Use of surrounding, deciduous plants can allow adjustment of solar gain according to the season. The usefulness of plant protection is based upon the fact that its annual growth cycle is in harmony with the needs of the building: in summer, the shade provided is refreshing and in winter, the leaves having fallen, sunlight reaches the facade;

Deciduous plants on a south-facing facade have the advantage of:

- providing shade to the facade;
- filtering dust;
- giving protection from hot winds;
- oxygenating and refreshing the air through evapotranspiration.

In addition, the extra space provided for plants noticeably enhances overall occupant comfort: greater visual comfort, improved respiratory comfort, thermal comfort etc.

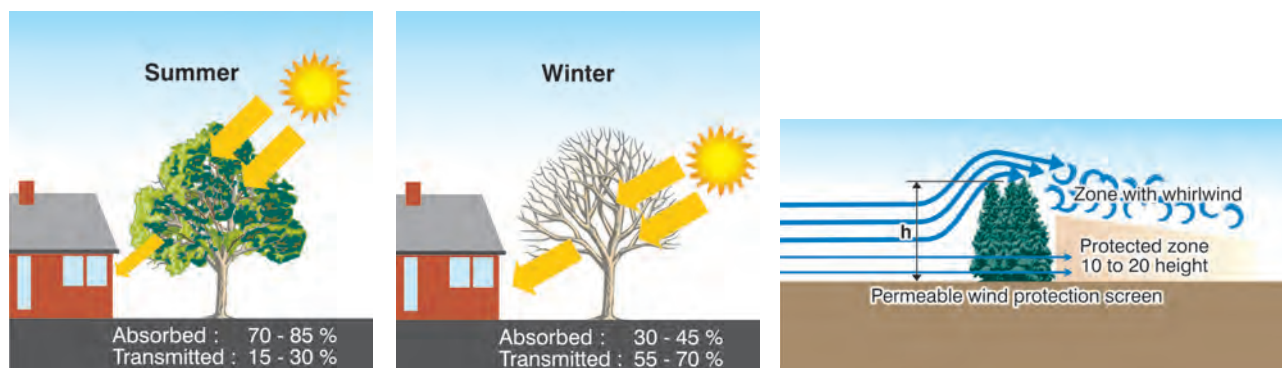

1.3.8.3. Solar protection for refurbishment works

Given the objectives of solar protection, it must be chosen according to the orientation and shape of the window and so as to allow the various parts of the premises to benefit from sufficient natural light.

When refurbishing, before even designing a solar protection system, one should check:

- whether, given the orientation, the window is of an adequate proportions in relation to the area of the premises;
- the properties of the glazing (light transmittance and solar factor).

→ Design

Awnings

The ratio of solar protection depends upon the height of the sun (according to geographical position), the position of solar protection in relation to the window, the relationship between the depth of protection and the height of the window, as well as the dimensions, spacing and orientation of any slats. The g value of a window with an awning varies over time. It can be easily calculated with the free software, Parasol (which can be downloaded on www.ebd.lth.se/english/software/parasol).

External slatted blind

The g-value depends upon the dimensions, spacing, orientation, colour and texture of the material used for the slats. It can be quickly calculated with the free software, Parasol, (which can be downloaded on www.ebd.lth.se/english/software/parasol).

External screen blind

The g-value is independent of the position of the sun. Most manufacturers give the overall g-value for the solar protection and glazing with several types of glazing. This value also takes into account the negative effect of the layer of hot air trapped between the glazing and the blind.



1.3.9. Limiting overheating - thermal inertia in school refurbishment

The thermal inertia of the building, or of a surface of its envelope, represents its capacity to store and, with a time delay, release heat. It depends upon the properties of the materials in relation to the internal climate and the mass accessible to heat gain.

In combination with effective solar protection and intensive natural ventilation, a high inertia enables comforts to be improved in the summer, by limiting overheating during the day. In winter, the capacity afforded by this inertia for storage and gradual release of solar energy allows full advantage to be taken of solar gain and helps regulation of the heating system.

1.3.9.1. *Useful indices*

The thermal inertia of a wall is defined by the thermal and emitting capacity of the various materials of which it is composed.

→ Static properties

Density ρ [kg/m³]

Mass per unit volume of the material. In general, the heavier a material the greater its thermal capacity.

Specific heat C (kJ/kg.K)

The quantity of heat required to raise the temperature of 1 kg of the matter by 1 Kelvin. The specific heat of a material is, thus, its capacity to store heat expressed in relation to its mass.

Thermal capacity C (kJ/m³.K)

The quantity of heat required to raise the temperature of 1 m³ of matter by 1 Kelvin. The thermal capacity of a material is, thus, its capacity to store heat, expressed in relation to the volume of matter.

Thermal conductivity λ (W/m.K)

The amount of heat conducted through a material per 1 m thickness and per 1 m² surface area, with a temperature difference of 1 Kelvin between the two faces of the material. The thermal conductivity of a material is, thus, its capacity to transmit heat by conduction.

→ Dynamic properties

Thermal effusivity E (W/m².K).h^{-1/2})

The rate of absorption of an instantaneous flow of thermal energy (by the surface of a wall)

$$E = (\lambda\rho C)^{1/2}$$

Thermal diffusivity D (m²/h or m²/s)

The rate at which heat is conducted through a material.

$$D = \lambda / (\rho.C)$$

Materials that provide high inertia are thus materials with high density, thermal mass and coefficient of thermal conductivity, or high effusivity.

1.3.9.2. *Physical properties of some materials*

For school building refurbishment, in order to maximise thermal inertia, care should be taken to introduce the maximum amount of mass when choosing second fix and finishing materials. High effusivity materials are the most useful.

The first centimetres of material in contact with the indoor atmosphere have the most impact with regard to inertia. However, mass located deeper than 10 cm from the surface still play a role, even if a lesser one.

SUSTAINABLE REFURBISHMENT OF SCHOOL BUILDINGS

1. COMFORT AND QUALITY OF LIFE



Material	Thermal conductivity λ (W/m.K)	Thermal capacity C (kJ /kg.K)	Density ρ (kg/m ³)	Thermal diffusivity D (m ² / s)	Thermal effusivity E (W/m ² .K) ^{1/2}
Materials in direct contact with the indoor atmosphere					
FLOOR					
Marble	3.5	1.00	2800	16.20	52.17
Belgian blue stone	2.9	1.00	2687	13.99	46.52
Polished concrete screed	2	1.00	2275	11.39	35.55
Porcelain tiles	1.2	1.00	2000	7.78	25.82
Terracotta tiles	0.81	1.00	1700	6.18	19.56
Vynil					
Linoleum	0.17	1.40	1200	1.31	8.91
Timber floor	0.13	1.88	525	1.71	5.97
WALL					
Lime-plaster	0.70	0.85	1600	6.67	16.26
Plaster	0.4	1.00	850	6.10	9.72
Fibre-reinforced plasterboard	0.32	1.10	1150	3.28	10.60
Gypsum plaster-board	0.25	1.00	800	4.05	7.45
Structural materials (behind or under second fix or finishing material)					
FLOOR					
Concrete screed	0.37	0.84	1200	4.76	10.18
Wood particle board	0.15	1.88	600	1.72	6.86
WALL					
Calcium silicate block	1.00	1.00	1750	7.41	22.05
Concrete block	1.07	1.00	1200	11.56	18.89
Terracotta block	0.28	1.00	850	4.27	8.13
Aerated concrete block	0.16	1.00	450	4.61	4.47
Insulation materials					
Wood fibre panels	0.04 - 0.05	2.1	140 - 240	1.03 - 2.2	1.81 - 2.65
Cellulose wool	0.035 - 0.055	2.1	50 - 150	1.44 - 6.79	1.01 - 2.19
Wood wool blanket	0.04	2.1	75	3.29	1.32
Loose cellulose	0.04	2.1	45 - 60	5.49 - 4.11	1.02 - 1.18
Cork					
Rockwool	0.04	1.03	40 - 100	12.58 - 5.03	0.68 - 1.07
Glass fibre wool	0.04	1.03	25 - 50	20.13 - 10.06	0.53 - 0.76
Hemp wool	0.06	1.1	30	23.56	0.74

SUSTAINABLE REFURBISHMENT OF SCHOOL BUILDINGS

1. COMFORT AND QUALITY OF LIFE



Extruded polystyrene	0.028 - 0.038	1.45	38	6.59 - 8.94	0.65 - 0.76
Expanded polystyrene	0.031 - 0.045	1.45	25	11.08 - 16.09	0.56 - 0.67
Polyurethane	0.023 - 0.029	1.4	30	7.09 - 8.95	0.52 - 0.58

Source: Catherine Massart, *Conception de maisons neuves durables, Architecture et Climat, 2010*

In general, for refurbishment, the structural elements (load-bearing walls, floor slab etc.) are conserved. therefore, it is mainly the type of finish is used in refurbishment that will have an impact on improvement of the building's inertia.

The choice of second fix and finishing materials will also have an effect upon acoustics and visual comfort (choice of colours and textures) of the premises as well as upon the environment and people's health. It is, thus, essential for an overall approach to sustainable refurbishment, to find the best compromise between these various factors.

1.3.9.3. Role and impact of inertia

→ Inertia and overheating

Inertia facilitates limitation of overheating by storing some of the excess heat and releasing it gradually and with a time delay. Intense natural ventilation at night, combined with high inertia, allows excess heat to be dissipated thanks to fresh air intake.

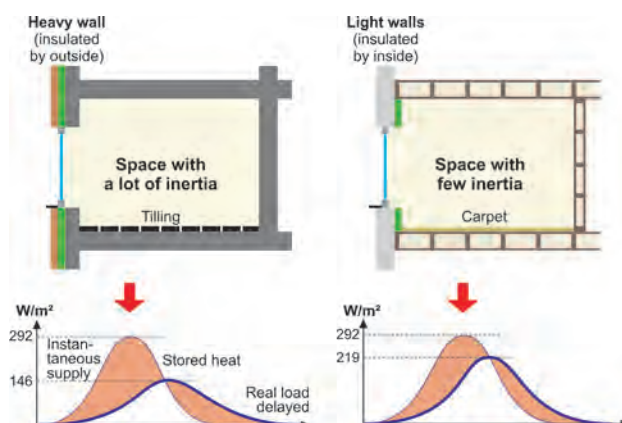

→ Inertia and heating

High thermal inertia allows best use to be made of solar gain and internal heat gain thus reducing the net heating demand. This reduction of net heating requirement is, however, fairly small; though it may become proportionally not insignificant in the case of buildings that have become efficient following refurbishment. High thermal inertia allows easier and more economical regulation of the heating system.

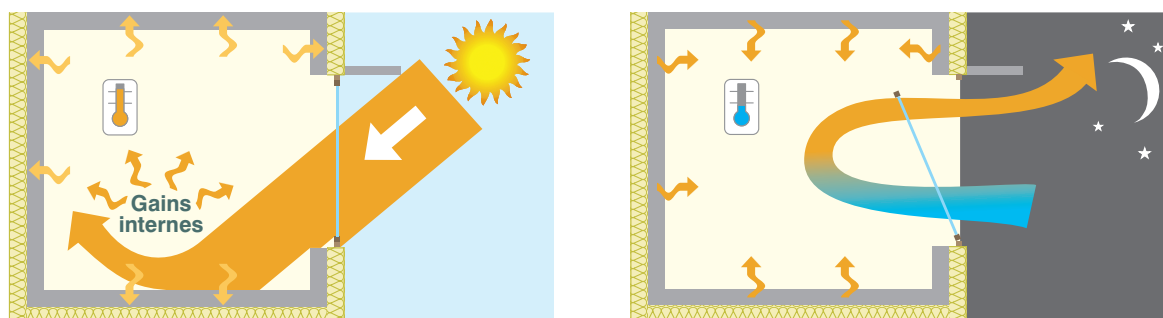

SUSTAINABLE REFURBISHMENT OF SCHOOL BUILDINGS

1. COMFORT AND QUALITY OF LIFE



1.3.9.4. *Increasing the inertia of a building being refurbished*

The heat absorption capacity of a wall or floor depends upon the physical factors mentioned above, but also:

- its colour: the darker a wall or floor is, the better it stores heat;
- its finish or texture: the rougher a wall or floor is, the better it stores heat;
- its position within the room or building: walls and floors that are the most exposed to direct sunshine will have the most effect.

→ **The role of walls and floors**

The walls and floor of a room or premises do not all play an equal role with regard to its thermal environment.

In order to both draw the maximum advantage from solar gains in spring, autumn or winter, while limiting the risk of overheating in summer, it is advisable to increase the inertia of the floor slab and those intermediate floors that receive the greatest part of direct sunshine. If a solution using intense natural ventilation at night is desired, one would try to increase the inertia of all walls and floors.

→ **Increasing the inertia of the ground floor slab**

In general, the ground floor slab is conserved when a building is refurbished. In order to improve the thermal performance of the building, this will be insulated if it was not already insulated.

If possible to do so, it is best to install the insulating layer under the ground floor slab, so as to benefit from the entire thickness of the slab, screed and floor covering.

If this solution cannot be considered, a concrete screed will be installed over insulation and a highly effusive floor covering will be used, such as tiling or natural stone, taking into account its resistance to wear and shock, its colour and texture.

→ **Increasing the inertia of intermediate floors**

Increasing the inertia of intermediate floors means providing them with additional mass, by use of a floor covering, or with a new concrete or dry screed or using ballast (for wood floors). One can also increase the inertia of intermediate floors by using insulating materials with high effusivity, such as wood fibre and cellulose.

→ **Adding new interior partitions and reinforcing existing partitions**

In every refurbishment project, internal partitions are demolished and new ones constructed. If new partitions are being added, heavy partitions should be used (solid block), if the building structure permits.

The mass of existing partitions can also be increased by the use of heavy cladding panels (fibre-reinforced plasterboard in the context of acoustic partitions) or by use of renders with high effusivity.



1.3.10. Dissipating excess heat - refurbishment using intensive natural ventilation

In the context of cooling the building, intensive natural ventilation, known as free-cooling, enables cooling the atmosphere and mass of premises, mainly at night but also during the day. Combined with high thermal inertia, this is a key factor in summer comfort.

1.3.10.1. Basic principles

Natural intensive ventilation comprises cooling a building by ventilation using the free energy of the external air when this is cooler than the indoor temperature.

- In winter, cool outside air can be fed, during the day, into the areas that need cooling, without it being necessary to use an air conditioning system;
- In summer, night-time ventilation can rid the building of heat that has built up during the day.

Intensive daytime ventilation can, thus, be a solution in winter, but is limited in spring, autumn and summer as the difference between indoor and outdoor temperature is not sufficient and requires excessive air change rates. Intensive natural ventilation must not be confused with sanitary ventilation, which provides air replacement necessary to maintain indoor air quality and respiratory comfort. Airflow from intensive ventilation is much stronger: Eight to ten air changes per hour in unoccupied premises and about four air changes per hour in occupied premises, to avoid unpleasant draughts.

Intensive ventilation meets several goals: removing excess heat due to internal and/or solar gain, thermal discharge from the building's mass, improving the feeling of thermal comfort for occupants during the overheating period and the removing pollutants and/or odours from premises that are occasionally heavily occupied.

Intensive natural ventilation can only be implemented under certain conditions:

- when the external environment is not adverse (major noise nuisance, major air pollution etc.);
- the outdoor air temperature must be less than the indoor air temperature – which is always the case at night;

When deciding to use intensive natural ventilation, care must also be taken not to reduce the building's security, by ensuring good anti-intruder protection.

→ Operating principal

The principle of intensive natural ventilation is to create movements of air that allow the building to be refreshed night and day. Two devices are used to achieve this:

Thermal draught or the stack effect

The difference in density between indoor and outdoor air causes a thermal draught, making hot humid air rise and cold dry air fall. This thermal draught can take place within a single room or an entire building. This is known as the stack effect. This system, if it can be installed in an existing building, is the most effective. It allows air replacement at a rate of 6 to 7 vol/h. However it is essential to provide openings for air movement between the rooms and the extract vent. This stack effect can also be assisted by an extract fan. This can be the sanitary extract fan, operating slowly during the day and fast at night. For refurbishment, this solution requires greater changes to the structure of the building (making one or more openings to each floor etc.) and is not always compatible with fire regulations.

Wind

Pressure on the facade exposed to the wind is greater than that on other facades. This pressure difference causes lateral air movement from high to low pressure areas, if the room or the building has openings on two surfaces or two facades. This system allows air replacement at a rate of 3 vol/h. For lateral ventilation to work well, thermal draught and wind effect should not be opposed but, on the contrary, should reinforce each other. Transverse ventilation is only possible if interior doors are left open overnight. Failing this, one could consider installing transfer grilles in doors or small opening windows above them. For this type of cooling to be completely successful, it is essential that occupants are clearly informed about their role in comfort management.

→ Specific features of openings

For both types of design (transverse or stack ventilation), openings used for intensive natural ventilation must provide maximum protection against intrusion, be robust enough to resist high winds and prevent water penetration in the event of storm or heavy rain.

SUSTAINABLE REFURBISHMENT OF SCHOOL BUILDINGS

1. COMFORT AND QUALITY OF LIFE

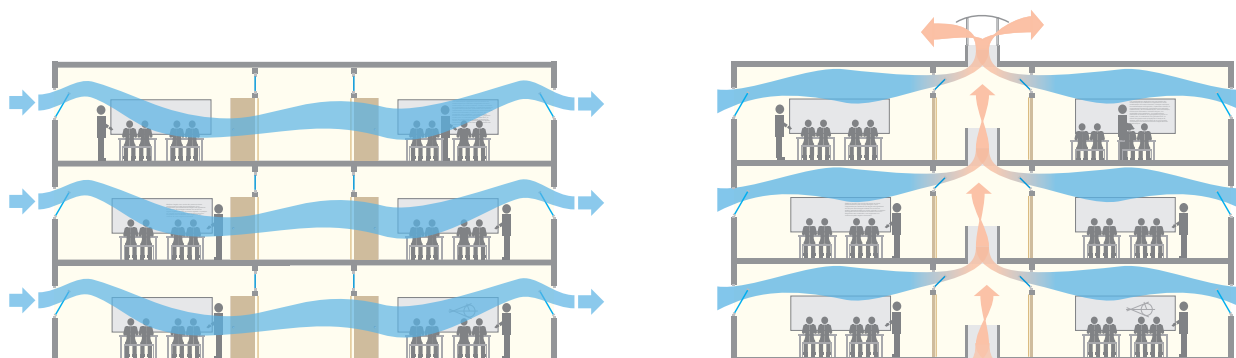

→ Dimensioning

The following parameters must be defined to quantify natural ventilation:

Ventilation flow (m^3/h)

Ventilation flow is the volume of incoming air, equal to the volume of indoor air extracted per hour.

The air change rate (1/h)

The air change rate is the number of times per hour that the volume of air in a room or a part of a building is replaced with outside air. It is the ratio between the total inflow rate (= outflow rate) and the volume of the room or part of the building.

Designing natural ventilation involves designing openings to achieve a particular ventilation flow rate. The ventilation openings must have an area of at least 2% of the surface area of the premises. If they are less than 2%, airflow is insufficient, if they are greater than 2%, they add to the risk of break in.

→ Regulation and automation

Manual regulation of openings may be favoured in order to avoid the cost of automating openings and to raise awareness of teachers and pupils. This will only be effective if teachers and pupils are clearly informed of their role in comfort management and about this type of ventilation. However, for security reasons, we advise against manual regulation for school building refurbishment. In fact:

- Not all school premises are occupied at either the same time, or at the time that windows must be opened or closed;
- In the event of bad weather in the evening or at night, it must be possible to quickly close openings to avoid any damage from wind or rain;
- In mid-season or the beginning of summer, uninterrupted ventilation overnight may excessively cool the building, causing discomfort.

In addition, automation allows the closure of openings to be linked to an electronic alarm, thus reducing the risk of intrusion to unoccupied premises.

Comment:

Internal inputs must be limited to 22 – 26 W/m^2 for a building of average thermal inertia and to 27 – 32 W/m^2 for a building of high thermal inertia. This involves the use of energy-efficient equipment, especially for artificial lighting.



1.4. Optimising the visual comfort in classrooms

1.4.1. Using natural light

Using natural light combines various complementary ideas:

→ Capturing the maximum amount of natural light

Natural light varies in intensity and colour. The amount of natural light penetrating a building depends on numerous factors associated with its geographical position, physical environment and with different times of day and of the year; but it also depends on the types of opening in the building (orientation, slope, dimensions).

→ Transmitting natural light in living and working areas

Transmitting natural light within living and working areas means admitting the maximum amount of natural light by attention to window characteristics (orientation, dimensions, type of glazing, type of solar protection etc.) and to the internal arrangement of rooms (dimensions, internal arrangement etc.).

→ Distribution of natural light in the habitable space

Distribution of natural light involves creating a good spread of light in the habitable space. This harmonious distribution of light will be favoured by the distribution of openings, arrangement of internal partitions and the materials used for internal finishes (floor, walls and ceiling).

→ Control of or protection from natural light

Controlling natural light involves managing its quantity and distribution within a room according to climate conditions, occupant needs and the desired indoor environment to be created. Controlling natural light also involves partially or totally blocking sunlight when it causes particular nuisance to the use of premises. With regard to visual comfort, this essentially concerns protection from glare when the sun is low in the sky and sunlight penetrates deep into the premises. This protection against glare can be achieved mainly by use of interior or exterior blinds.

In the context of school building refurbishment, improving visual comfort means addressing the following factors:

- Providing each room with one or more views of the outside. For classrooms, views of play areas or green areas should be preferred;
- Providing each room with an adequate and comfortable level of illuminance;
- Allowing a harmonious distribution of light and uniform illuminance through suitable choice of windows and internal finishes for the premises;
- Avoiding, as far as possible, glare and/or cast shadows.

1.4.2. Basic principles

This chapter draws heavily upon the theoretical principles of light and natural lighting that feature on the Energie + website (<http://www.energieplus-lesite.be>)

1.4.2.1. Natural lighting and its variants

Natural light varies in intensity and colour. Many factors affect its quantity and quality:

- weather conditions: overcast sky, clear sky or clear sky with sunshine;
- the time of year;
- the time of day: with a clear sky and sunshine, the distribution of light varies strongly according to the time of day and from one part of the premises to another. Available light increases up until midday and then decreases;
- the orientation of openings: orientation, sizing and design of windows are managed according to the sun's path. This is different in the northern hemisphere from the southern hemisphere.

The requirements proposed below may be used for the northern hemisphere:

South-facing openings provide the best situation, since they capture the maximum solar radiation in winter and mid-season, while in summer solar protection is easier because the sun is higher in the sky. The south-facing facade, thus, seems to be the preferred orientation for capturing natural light.

North-facing premises benefit all the year round from even light and diffused solar radiation. During the summer, they can become a source of glare that is hard to control, because the sun is low. It is sensible to have north-facing openings when the premises require even lighting that is fairly constant or diffuse, and this is preferred for certain activities e.g. for painting studios.

East-facing premises have the benefit of morning sunlight, but solar radiation is difficult to manage, because the sun is low in the sky. There is little winter sunlight, but it allows solar gain at the time that the building most needs it. However, in summer, an easterly orientation is more exposed to the sun than a southerly one, which is not very desirable.

A westerly orientation provides direct exposure to the sun in the evening. It is very useful to have the premises facing west if a soft, warm illuminance is desired. Nonetheless, there is a real risk of glare and solar gain tends to lead to overheating. In fact, glazing that is west-facing brings solar gain in the afternoon, when the building has already been receiving it for a long time.

- slope and position of openings (for the northern hemisphere):
- the environment and its characteristics

The available light depends upon the immediate environment of the building through the interaction of various factors: the lie of the land, neighbouring structures, the ground reflection coefficient, vegetation etc. These factors must not be neglected; the presence of a skyscraper, a lake or a tree can radically transform the illuminance of an area.

A solar mask is any body preventing sunlight from reaching a surface that one wishes it to light. In winter, in an urban environment, it is sometimes difficult to capture even a small amount of sunlight because of the screening effect of neighbouring buildings.

1.4.2.2. Basic characteristics of visual comfort

→ Illuminance

Illuminance is the quantity of luminous flux (light) received by a surface. It is measured in lux: $1 \text{ lux} = 1 \text{ lm/m}^2$

E.g.

- an office work surface: 300 lux – 1000 lux;
- outdoor ground with overcast sky: 5000 lux – 20,000 lux;
- outdoor ground with clear sky: 7000 lux – 24,000 lux;
- surface perpendicular to the summer sun: 100,000 lux.

A minimum level of illuminance is necessary to see objects properly and without fatigue and, thus, to correctly carry out various tasks. In classrooms, sufficient illuminance enables good vision that is required by pupils for their various tasks. It facilitates rapid accommodation by the eye for passing from one task to another: reading or writing with a document on a table, reading what is written on the board (black, green or white), reading cards or posters, watching the teacher or another pupil, computer work etc.

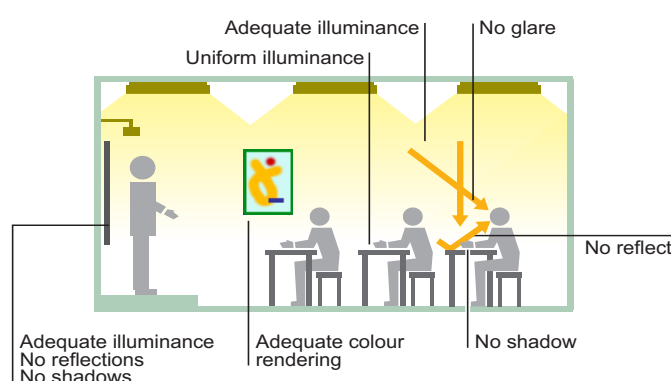

Pictures: Sylvie Rouche

→ Luminance

Luminance is the intensity actually perceived by the human eye. It is the brilliance of an illuminated surface or of a luminous source as perceived by the human eye and is expressed in candelas per m^2 (cd/m^2). It is the most representative measure of the quality of illuminance. It describes the effect of light on the eye.

SUSTAINABLE REFURBISHMENT OF SCHOOL BUILDINGS

1. COMFORT AND QUALITY OF LIFE



E.g.

- Landscape at night: 10-3 cd / m²
- landscape in full moonlight: 10-2 to 10-1 cd/m²
- overcast landscape: 300 to 5000 cd/m²
- moon: 2500 cd/m²
- white paper: approximately 25,000 cd/m²
- sun: 1.5 x 10⁹ cd/m²

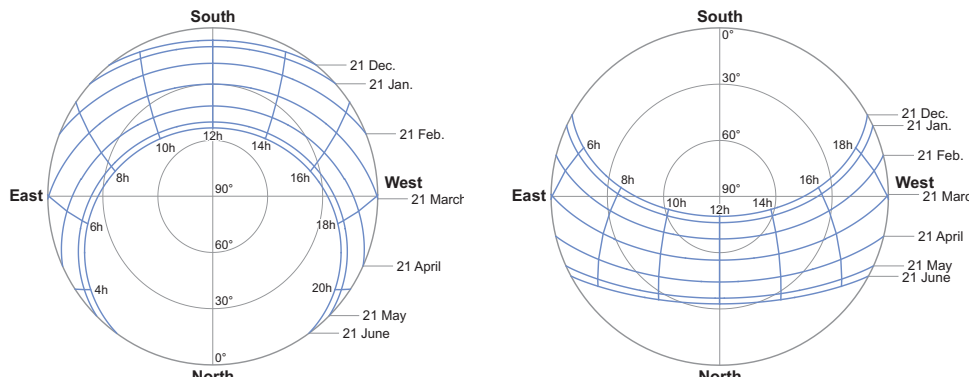

→ Daytime luminance factor (DLF)

With natural lighting, the illuminance requirement can be given as a value of the daylight factor (DLF). This factor is the ratio of indoor natural illuminance at a point (generally the work surface or floor level) to the simultaneous outdoor illuminance on a horizontal surface in a perfectly unobstructed place, with an overcast sky. It is expressed as a percentage. In overcast conditions (standardised by the International Commission on Illumination), daylight factor values are independent of the orientation of glazed openings, of the season and of the time of day.

E.g¹.

- classroom: 2% < DFL < 5%
- corridor: 1% < DFL < 2%

The DLF must be used correctly as it was developed in England, a country that has overcast skies for much of the year. Use of this factor is justified for the countries of northern and central Europe.

→ Daylight autonomy

Daylight autonomy (DA) is defined as the percentage of hours of occupancy per year when the minimum required level of illuminance can be provided by natural light alone.

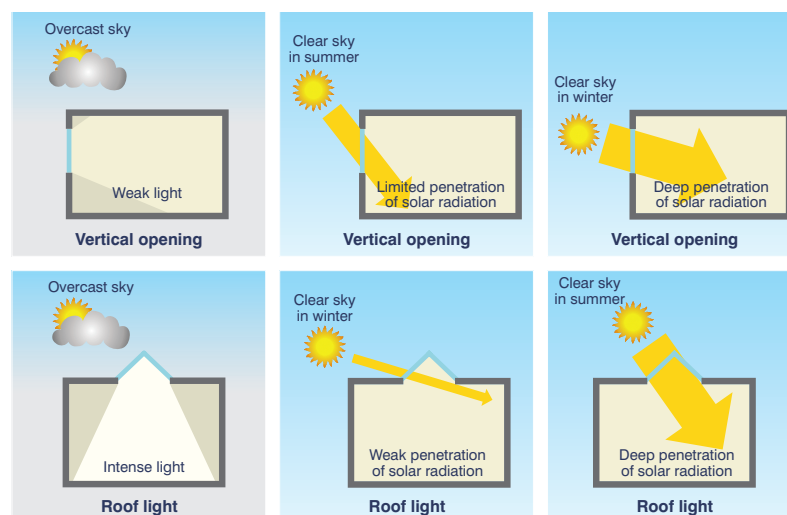

SUSTAINABLE REFURBISHMENT OF SCHOOL BUILDINGS

1. COMFORT AND QUALITY OF LIFE



Use of at least 50% – 60% natural light (for an 8 a.m. to 6 p.m. working day) is a reasonable goal for central Europe countries. 60% daylight self-sufficiency for a workplace occupied from 8 a.m. to 6 p.m. with a minimum illuminance of 500 lux, means that the occupant can, in principle, work for 60% of the year using natural lighting only.

The higher daylight autonomy, the more time the premises are used using just natural light, thus limiting the use of artificial illumination.

→ Distribution and uniformity of light

If the lighting level and luminance vary across the visual field, the eye needs to adapt when its focus moves. Visual acuity is reduced, thus causing eye fatigue. Distribution of luminance or uniformity of illuminance levels describes variations in the illuminance level and is defined as being the ratio between minimum and average illuminance observed in the work area.

Recommended uniformity according to the type of work to be performed:

Uniformity for the work area varies from 0.4 to 0.7 according to the nature of the task performed.

Examples taken from Standard EN 12-464-1 (2011):

- Circulation areas: 0.4 uniformity
- School stairs: 0.4 uniformity
- Classrooms: 0.6 uniformity

→ Colour rendering

Every light source, whether natural or artificial has its own unique light spectrum. Natural light, from sunlight and the sky, has a continuous visible spectrum (light with a wavelength between 380 and 760 nm). The mixture of wavelengths making up this spectrum form, by definition, what is known as white light: this is the only light that allows the eye to perceive the colour of objects and their most delicate nuances, with the greatest precision.



Colour rendering - Picture: © Verlichting in scholen», Vlaamse overheid



Glare - Picture: Catherine Massart - Coralie Cauwerts

→ Glare

Glare is due to the presence, in the field of vision, of excessive luminance (intense light sources) or excessive contrasts of luminance in space or time.

According to its origin, glare can be divided into direct or reflected glare.

Under natural light, glare can be caused by a direct view of the sun, by an excessively luminous sky seen through windows, or by walls or ceilings that reflect sunlight too strongly and cause excessive contrast in relation to adjacent surfaces. It is worth noting that a larger opening to natural light causes less glare than a small one, because it increases the level of adaptation of the eyes and reduces luminance contrast.

→ Shadows

According to its direction, light can cause the appearance of strong shadows, which risk disturbing the performance of work. Because of its direction and spectrum, lateral penetration of natural light generally give satisfactory three-dimensional perception of objects' relief and colour. This is the ideal case, but the level of illuminance diminishes with distance from the windows.

→ Light transmittance through glazing

When visible sunlight is intercepted by a wall or ceiling, part of the light is reflected (RL) To the outside, part is absorbed



(AL) by the materials and parts is transmitted to the interior. The percentage of light transmitted is called the light transmittance (LT).

→ Particular properties of rooms

The volumetrics of premises and the properties of its walls and ceiling affect the quality of distribution of the luminous flux. They constitute the immediate or distant environment. The luminous flux in a task area is the result of the combined effect of natural light from an opening in the external vertical and/or horizontal skin and artificial light.

1.4.3. Optimising visual comfort in classrooms

In the context of refurbishing school buildings, optimising visual comfort means addressing the following parameters in order to maximise luminance comfort and the use of natural light in classroom premises:

- Providing each room with one or more views of the outside. For classrooms, views of play areas or green areas should be preferred;
- Providing each room with an adequate and comfortable level of illuminance;
- Allowing a harmonious distribution of light and uniform illuminance through suitable choice of windows and internal finishes for the premises;
- Avoiding, as far as possible, glare and/or cast shadows.

1.4.3.1. Assessing the quality of premises' illuminance

Before undertaking refurbishment works or changes to internal layout, those things that need to be optimised should be identified through analysis of the lighting environment or the quality of illuminance of the premises and by assessing its comfort level.

The luminance level can be assessed using a light meter at different places in the room: teacher's desk, blackboard and various pupils' desks.

The steps to be followed are set out in the appendix of the publication «Code de Bonne Pratique en Eclairage Intérieur» [Code of good practice for indoor lighting], which may be downloaded from http://www.cstc.be/homepage/download.cfm?dtype=publ&doc=IBE-BIV_Code_de_bonne_pratique_12464_1.pdf&lang=fr

The recommended illuminance level is between:

- 300 lux and 500 lux for the desk or work surface;
- 500 lux for the blackboard;
- 300 lux for other areas in the classroom.

The recommended daylight factor (DLF) is between 2% and 5% .

Attention should also be paid to the colours of surfaces, the colour of the blackboard or whiteboard, to the surface, position and shape of windows and to any obstruction of windows by wall hangings or display panels.

The lighting environments offered by the refurbishment project can also be evaluated by computer simulation, using specific software, or by use of a scale model.

1.4.3.2. Classroom type and layout

Guidelines can then be proposed according to the classroom type and layout, the proportion of glazed surface, the geographical position of the premises and their orientation.

We have based our thinking on the three types of classroom shown below.

Type 1: external space – classroom – circulation area – external space

- Suitable glazed surface for the room and its depth;
- Choice of glazing;
- Choice of internal layout (surface colours, choice of furniture, choice of blackboard or whiteboard);
- Creation of an opening (at high level) between the classroom and the circulation area;
- Consideration of solar protection according to orientation.

Type 2: external space – classroom – circulation area – classroom – external space on a single level

- Suitable glazed surface for the room and its depth;

SUSTAINABLE REFURBISHMENT OF SCHOOL BUILDINGS

1. COMFORT AND QUALITY OF LIFE



- Choice of glazing;
- Choice of internal layout (surface colours, choice of furniture, choice of blackboard or whiteboard);
- Creation of an overhead opening in the circulation area;
- Creation of an opening (at high level) between the classroom and the circulation area;
- Consideration of solar protection according to orientation.

Type 3: external space – classroom – circulation area – classroom – external space, on several levels

- Suitable glazed surface for the room and its depth;
- Choice of glazing;
- Choice of internal layout (surface colours, choice of furniture, choice of blackboard or whiteboard);
- Consideration of solar protection according to orientation.

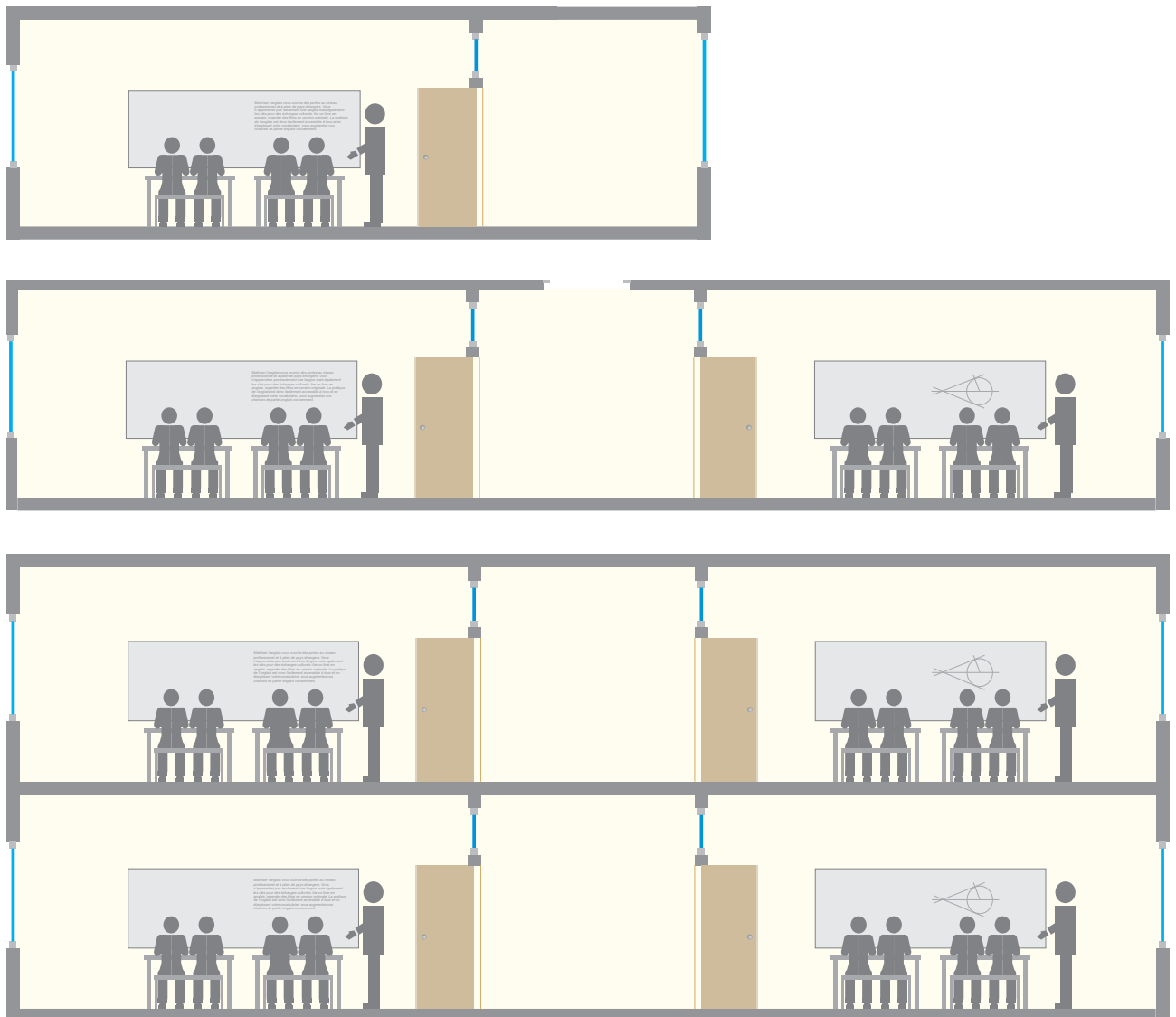

1.4.3.3. Improving natural light in premises

→ **Optimising the glazed surface, shape and properties of components**

For refurbishment, when the illuminance level is inadequate, it can be a good idea to increase the area of windows in order

SUSTAINABLE REFURBISHMENT OF SCHOOL BUILDINGS

1. COMFORT AND QUALITY OF LIFE



to maximise the quantity of light in the premises. Yet, considerations of thermal comfort and energy efficiency favour limiting the area of glazing. To provide a good compromise between thermal loss and quality of natural light, the net illuminant surface of a room should be no less than 20% of the floor area, with windows ideally situated; i.e.

- windows situated as high as possible, without glazed breast walls and providing a view of the outside;
- wide windows, minimally divided (a single wide window rather than several narrow windows).

→ Optimising the choice of glazing if frames are replaced

If frames or glazing are replaced, glazing will be chosen that provides maximum light transmittance:

- clear, low-emissivity double glazing: 78% light transmittance;
- clear triple glazing: 74% light transmittance.

→ Optimising the layout or interior design of the premises

The layout can have a strong effect on the lighting environment and visual comfort. It should, therefore, be optimised.

Surface colour

The darker the internal skin, the greater the difference will be between lighting levels in the room. For refurbishment, one should:

- prefer light coloured finishes that make the room more luminous;
- reduce contrasts of window and joinery by increasing the reflection coefficient of the joinery and choosing a light wood or light colour paint.

For surfaces of walls, floors and ceilings, particular reflection coefficients can be recommended:

- ceiling: 0.7 to 0.85
- wall close to light source: 0.5 to 0.7
- other walls: 0.4 to 0.5
- floor: 0.1 to 0.3
- desktops: 0.4 to 0.5.

Blinds and curtains

Curtains, blinds or net curtains are essential to provide privacy to the room and limit the risk of glare. But these can reduce light transmission. Therefore, it is essential to integrate the space taken up by curtains or blinds when designing openings to facades.

Blackboard or whiteboard

Attention should also be paid to the type of board installed in classrooms: white and shiny or black/green and matt. Whiteboards are more and more frequently used in schools but can cause glare discomfort.

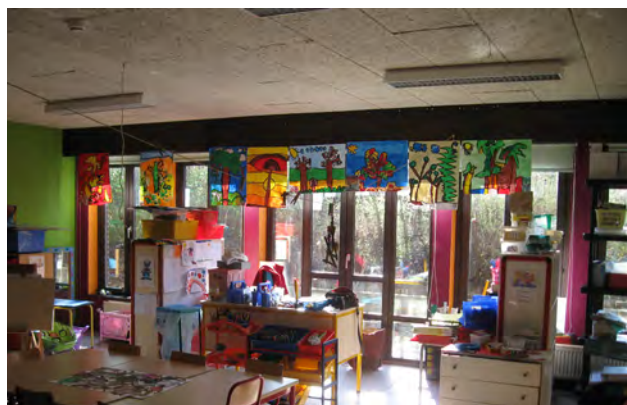

Picture: Catherine Massart - Coralie Cauwerts



Picture: Sylvie Rouche

Furniture layout

As seen in the plan shown below, three zones can pose a problem for furniture layout.

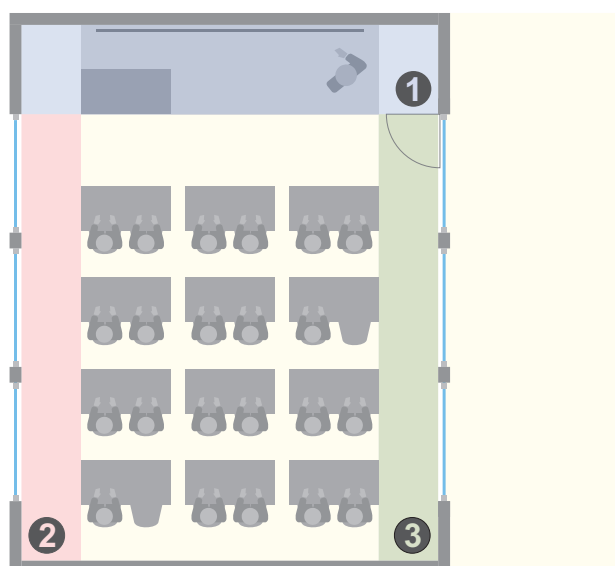

Zone 1

The area around the board, ideally without directly incident light;

Zone 2

The area located along the windows to a depth of about one metre. Ideally no desks should be located in this area, in order to avoid problems of glare. This area can be used for low storage, the length of the breast walls.

Zone 3

The area along the partition wall to the circulation area, usually darker. This area can be used as a storage area: shelving, cupboards, lockers etc.

Ideally, tables and desks should be situated in the middle of these three zones.

→ Optimising solar gain while limiting glare (northern hemisphere)

The quest for natural light can entail thermal discomfort, particularly in summer. However, the addition of solar protection can also seriously reduce light transmittance. Solutions should be distinguished according to orientation.

North-facing classroom (north-west to north-east)

Solar protection (fixed or movable) is not advised. North-facing rooms benefit all the year round from even light and diffused solar radiation. Conversely, these are the rooms where solar gain is most appreciated.

East-facing classroom (north-east to south-east)

A combination of interior and exterior protection is best. These premises benefit from the morning sun which:

- in winter, provides solar gain, which helps with heating in the morning. Movable, interior solar protection allows limitation of glare while retaining this solar gain;
- in summer, movable, exterior solar protection enables both limitation of glare and the benefit of solar gain.

West-facing classroom (south-west to north-west)

Movable, exterior solar protection is the best solution. A westerly orientation tends to lead to more overheating. In fact, glazing that is west-facing brings solar gain in the afternoon, when the building has already been receiving it for a long time.

South-facing classroom

Awning-type fixed solar protection is thermally effective and more robust than movable protection. Therefore, this is to be preferred. However, care must be taken that this does not excessively reduce natural lighting, e.g. by giving preference to awnings made up of an arrangement of louvres, rather than a solid panel.

→ Maintenance of glazed surfaces

The maintenance of glazing has an important impact on light transmittance. Regular cleaning is, thus, important. It is, therefore, important when carrying out sustainable refurbishment, to take account of the need for access to all glazed surfaces.

Comment: self-cleaning glazing is available, which enables cleaning to be performed less frequently, though some cleaning is still necessary.



1.4.3.4. Provision of artificial lighting

For a sustainable refurbishment approach, use of natural lighting is preferred to artificial lighting. The spectrum of natural light as well as its variety and nuances offers optimal perception of form and colour. It is essential for visual comfort and the quality of children's learning. Artificial lighting should, therefore, be considered as additional to natural lighting. This addition proves necessary at some times of year and so must be optimised both by the choice and the location of light fittings and by their management, so as to limit their use but also reconcile visual comfort and energy efficiency.

This issue is addressed in Section 2 « Services and Energy Efficiency».

1.5. Optimising the acoustic comfort in classrooms

1.5.1. Basic principles

Before proposing solutions for improvement of acoustic comfort in school classrooms, it is important to recapitulate the subject of building acoustics. Building acoustics essentially deals with the two following phenomena:

- Acoustic insulation, intended to protect occupants of the premises from noise generated within the building (airborne noise, impact noise from adjacent premises or equipment noise) and also against external noise nuisance;
- Acoustic correction, intended to provide a harmonious correction to sound reverberating within premises.

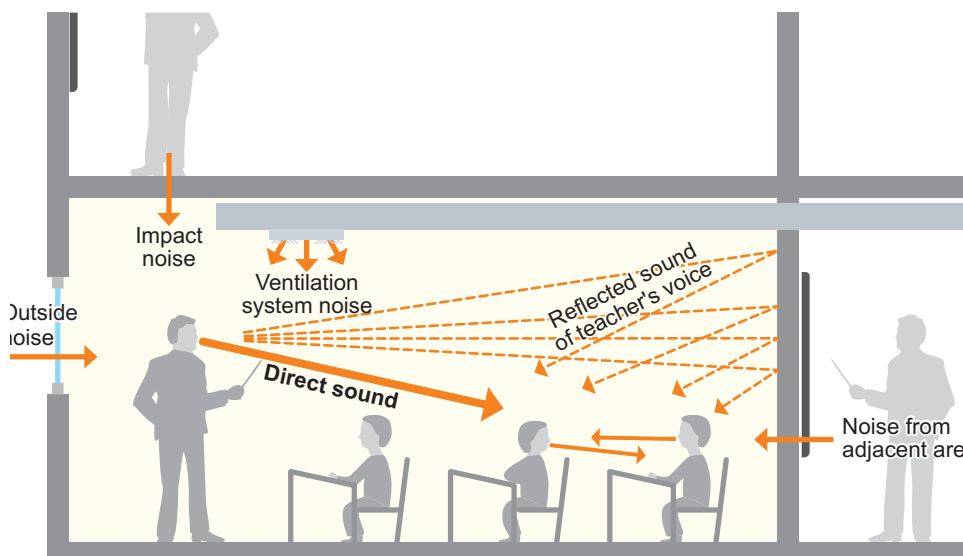

Pictures: Sylvie Rouche

1.5.1.1. Sound and noise

Sound is an auditory sensation caused by the vibration of a solid body that causes periodic fluctuation in air pressure at the eardrum. This variation of pressure is represented as a sine wave that spreads in all directions from the source and at speeds that vary according to the propagating medium (air, water, solid). The speed of propagation of sound is 340 m/s at a temperature of 15° C. Sound propagates faster in summer.

A pure tone is a vibration in an elastic medium, characterised by its frequency or its pitch and amplitude or by its intensity. Noise is a complex mixture of pure tones at many different frequencies and amplitudes.

There is no physical difference between sound and noise. The difference is only subjective; noise is generally associated with any disturbing, unpleasant and undesirable auditory sensation.

→ The pitch of sound

The pitch or frequency of a sound is defined by the number of vibrations per second. Frequency differentiates high-pitched from low-pitched sound:

- Low pitch or low-frequency sound (frequency of less than 100 Hz);
- Medium pitch or medium frequency sound (frequency of between 100 Hz and 2000 Hz);
- High pitched or high-frequency sound (frequency greater than 2000 Hz).

For building acoustics, a range of frequencies lying between 100 Hz and 5000 Hz is considered. The sensitivity of the middle ear ranges from 20 Hz to 20,000 Hz.

→ Intensity of sound or noise

The intensity of sound, or noise level, is given in decibels dB. The decibel is a logarithmic scale of measurement, because the human ear has an ultra-sensitive response to stimulus.

Weighted decibel measurements A^2 , dB(A) better reflect the ear's differential perception of frequencies. The sensitivity of the ear and the pain threshold vary according to frequency. It is higher for mid-range and high frequencies than for low

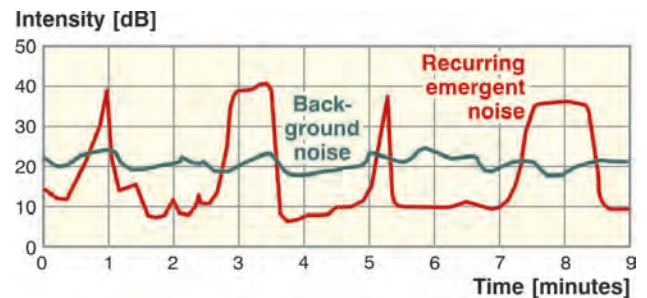
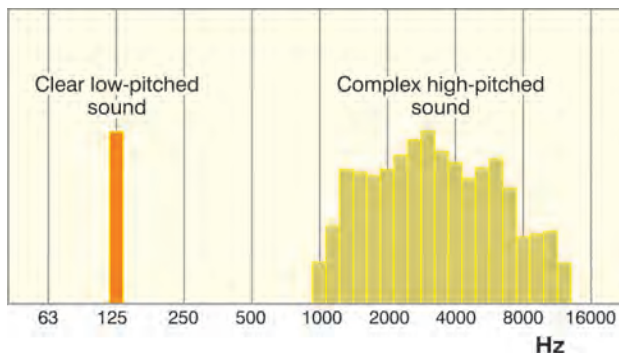

or very high frequencies. Sound levels varying over time are quantified by the equivalent continuous level during a given period, called the L_{Aeq T} sound level equivalent in dB(A) during time T.

→ The mathematics of sound

As the decibel is a logarithmic measure, addition, subtraction and multiplication of sound levels is not arithmetic.

Reducing the sound level by half is equivalent to reducing it by 3 dB; however, it is difficult to differentiate between two environments where the sound level differs by only 3 dB. In reality, a reduction of 10 dB is needed for the emitted sound to be perceived as half as loud.

1.5.1.2. Noise perception – acoustic comfort

Sensitivity to noise varies from one individual to another and is not always predictable. A pleasant or unpleasant acoustic environment in a living or working area revolves around three concepts: the noise source, the way noise is transmitted and noise reception.

→ Emergence

Emergence is the amount of noise that exceeds the ambient sound level. The disturbance caused by emergence does not only depend on the sound level, but equally on the relationship between the ambient sound level and the level of emergence noise.

→ Personal sensitivity

Whatever the source and origin of noise, our ears perceive vibrations in the area and our brain interprets these stimuli. However, the same noise will be perceived differently by two different people.

In fact, the perception of noise depends very much on the state of health of the person (fatigue, stress, illness etc.) and their acoustic environment (facing a green area or the length of a busy arterial road etc.).

1.5.1.3. Types of noise

Sound or noise is characterised by its mode of propagation: impact noise, where sound is propagated in hard materials, and aerial noise, where sound propagates in the air. In building acoustics, three types of noise are distinguished:

→ Airborne noise

Airborne noise is generated by interior or exterior sources that are not in contact with any structural elements. The acoustic vibrations arise in the air and propagated through it.

E.g.

- Interior airborne noise: noise of voices, conversation, music etc.

- Exterior airborne noise: road traffic noise, aeroplane noise, noise of children in the playground etc.

→ Shock or impact noise

Shock or impact noise is generated by sources connected to the building's structure or that violently hit it. The vibrations take shape within the structure when there is a more or less violent shock. The noise is emitted by an element of the building skin vibrating.

E.g. falling objects, slamming doors, noise of footsteps etc.

→ Equipment vibration or noise

Equipment noise is made up of airborne noise and vibration. Some vibration is directly emitted and transmitted via supports (walls, floors etc.) and other vibration via the air, according to the orientation and direction of its source.

E.g. noise from toilets, heating, ventilation, electrical equipment etc.

1.5.1.4. Propagation of noise



Propagation of sound or noise is the path followed by the waves emitted by the sound source for them to reach our ears. The speed of propagation depends upon the environment within which the sound or noise is emitted; in air at a temperature of 15° C, the speed of propagation is 340 m/s. When sound impacts an element of the envelope (floor, wall or ceiling), three phenomena can be produced (see picture next page):

- noise transmission through the envelope (3);
- reflection or reverberation of the noise on the envelope (2);
- absorption of the noise by the envelope (4).

→ Noise transmission

Whether it is airborne or transmitted by vibrations, noise propagates within the building by way of a more or less complex path between the source and the occupant's ears. On its way through the building, noise can encounter obstacles but will attenuate its intensity or, on the contrary, acoustic bridges (holes in the structures) which will allow it to propagate more easily. Sounds are transmitted:

- by direct transmission (DT): through a separating surface of the envelope (wall, floor or ceiling);
- by indirect or lateral transmission (LT): through envelope skin elements other than the separating one;
- by parasitic transmission (PT): through localised airtightness defects;

→ Reflection of noise

When noise meets an element of the envelope skin, part of that noise is reflected by it. This reflected noise then mixes with the noise emitted in the room. The phenomenon of noise reflection is greater insofar as the envelope skin is composed of heavy, rigid and smooth elements.

→ Reverberation time

The reverberation time (RT) of a room is the time, expressed in seconds, required for the noise level to reduce by 60 dB after the noise source stops emitting. Reduction of reverberation time of premises generally involves reduction of the ambient sound level in those premises. The reverberation time varies according to the characteristics of the premises: volume, geometry and finishing materials. Longer reverberation time causes greater perception of an echo effect, the room is noisier and speech is less intelligible.

The level of acoustic absorption required to obtain a given reverberation time can be quickly estimated using Sabine's reverberation time (RT) equation:

$$A = 0.161 \times \text{volume} / \text{RT}$$

where volume is expressed in m³.

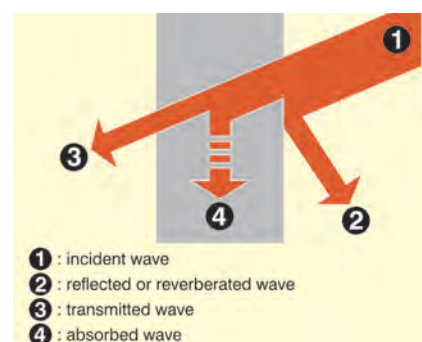
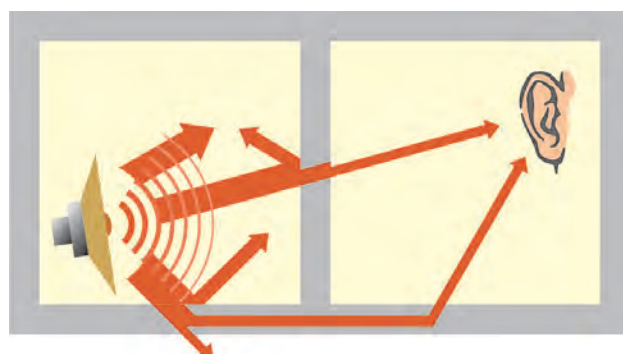

When a teacher talks in a classroom, the pupil hears a combination of the sound directly emitted by him and multiple reflections of that sound from different surfaces. Some of this reflected sound reaches the listener almost immediately after the direct sound, hereby increasing the voice's intelligibility. Conversely, reverberated sound arriving more than 0.5 seconds after the direct sound has a telescope effect on it and reduces its intelligibility. The opposite also holds: if the room has insufficient reverberation, the teacher's voice does not carry. Therefore, both excessive and inadequate reverberation time inhibit good intelligibility and comprehension of the teacher's voice.

The reverberation time of a room should, ideally be between 0.5 and 0.7 seconds. It is also recommended that the reverberation time should be no less than 0.4 seconds, as that also may be a source of discomfort (insufficiently reverberant environment).

1.5.2. Acoustic insulation and correction

1.5.2.1. Acoustic properties of construction materials

The particular properties of construction materials mean that choice of materials can affect both the acoustic quality of school premises themselves and their level of sound insulation.

→ Airborne sound reduction index R

The capacity of material to prevent airborne sound transmission is assessed by its sound reduction index known as R_w (dB). The sound reduction index is the difference between sound levels recorded on either side of a partition or material between the emitting and receiving rooms. The higher the sound reduction index R_w , of a material, the better is its capacity to reduce sound. Not all walls have the same sound reduction index R.

E.g³ :

- 7 cm thick plaster block: 35 dB
- 20 cm thick, hollow terracotta brick: 48 dB
- 20 cm thick concrete block with cement render: 52 dB

→ Absorption capacity

A material's acoustic absorption capacity shows its capacity to absorb sound vibration within its own structure. This capacity is defined in terms of a number ranging between 0 and 1. The higher it is, the greater the absorption capacity of material. The table below shows the absorption coefficient of various materials according to frequency:

Material	Frequency (Hz)					
	125	250	500	1000	2000	4000
50 mm mineral wool 100 kg/m ² density	0.27	0.62	0.82	0.93	0.81	0.76
20 mm wood-fibre panel 230 kg/m ² density	0.15	0.44	0.45	0.44	0.53	0.59
4 mm glazing	0.03	0.03	0.03	0.02	0.02	0.02

Source: *L'isolation phonique écologique - Matériaux et mise en œuvre*, J L Beaumier, Terre Vivante, Mens, (2006)

SUSTAINABLE REFURBISHMENT OF SCHOOL BUILDINGS

1. COMFORT AND QUALITY OF LIFE



→ Specific mass (density)

A construction material with higher specific mass and inertia provides greater insulation against airborne noise.

→ Thermal insulation and acoustic insulation

Given the similarity between the materials used, one might assume that thermal insulation also produces acoustic insulation. However, thermal insulation will also provide acoustic insulation only if its structure is openly porous (plant and mineral wools).

1.5.2.2. Principles of acoustic insulation

One refers to acoustic insulation when implementing measures designed to limit noise transmission through living or working areas by addressing both their envelope and structural elements.

→ Limiting direct transmission

The following principles are used to limit direct transmission through a classroom:

The principle of mass

According to the law of the mass, the heavier material is, the better its acoustic insulation properties. Mass is particularly effective for reduction of airborne noise.

The mass-spring-mass principle

This is the principal that is most used for acoustic insulation. It consists of producing a skin element using three layers of materials with different characteristics, in order to absorb or capture the maximum amount of different frequencies and wavelengths:

- 1st layer (mass): material with high inertia: reflecting a large part of the incident soundwave and absorbing the rest;
- 2nd layer (spring): absorbent material: dispersing a part of the soundwave within the material
- 3rd layer (mass): material with high inertia: reflecting part of the soundwave into the absorbent material

Use of an acoustic strategy that uses mass raises the issue of the structural capacities of the building. For refurbishment, in case of doubt, choice of a lightweight acoustic system can prove useful according to the type of noise pollution.

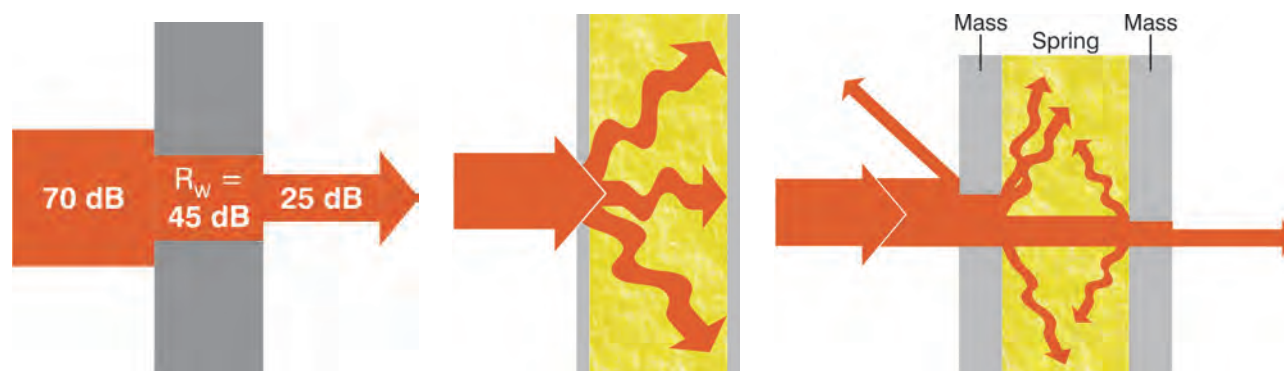

→ Limiting lateral transmission via structural elements

To limit lateral transmission via structural elements, the principle of separation is applied. The principle of separation of structural elements enables noise propagation by vibration through the existing structure to be prevented.

For refurbishment, this solution can only be applied to existing floors and new partitions installed as part of the project.

Resilient materials are those materials that will resist sound wave propagation between two structural elements, allowing separation between them. Materials such as cork, plant-fibre felts (cellulose-linen, hemp) or foam (rubber or synthetic).

→ Limiting parasitic transmission

The principle of sealing is applied to limit parasitic transmission. A hole, a large crack, a pipe run, poor sealing around a

frame can spoil all efforts to acoustically insulate the envelope. If air can pass, then so can sound.

Good acoustic insulation, therefore, assumes good airtightness and maximum homogeneity of the envelope.



Picture - © Easy-liege.fr



Picture - © Insulco.be



Picture - © Insulco.be



Picture - © Insulit.be

1.5.2.2. Principles of acoustic correction

Acoustic correction is referred to in relation to modifying the interior properties of premises so as to address reflection of sound waves from the interior skin of the premises where the noise is produced. Acoustic correction allows improvement to the quality of perceived sound (improving listening conditions), and to the acoustic environment of a room without, reducing its sound level. Acoustic correction will mainly address reverberation time. When carrying out acoustic correction, it is assumed that the emitter (the sound source) and the receptor (the ear) are in the same room.

→ Rules of acoustic correction

The condition of the surface and the composition of the envelope skin (walls, floor and ceiling) of an existing space to a large extent determine its acoustic characteristics. According to the intended use of a room, its acoustic characteristics can be improved by attention to the following principles:

Combining reflective and absorbent surfaces

According to the intended use of the area, envelope surfaces should alternate between smooth and reflective (plastered wall), and absorbent (perforated rigid lining with insulation).

In addition, some furnishings enable reduction of noise reverberation: absorbent materials (floor, ceiling and wall), wall coverings or hangings, fabric blinds, furniture etc.

The proportions of the room

According to the intended use of the room, certain proportions (length, width and height) will affect the acoustics.

The surfaces to be treated should be distributed around the room (10 x 1 m² rather than 1 x 10 m²).

→ Acoustic correction materials and components

Various materials or components can help improve a room's acoustics.

Absorbent materials

These fibrous or porous materials (large air pockets) will reduce sound wave propagation by preventing its reverberation on the walls. These materials absorb at both high and low frequencies.

Vibrating panels

These components enable absorption of incident sound wave energy by causing the panel to vibrate, rather than the envelope. They absorb low frequencies only.

Acoustic panels

These components absorb incident sound wave energy by vibrating the air within each air pocket (or hole) in the panels. They absorb all frequencies.

1.5.3. Improving acoustic comfort in classrooms

When undertaking school building refurbishment, it is essential to investigate and improve the building acoustics to control and/or limit noise from the external environment and from equipment (ventilation, heating etc.), to ensure adequate insulation from impact noise and, above all, to avoid the two most frequent defects: excessive reverberation of premises and poor insulation between rooms or between a room and circulation areas. In this way each teacher and each pupil will be offered an acoustic environment compatible with effective and high quality teaching and learning.



Sound absorbing panels - © Acoustissimo



Acoustic panels - © www.ardal.fr

The designer, if necessary, should make sure to:

- insulate the building envelope against external noise;
- insulate the premises from equipment noise;
- insulate premises from each other for both airborne and impact noise;
- improve or correct the acoustics of each room, if necessary.

1.5.3.1. Room by room assessment

The first step in treating an acoustic problem in an existing school building, is to diagnose the situation in order to understand what is experienced as noise disturbance, the source of the noise nuisance and how it propagates within the building. Such nuisance can be external and/or internal to the existing building.

Noise disturbance cannot always be immediately identified, especially for multi-storey buildings, and floor by floor analysis may prove necessary.

It is of paramount importance to determine the sound source, by differentiating between airborne noise, impact noise and noise from equipment, machines or building services (ventilation, air conditioning etc.).

Once the noise pollution source has been isolated, it can be measured using a sound meter. The results will be weighted applying a filter (A), in order to approximate to the sensitivity of the human ear.

If visual and aural observation do not suffice, more detailed investigation by a specialist should be considered.

1.5.3.2. Improving acoustic insulation of premises – External noise nuisance

In most old buildings, the facade walls are generally good acoustic screens, because of their high mass. However, airtightness defects can lead to propagation of noise within the building. The two weak points of the envelope of an existing building are the window frames and glazing and separately installed components, such as ventilation grilles, shutter boxes etc.

For window frames and glazing, the critical point is not generally the glazing, but the openings between casements (lack of flexible seals) and between casements and the fixed frame (poorly tightened). It is a priority to check these two components when seeking to improve the acoustics when refurbishing a school building located in a noisy or very built-up environment.

Improvement of acoustic insulation when there is external noise nuisance, it can be done in two ways:

→ Installation of acoustic screens between the building and the noise source

When the school building is close to a major external source of noise, the designer should investigate the possibility of installing acoustic screens (plant or constructed screens), which will absorb part of noise and thus reduce the intensity of sound perceived by the occupant.

Interior sound screen

Changing the internal layout of the school premises, by situating plant and facilities rooms as a screen between the external sound source and classrooms.

Exterior sound screen

Changing the layout of external spaces by planting trees, hedges or any other planting between the noise source and the building. To be really effective, these plants screens must be of a certain thickness. However, they have a real psychological impact on the occupants as they both hide the source of noise nuisance and improve the quality of outdoor areas.



→ Treatment of the envelope

Changes to the external envelope mainly involve improving the performance of doors and windows, improving the airtightness of the structure and facade claddings and improving the acoustic insulation of the roof.

For sustainable refurbishment, both thermal and acoustic comfort can be addressed by attention to the performance of the external envelope and careful workmanship to the various elements composing it.

Work to facades

Works to improve the acoustics of facades essentially concern joinery, air intakes (vents and grilles) and some applied elements (shutter boxes). Nonetheless, attention will also be paid to the condition of the external finish (render, timber cladding etc.) and to airtightness defects. Whatever improvements are made, especially with regard to insulation (thermal and acoustic) and to airtightness, these should not under any circumstances interfere with ventilation to the building and its various rooms.

Joinery

The goal is to simultaneously improve the acoustic insulation of the frame, by making it airtight (preventing all draughts) and sealing the joints between frame and wall. Four solutions can be considered:

- Conservation of frames and glazing, improving their airtightness (remaking seals to the frames, airtightness of joints between frame and wall etc.);
- Conservation of frames (fixed frames and casements) and installation of acoustic glazing;
- Installation of new, airtight joinery suitable for acoustic glazing;
- Installation of secondary double glazing, for listed buildings or very large windows.

Ventilation openings

Existing air intakes will be replaced by acoustic grilles or vents, enabling the passage of air, while considerably reducing propagation of external airborne noise.

Works to the roof

Installation of thermo-acoustic insulation below the roof will allow considerable attenuation of some airborne noise. However, if vibration of the roof is transmitted to the facade walls, more complex solutions of separation need to be investigated with a specialist.

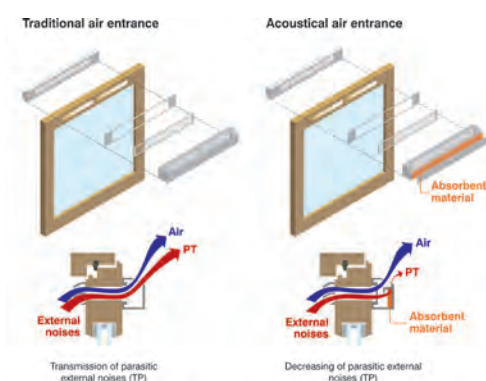

SUSTAINABLE REFURBISHMENT OF SCHOOL BUILDINGS

1. COMFORT AND QUALITY OF LIFE



1.5.3.3. Improving acoustic insulation of premises – Internal noise nuisance

Internal noise in an existing building is either airborne or impact noise. Improvement of acoustic insulation when there is internal noise nuisance, can be achieved in several complementary ways:

→ Change of internal layout

One way of limiting the impact of noise nuisance within a building, is to re-examine its internal layout, giving preference to spatial solutions based upon distancing and isolating noise sources. This involves:

- Rearranging and grouping sanitary facilities and building services reservations, so that ventilation ducts, soil pipes and water pipes are not in direct contact with classrooms;
- Avoiding situating plant rooms and noisy equipment in direct contact with classrooms;
- Using architectural components as acoustic screens (lockers, recreation areas etc.).

→ Treatment of separation elements

Treating and insulating elements that separate rooms also enables the limiting of noise nuisance propagation within school buildings.

Partitions between rooms

Works will essentially be concerned with the propagation of airborne noise. Works comprise:

- installation of acoustic lining: acoustically absorbent material + partition;
- installation of a resilient layer at the foot of and all around the wall.

Floors and ceilings between storeys

Works will be concerned with the propagation of both airborne and impact noise. Transmission of airborne noise between rooms is often facilitated by gaps left around pipework penetrations (heating etc.) between storeys and by rigid connections (collars or metal straps) between pipework and floors. Works to be carried out are as follows:

- Filling gaps using an acoustically absorbent material;
- Mechanical isolation of rigid joints;

When airborne noise is directly transmitted by the floor/ceiling, an acoustic lining is installed to the ceiling. Transmission of impact noise (e.g. footsteps or falling objects) can be reduced by installing a resilient layer between the structural slab and the floor covering. This uses a floating floor system.

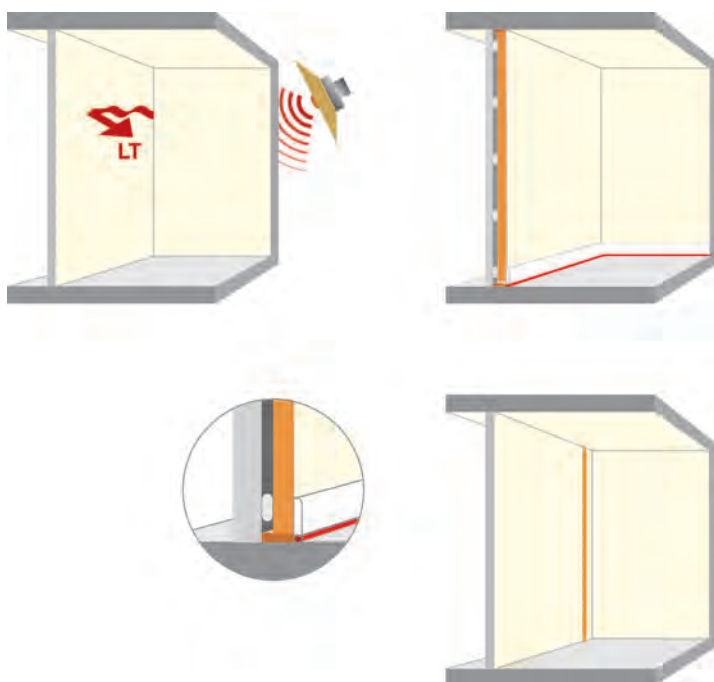

SUSTAINABLE REFURBISHMENT OF SCHOOL BUILDINGS

1. COMFORT AND QUALITY OF LIFE



Before

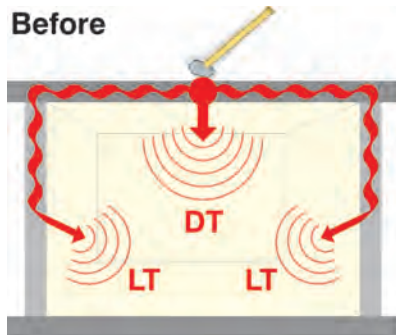

Dividing walls built with light masonry (radiating nature)

Solutions



Solution n°1
Covering replacing in the room where the noise is coming

All the rooms below are insulated (protected)

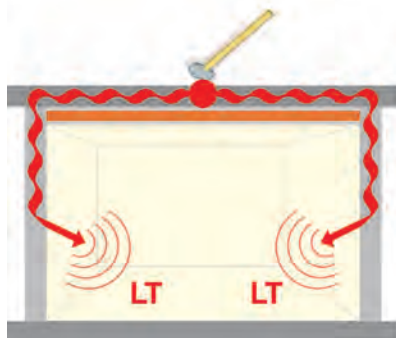

Solution n°2
Placing of an acoustical insulation on the ceiling

Partial treatment
Lateral transmissions are not resolved



Solution n°3
Placing of an acoustical insulation on the ceiling
Treatment of the walls

or

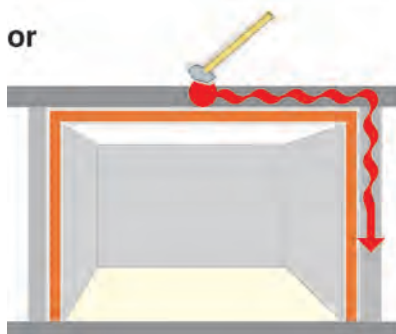

Complete solution

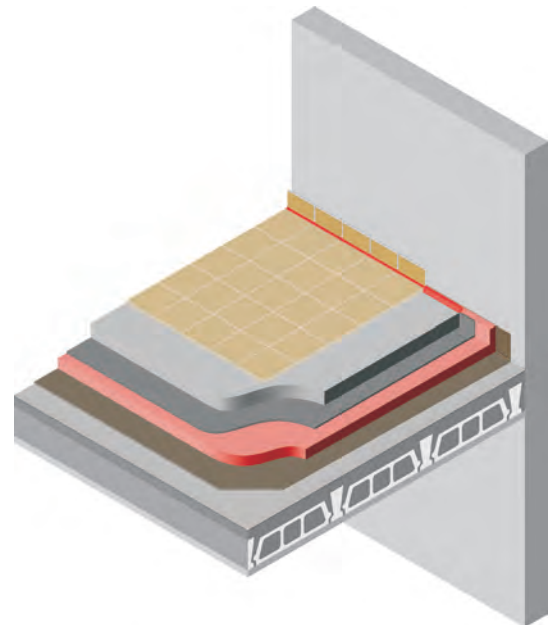

SUSTAINABLE REFURBISHMENT OF SCHOOL BUILDINGS

1. COMFORT AND QUALITY OF LIFE



1.5.3.4. *Improving acoustic insulation of premises – noise nuisance from equipment*

Noise nuisance caused by equipment can originate as airborne or structure-borne noise. To improve acoustic insulation, first of all, the noise source should be directly addressed to ensure it emits as little noise as possible. Next, the noise should be prevented from propagating within the installation or the structure, by installing anti-vibration pads and collars.

→ Plumbing and sanitary equipment

Pipework

- Limiting system pressure (3 bar max.) and limiting water flow speed in the pipework;
- Observing the minimum diameter for pipework feeding sanitary appliances;
- Mechanically isolating pipework from the building structure using collars and sleeves of resilient material.

Sanitary appliances

- Choosing quiet equipment that emits little vibration;
- Avoiding water hammer;
- Mechanically isolating sanitary appliances from the building structure.

→ Heating equipment

Heating

- Insulating the plant room from other premises and making it of adequate size;
- Mechanically isolating the boiler from the building structure.

Heating pipework installation

- Using anti-vibration sleeves between ducts and the appliance.
- Limiting the water flow speed in pipes (1 m/s).

Appliances and heating element

- Installing technical equipment that is quiet and emits little vibration;
- Mechanically isolating the appliances from the building structure using anti-vibration pads or fittings.

→ Ventilation equipment

Plant room

- Situate the plant room and fans at a distance from other rooms.

Appliances (fans)

- Selecting quiet fans with a low rotation speed;
- In order to reduce impact noise, ventilation ducts should be connected to the fan with flexible sleeves and the fan should be installed on a concrete slab resting on anti-vibration pads.

Ducts and conduits

- Providing conduits and ventilation outlets with noise damping;
- Limiting airflow speed and making conduits airtight;
- Avoiding right-angle elbows;
- Using acoustically protected air intakes, which allow the passage of air but limit the entry of sound by means of chicanes and sound-absorbent materials along their entire length.
- Mechanically isolating conduits from floors using anti-vibration fittings.
- Avoiding rigid and lightweight ducts. Giving preference to heavy materials or using several sheets of fibrous plasterboard with a compressible insulation material between them.

1.5.3.5. *Acoustic correction of a room*

Acoustic correction is treating the absorption and reflection capacity of one or more of the envelope surfaces of a room,

SUSTAINABLE REFURBISHMENT OF SCHOOL BUILDINGS

1. COMFORT AND QUALITY OF LIFE



addressing their texture, surface, proportions and finishing materials. Acoustic correction of a room comprises treating the various elements of its envelope in order to reduce or increase their reverberation time.

To recapitulate, the reverberation time of a room should, ideally be between 0.5 and 0.7 seconds. It is also recommended that the reverberation time should be no less than 0.4 seconds, as that also may be a source of discomfort (insufficiently reverberant environment).

Acoustic correction of a room often requires specialist intervention, above all when it concerns refurbishment of classrooms, auditoriums, theatres etc.

→ Modifying reflective and absorbent surfaces

The condition of the surface and the composition of the envelope skin (walls, floor and ceiling) of a constructed space to a large extent determine its acoustic characteristics. According to the intended use of the area, envelope surfaces should alternate between smooth and sound-reflective (e.g. plastered walls), and absorbent (e.g. perforated rigid lining with insulation).

To avoid a ping-pong effect between two reflective parallel walls, sound-absorbent material is applied to one of them.

→ Revising the proportions of the room, if possible

If this can be considered, when carrying out school building refurbishment, the proportions of classrooms should be examined.

Excessively regular proportions can have unpleasant consequences for the acoustics of a space. Consequently, it is important to make a careful choice of the relationships between the height, length and width of the room.



1.6. Ensuring good indoor air quality

Air quality is, first and foremost, determined by the level of ventilation achieved and by indoor pollution, including moisture production caused by user behaviour. Building materials with the lowest possible levels of pollutant emission should always be used.

1.6.1. Limiting pollution of indoor air

The quality of indoor air in school buildings can be improved, in a passive way, by addressing the following factors:

- Choice of construction materials, choice of construction method and finishing details and choice of furniture and teaching equipment;
- Interior layout of premises (giving preference to natural ventilation, ideally lateral);
- Upkeep and maintenance of the premises (cleaning products used etc.).

Obviously, air quality does not only depend upon the architect or designer. Each occupant must be made aware of this problem and the various forms of action to take to improve indoor air quality.

1.6.1.1. Indoor and outdoor pollutants

Air-quality, whether indoors or outdoors, is a factor that noticeably affects human health, particularly that of children. According to the World Health Organisation⁴, «... the lower the levels of air pollution in a city, the better respiratory (both long- and short-term), and cardiovascular health of the population will be.»

The European EnVIE⁵ project has demonstrated this, by surveying, by country, cases of illnesses that can be directly attributed to poor indoor air quality.

E.g. in the case of Belgium:

Each year, in Belgium, 12,000 cases of asthma as well as 10,000 cases of cardiovascular illness, 3000 cases of lung cancer and 12,000 cases of SBS (sick building syndrome) are due to poor indoor air quality. The study shows that over all the above-cited pathologies in Belgium, 7000 cases per year have their origin in the presence of excessive concentrations of VOCs.

→ Atmospheric pollutants

Various activities directly related to the construction sector contribute to air pollution:

- Production of thermal energy generates major emissions of combustion gases, dust and fine particles;
- Industry, which, besides combustion gases and dust, generates volatile organic compounds (VOCs), smell etc., according to the nature of its activity;
- Transport;
- Waste treatment.

The main atmospheric pollutants with a potential impact on health are sulphur dioxide (SO₂), carbon monoxide (CO), nitrogen oxides (.NOx), ozone (O₂), hydrocarbons (HC), heavy metals such as lead (Pb) and cadmium (Cd), and suspended particles, especially the finest ones (PM10 and PM2.5).

→ Atmospheric pollutants – European and WHO guide values

The WHO guidelines with regard to air quality are the most widely recognised and the most up-to-date on the subject of the effect of air pollution on health. These guidelines recommend air-quality goals that should enable substantial reduction of health risks.

A **limit value** is defined for each pollutant, representing the maximum concentration of that pollutant in the atmosphere, for the purpose of avoiding, preventing or reducing the harmful effects of these substances on human health and/or on the environment.

A **target value** is defined for each pollutant, representing a level of pollution set so as to avoid, prevent or reduce the harmful effects on human health and/or on the overall environment, which are to be achieved as far as possible in a given

⁴ Source: <http://www.who.int/mediacentre/factsheets/fs313/fr/index.html>

⁵ European EnVIE project (co-ordination action on indoor air quality and health effects - <http://www.envie-iaq.eu>) aims to produce a preliminary research report on the subject of indoor air quality in Europe, to highlight the proven effects on health and to prepare future development of EU policy.

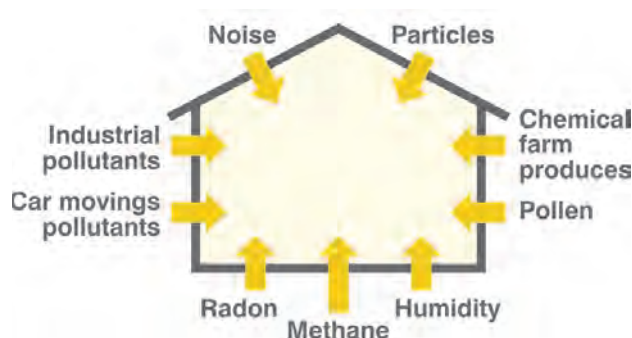

Pictures : Sylvie Rouche

period.

An **alert threshold** is defined as a pollution level above which short-term exposure presents a risk to human health, or a risk of environmental damage, and above which emergency measures must be taken.

An information threshold is defined as a level of atmospheric pollution which has limited and temporary effects on health in the event of short-term exposure and above which information should be issued to the public⁶.

→ Indoor air pollutants

Compliance with the new energy performance standards for buildings requires on one hand to strengthen the envelope insulation and on the other hand, to strengthen the airtightness. A strong envelope airtightness must be accompanied by an effective ventilation system otherwise the risk to deteriorate the indoor air quality could increase by a strong concentration of pollutants and the development of bacteria and fungi.

The question of indoor air quality is a major public health concern. Most Europeans spend 85% of their time in closed environments, where they are exposed to multiple pollutants, whether chemical or physical. These substances originate in the materials composing the building and, essentially, floor, wall and ceiling coverings, but also furniture, equipment and maintenance products.

The pollutants emitted by these various sources can adversely affect the quality of indoor air and, thus, have negative effects on well-being and health (allergies, eye and throat irritation, headaches etc.).

Besides this, these emissions can be increased by poor workmanship and by the type of environment or climate encountered: sunshine, temperature, humidity etc.

With regard to pollutants, a distinction must be made between chemical pollutants such as VOCs and physical pollutants such as fibres, dust, humidity etc., as well as radon gas, bio-contaminants such as mould, mites etc.

The principal chemical pollutants are benzene, carbon monoxide, formaldehyde, naphthalene, nitrogen dioxide, polycyclic aromatic hydrocarbons (especially benzopyrene), radon gas, trichloroethylene and tetrachloroethylene.

The WHO has published guide values with a view to protecting public health against these chemical substances, which are generally recognised as posing health risks and are often present inside buildings and rooms at levels of concentration harmful to health. These guide values are most often expressed in ppm (parts per million), mg or $\mu\text{g}/\text{m}^3$. They can be downloaded from the WHO website: http://www.who.int/phe/health_topics/outdoorair/outdoorair_aqg/fr/index.html.

→ Construction materials and emission of indoor pollutants

According to the doctors Déoux, construction materials can emit primary and secondary pollutants:

Primary pollutant emissions: these emissions are caused by the constituents of construction materials (second fix and finishing materials). These emissions are at a high level immediately after manufacture, diminishing by 60% to 70% during the first six months and generally disappear after a year.

Secondary emission of pollutants: these emissions are caused by the action on materials of humidity, high temperature, strong sunshine, various chemicals used for upkeep and maintenance etc.

This type of emission can increase over time and persist for long periods.

→ Humidity and indoor pollution

Humidity within a living or work area can also be considered a major pollutant.

SUSTAINABLE REFURBISHMENT OF SCHOOL BUILDINGS

1. COMFORT AND QUALITY OF LIFE

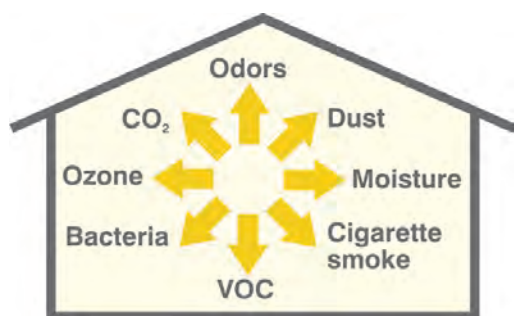

Pictures : XXXXX

Humidity encourages organic contamination and the development of micro-organisms, such as mould, bacteria, mites etc.

Construction materials, because of their particular constituents, can be the source of primary emissions. Relative indoor air humidity increases these emissions. However, humidity also causes chemical breakdown within construction materials, in particular when combined with the effect of alkalinity (e.g. finishes and adhesives in contact with concrete). These secondary emissions produced by the breakdown of the material can increase, last a very long time and have a major effect on the quality of indoor air.

1.6.1.2. Assessment of indoor pollution

Assessment of indoor air is, in practice, performed in two different ways:

- In situ, at handover of a site after completion of works, or when occupants experience nuisance;
- In the laboratory, when one seeks to assess the contribution of a particular material on the overall perception of air quality.

In the first case, measurements are taken of the concentrations of pollutants in the air within the building; while, in the second case, the material is placed under normal usage conditions in order to assess its contribution to the air quality of a model room, in terms of volatile organic pollutants.

Analyses of emissions from materials in a test chamber are regulated by European standard ISO 1600, Indoor air. All manufacturers, if they wish, can have the potential emissions of their materials analysed by approved centres.

1.6.1.3. Limiting indoor pollution by suitable choice of construction materials

Careful choice of construction materials – and essentially second fix and finishing materials, which are in direct contact with indoor air and the occupants – enables both limiting indoor pollutant emissions and regulation of the humidity level and indoor climate of various rooms.

→ Low emission materials

The choice of construction materials that do not contain or contain only a low quantity of pollutants is an overriding consideration for the quality of air and of school premises and space, since these choices enable indoor pollution to be minimised. The designer, when choosing materials, should take care to choose, for equal technical performance:

- Materials with limited emission of outdoor pollutants during the stages of extraction, manufacture, transport



Picture: Sylvie Rouche

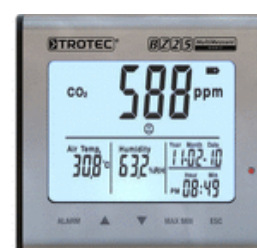



and end of life;

- Materials that do not contain particles and fibres;
- Materials that do not contain heavy metals;
- Materials that do not emit or emit only low quantities of VOCs⁷ ;
- Materials that do not emit or emit only low quantities of ozone and other gases;
- Materials that do not emit or emit only low quantities of radon gas and ionising radiation and materials that do not emit or emit only low quantities of non-ionising radiation.

The designer should also take care to choose insulation, second fix and/or interior finishing materials that are breathable (or humidifying), capable of absorbing or reinstating some air humidity without causing damage.

E.g. clay or lime-based render, wood or cellulose fibre insulation etc.

→ Choice of construction method and suitable implementation

Careful and suitable implementation allows sources of indoor pollution to be minimised, in particular:

- treatment of thermal bridges, selection and implementation of a vapor barrier coupled to the insulation layer eliminate or minimize the risk of condensation, mold or fungi;
- mechanical assemblies with screws and nails can prevent the use of glues and solvents that may be the origin of emission of pollutants.

→ Regulatory framework and indoor air quality certification schemes for construction materials

European regulations with regard to air quality essentially focus on outdoor air, imposing emissions limits on industrial pollutants, road traffic and power generation facilities. It is only during the past 10 years, that European regulations have mentioned the quality of indoor air. Regulations dealing with indoor air quality are: the REACH Directive 2006/121/EC, the General Product Safety Directive (GPSD) 2001/95/EC, the Construction Products Directive (CPD) 89/106/EC, and the Energy Performance of Buildings Directive (EPBD) 2002/91/EC. Since the 1990s, certification systems for construction materials, incorporating requirements in terms of indoor air quality have been developed in certain European countries:

- M1 classification⁸ (Finland);
- Indoor Air Climate certification⁹ (ICL), (Denmark);
- GUT¹⁰ /EMICODE/Blauer Engel¹¹ /AgBB (Germany);
- the AFSSET protocol (France).

These certification schemes are mainly based on limiting emissions and volatile compounds, and most of them were initiated and implemented by professional federations as a voluntary measure.

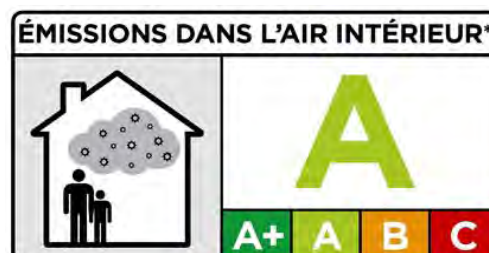

1.6.1.4. Occupants' responsibility with regard to indoor air quality

Indoor air quality also depends to a large extent on occupants' behaviour: lifestyle, presence of animals or plants, presence of smokers etc. While it is desirable that architects, by suitable and responsible choice of construction materials can improve air quality, they are not the only people with power to act.

⁷ VOCs labelling (France): Since April 2011, manufacturers of products intended for interior construction (except furnishing) have been ordered by decree to label products put on the market according to their potential for emission of VOCs. All products are classified from A+ (low emissivity) to C (high emissivity).

⁸ <http://www.rakennustieto.fi/index/english/emissionclassificationofbuildingmaterials.html>

⁹ <http://www.teknologisk.dk/lydelsler/253>

¹⁰ <http://www.gut-ev.org/fr>

¹¹ www.blauer-engel.de



It is essential to give responsibility to the school's users: teachers, pupils, management and maintenance personnel and to sensitise them to their responsibility for the generation or prevention of indoor sources of pollution. Various simple actions can considerably improve air quality in classrooms and school areas:

- Not smoking within the premises, including in staffrooms;
- Regularly opening windows to ventilate the classroom;
- Considering a responsible management of any small domestic animals in the classrooms, especially in infant schools (rabbits, hamsters, mice etc.);
- Considering a responsible choice of furniture and classroom decoration (coloured paint, fibre panels, plants etc.);
- Carefully choosing low-emissivity and low-toxicity cleaning products. Regularly cleaning classrooms to avoid dust accumulation;
- Carefully choosing handicraft products used in class (glue, varnish, paint etc.) and having a specific room for their storage.

1.6.2. Installing and/or optimising a ventilation system

To ensure good air quality, effective hygienic ventilation must be installed. This must enable a continuous supply of fresh air to the premises and extraction of pollutants present in the air, mainly humidity and CO₂, but also other pollutants described above. Hygienic ventilation has a significant energy cost. Relative thermal loss through ventilation of a building is even greater when the building is well-insulated and air ingress through the envelope is limited. If the building under consideration has an insulation level of K35, this thermal loss can reach 50% of energy requirements. Therefore, it is essential, when carrying out sustainable refurbishment, to optimise the hygienic ventilation system in a way that combines considerations of indoor air quality and energy efficiency.

1.6.2.1. Hygienic ventilation in schools

→ The importance of hygiene ventilation

The purpose of hygienic ventilation is to guarantee the quality of the indoor environment and occupant well-being and health, by adequate air replacement. In the context of energy-efficient refurbishment using high levels of insulation and good airtightness, there is little ingress of air and this is quite inadequate to guarantee sufficient air replacement.

With regard to classrooms, given the number of children per class, the indoor air rapidly becomes polluted with various substances (CO₂, VOCs, humidity, dust etc.). If these substances are present in large quantities, the occupants' environment becomes more and more unhealthy: breathing is less active, premature fatigue occurs, pupils' concentration diminishes etc. The risk of headaches and contamination increases etc.

It is thus essential, from the point of view of energy efficiency and that of comfort and quality of learning, to guarantee effective hygienic ventilation in classrooms and other school premises.

→ Why is just using windows for ventilation inadequate for schools?

Using windows for ventilation gives an intensive, periodic ventilation, which allows rapid elimination of pollutants emitted to the environment. It is inadequate for provision of basic, continuous ventilation, because:

- it relies upon the willing cooperation of the occupants;
- it is intermittent, while the emission of pollutants is permanent. This means that between the periods of the windows being open and the periods of them being shut, the level of CO₂, for example, will vary considerably within the room and often exceed the permitted limits. e.g. in a normally occupied classroom that is ventilated only between lessons, the limits are reached after just quarter of an hour's occupation;
- it can be a source of discomfort for the occupants, given the high level of inflow of cold, fresh air in winter or in spring and autumn;
- it is hard to regulate. The airflow is, thus, neither regular nor controlled.

1.6.2.2. The difference between air infiltration, hygienic ventilation and intensive ventilation

It is important to differentiate the concepts of hygienic ventilation, air infiltration and intensive (day and night) ventilation:

→ Air infiltration

Air infiltration is defined as fresh air entering the building through holes in the external envelope (large and small cracks, airtightness defects etc.). These airflows are not controllable (quantity, temperature, direction and duration) and vary

considerably according to outside weather conditions. One of the energy efficiency goals for refurbishment of school buildings will be, on the one hand, to increase the airtightness of the building (thus minimising heat loss) and, on the other hand, to limit fresh air supply to the quantity sufficient and necessary to maintain good indoor air quality.

→ Hygienic ventilation

Hygienic ventilation is air replacement necessary to provide the occupants with a healthy environment: without too much humidity, without mould and without dust or odour etc. Such ventilation is arranged so as to provide a particular air flow rate in each room of the building according to the activity taking place there. Thus, it is necessary to provide controllable devices for air intake and extract (adjustable openings of the correct dimensions and/or a mechanical ventilation system).

→ Intensive (day and night) ventilation

Intensive (day and night) ventilation is a passive method, which allows the building to be cooled without energy being consumed. The way the system operates and the air flows are noticeably different from those of hygienic ventilation.

1.6.2.3. Ventilation, current regulations and goals to be achieved

Every country has its own regulations for hygienic ventilation of non-residential and school buildings, in particular with regard to the rate of air intake and the ventilation system to be installed. Therefore, it is essential to refer to these regulations, with the knowledge that a child is not a little adult.

For sustainable refurbishment, the goal to be achieved with regard to the hygienic ventilation of classrooms is **to provide sufficient air replacement to maintain the level of CO₂ around 1000 ppm¹²**. European standard EN 15251 recommends an air change rate for classrooms of 7 l/s per person or 25.2 m³/h per person. With 25 pupils per class, this air change rate requires an airflow extremely important : around 640 m³/h

1.6.2.4. The various ventilation systems that can be considered when refurbishing school buildings

This chapter was written on the Energie Plus website: <http://www.energieplus-lesite.be>.

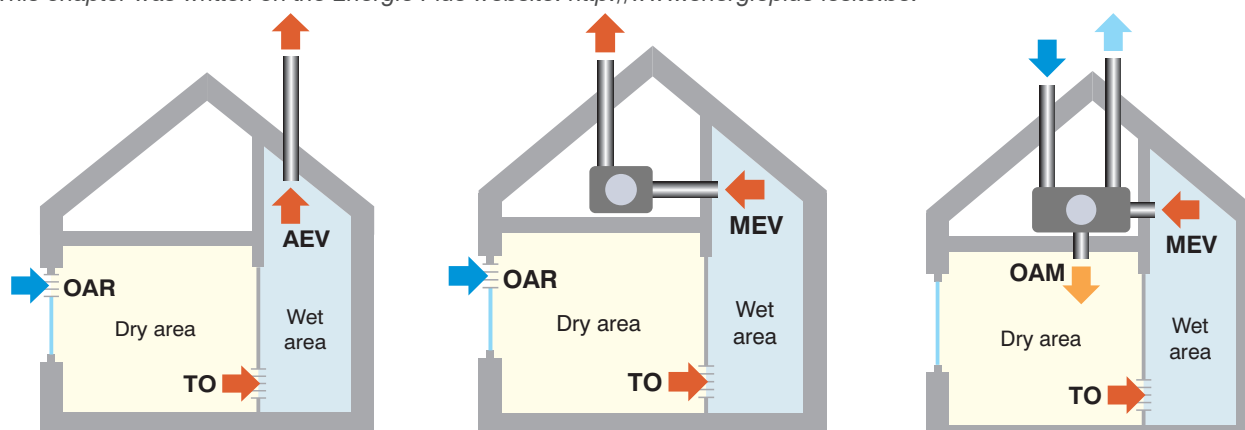

→ Ventilation systems

There are a number of hygienic ventilation systems

Natural ventilation

Air intake to the premises is generally via the facade using adjustable grilles (OAR). The air then passes through transfer openings (TO) set into the doors (undercutting or grilles) and is extracted in the sanitary facilities by adjustable extract vents (AEV) and conducted into vertical conduits, generally with outlets in the roof.

Ventilation with mechanical extraction (system C)

Air intake to the premises is generally via the facade using adjustable grilles (OAR). The air then passes through transfer openings (TO) set into the doors (undercutting or grilles) and is mechanically extracted in the sanitary facilities by extract vents (MEV) and vertical conduits, to the roof.

Mechanical ventilation (balance)

This is a completely mechanised system. The fresh air intake is generally located in the roof. Air is impelled into the premises via mechanical intake vents. The air then passes through transfer openings (TO) set into the doors (undercutting or grilles) and is mechanically extracted in the sanitary facilities by extract vents (MEV) and vertical conduits, venting to the roof. This system can be coupled with energy-saving equipment:

- a heat recovery exchanger, allowing heat to be exchanged between stale air and fresh air.
- an underground heat exchanger (or earth pipes) that allows incoming fresh air to be pre-warmed or pre-cooled.

→ General principles

Classrooms are generally supplied by circulation systems that also run through one or more sanitation facility but as for visual comfort (see point 4.3), several types of configuration can be highlighted:

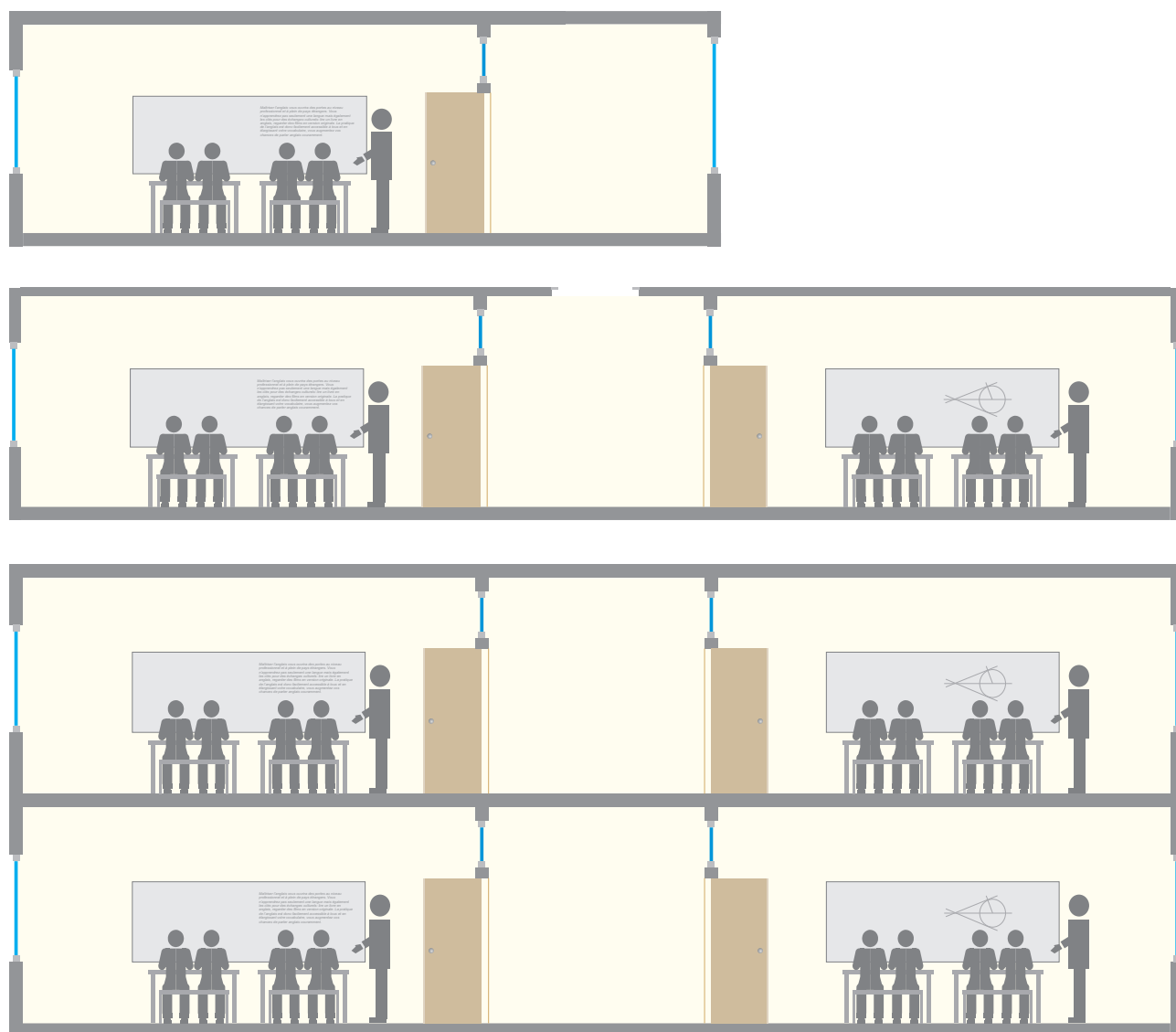

Ventilation with mechanical extraction (system C)

When outside conditions (limited amount of noise and pollution) permit, the simplest solution to employ for building refurbishment, is the ventilation with mechanical extraction.

Fresh air is, preferably, brought into the classrooms by means of automatically adjustable vents installed in the joinery or masonry of the facade. Stale air is extracted directly in the classroom, either via the circulation / corridor by means of an extract fan. Air transfer between classrooms and circulation is provided either by undercutting doors, or by suitable vents

SUSTAINABLE REFURBISHMENT OF SCHOOL BUILDINGS

1. COMFORT AND QUALITY OF LIFE



with louvre or other grilles.

However, this system does have disadvantages:

- It requires a large number of automatically adjustable air intake vents and often new windows frames;
- Noise transmission can occur via the transfer vents and the lack of incoming air filtration makes the system unsuitable for an urban environment;
- There is a risk of draughts caused by the intake of cool air into the classroom;
- There is a risk of the airflow being disrupted when doors and windows are opened.

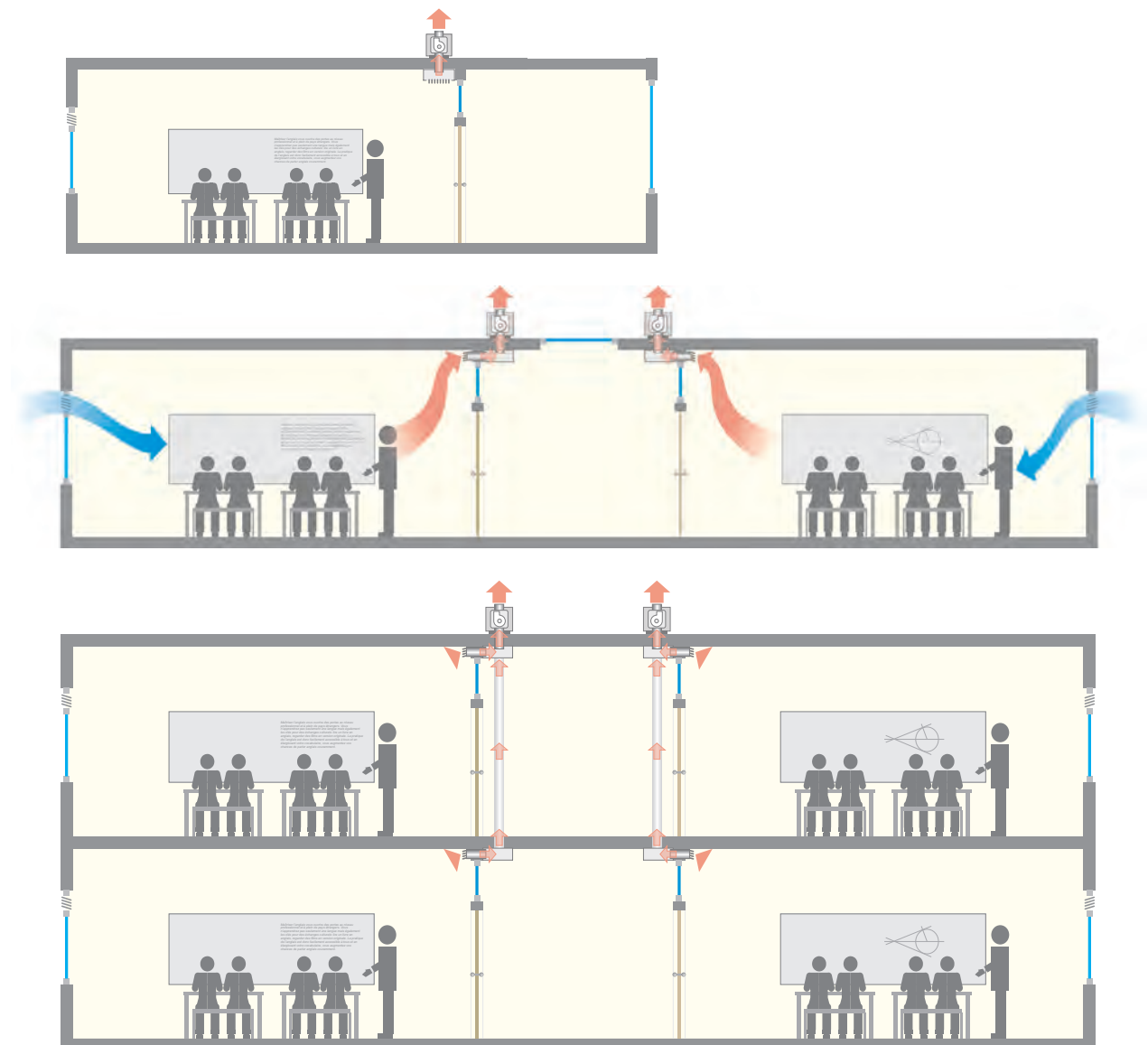

© www.renson.be



© www.renson.be

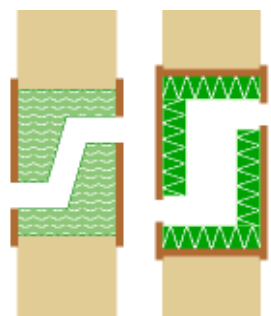

Design of acoustic transfer unit, if the air flow is made through the corridor

SUSTAINABLE REFURBISHMENT OF SCHOOL BUILDINGS

1. COMFORT AND QUALITY OF LIFE



Mechanical heat recovery ventilation with air impulsion and extraction (system D) - centralized or decentralized

The mechanical heat recovery ventilation system, i.e. a system equipped with mechanical impellers and extraction, is the best in terms of control of airflow in the premises: classrooms are assured a fresh air supply and extraction of stale air from the sanitary facilities occurs directly to the exterior. This system is practically essential in urban schools. Fresh air supply is provided by a system of ducts located in the false ceilings of circulation areas. Fresh air is diffused into each classroom through one or more inlets, either in the walls, if the duct comes down from the false ceilings in circulation areas, or in the ceilings if there is a false ceiling to the classroom. Extraction of stale air and its transfer are achieved in the same way as for the extract-only system.

The choice between mechanical heat recovery ventilation and extract-only ventilation will be informed by:

- the intention to assure proper distribution of airflow;
- the need for protection from the external environment (noise and pollution);
- the need to raise the temperature of intake air.

Mechanical heat recovery ventilation also enables:

- heat recovery by exchange of heat between extracted and fresh, incoming air;
- treatment of air temperature and humidity, if necessary, to ensure optimum comfort;
- partial recycling of air, in the case of ventilation air also providing room heating, cooling etc.

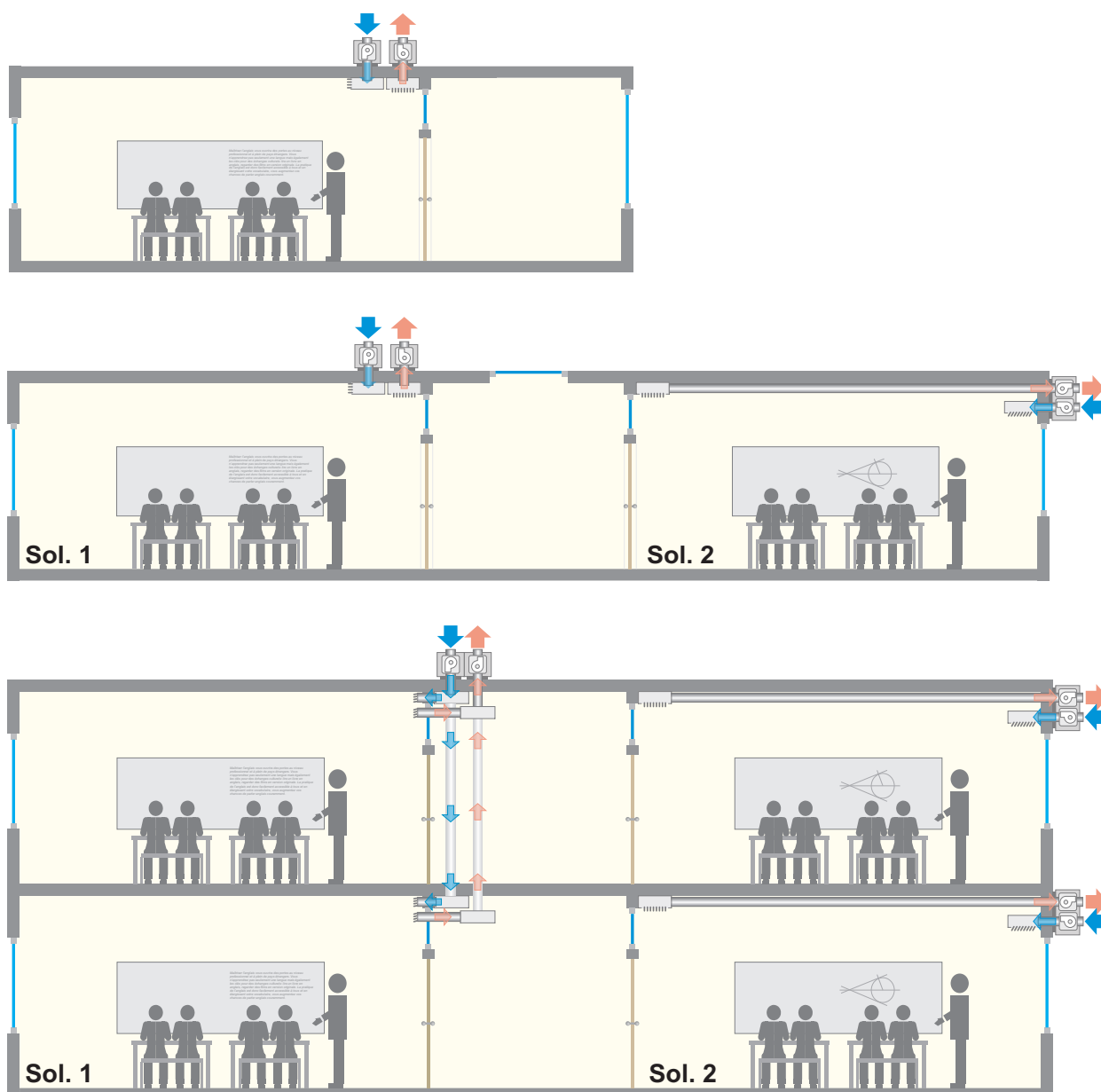



Balancing intake of fresh air and extraction of stale air

The number of classrooms in a school is often greater than the number of sanitary facilities. In addition, given the number of occupants per classroom, fresh air intake rates are very high and generally greater than the recommended level of air extraction from the sanitary facilities. As far as possible, the intake and extract airflows should be balanced, while allowing for the former to be slightly higher, to maintain slight pressurisation of the building and avoid parasitic air ingress.

However, extraction from sanitary facilities must not be over-designed, as this would risk draughts and discomfort in those facilities. One can then:

- set out additional extractor vents in circulation areas or auxiliary premises, e.g. storerooms etc.;
- provide classrooms with their own air extraction. This arrangement is necessary when the sanitary facilities are not directly accessible from the classroom area (sanitary facilities that are outside, in entrance halls etc.). In addition, it allows the avoidance of transfer grilles in doors, which can be a source of noise transmission between classrooms.

Construction considerations mean that it is not always possible, when refurbishing a building, to balance air intake and extraction. To facilitate installation in this event, it is possible to design an impelled fresh air intake in each room and hygienic extraction, according to the flow rates recommended by current regulations. This relies upon lack of airtightness of the building (doors being opened etc.) to remove the excess between air brought in and that extracted.

1.6.2.5. Criteria for selecting a ventilation system

Natural ventilation systems (non-mechanised air intake and extract) are generally the least expensive and easiest to install, so they are often preferred to mechanical systems (extract-only or mechanically assisted ventilation according to the criteria below:

→ Selection criteria for mechanical extraction

- Compliance with current regulations;
- Possibilities for installation;
- Reliability and effectiveness of extraction of indoor pollution;
- Assuring acoustic insulation in classrooms (non-admittance of noise nuisance);
- Compliance with fire regulations.

→ Criteria for selection of mechanical impulsion in a closed classroom

- Compliance with current regulations;
- Assuring supply of sufficient fresh air;
- Quality of indoor environment (pollution, noise etc.);
- Risk of draught;
- Installation and maintenance cost .

→ Ensuring a satisfactory outcome

The effectiveness of ventilation can be defined as its capacity to actually extract pollutants from the premises. To this end, it is essential to ensure that the replacement air is properly distributed within the classrooms and is extracted after being mixed with the ambient air. The ideal solution is, to mechanically impel the replacement fresh air and extract stale air directly in the room. However, this solution of independent ventilation to each room is expensive, because it requires a double air supply installation. The mechanical heat recovery ventilation system with impulsion of air in classrooms and extraction in the sanitary facilities at least assures a proper supply of fresh air in the classrooms and extraction of odour in the sanitary facilities.

Natural ventilation or extract-only systems do not always assure proper air replacement in all classrooms. Furthermore, airflows provided by natural or extract-only systems are dependent on weather conditions and, thus, hard to control.

→ Indoor environment

If the outdoor environment is particularly polluted and/or noisy, fresh air intake vents must include filters and acoustic insulation. Fresh air intake vents, even when fitted with sound proofing systems, still allow ingress of external noise and, above all, dust. In crowded urban areas, mechanical impellers, fitted with filters are necessary, the intake of outdoor air must also be located in a less exposed place.

→ Acoustic insulation between rooms

A particular activity in a room can generate noise nuisance to other classrooms. The presence of air transfer grilles makes acoustic insulation between rooms difficult. In this situation, two solutions can be considered:

- Use of acoustically baffled transfer grilles. As these are larger, it is easier to install them to walls than to doors. They also cause a greater loss of air flow rate than traditional grilles;
- Equipping rooms to be acoustically insulated with their own extraction system, thus eliminating air transfer.

→ Demand for preheated air supply

In winter, or mid-season, when there is a large temperature difference between indoors and outdoors, the fresh air flow rates required can cause some thermal discomfort. Ideally, to avoid the sensation of a cold draught, the fresh air supplied should be preheated to a prescribed minimum temperature. Preheating the air will only be possible with a mechanical impeller fitted with a heating element. In the case of mechanical impulsion, preheating fresh air also serves the purpose of preventing excessively cold air circulating in the ducts, which could cause condensation.

There are different ways of preheating incoming fresh air:

- with a hot water coil or electrical resistance heater;
- by heat recovery on the condenser of a cooling unit (where there is an existing air conditioning system);
- by passive heat recovery, via a buffer area of the building (atrium etc.) or by an underground heat exchanger (geothermal energy);
- through a heat exchanger, recovering energy from the air extract. This is a very good solution from the energy-saving point of view. It allows recovery of 50% to 85% of heat from extracted air (according to the type of heat exchanger selected).

→ Combining ventilation and heating

In the case of advanced energy renovation of school buildings, it seems hardly feasible to combine ventilation and space heating for the following reasons:

- Demands for heating and ventilation are not simultaneous: classrooms must be heated before students arrival (ideally before 8:00 am) but not ventilated. If there are no students in the classrooms (during lunchtime), classrooms the class must also be heated without being ventilated;
- Combination of the two systems complicates strongly the management and the control of the systems

→ Opportunities for installing ventilation systems during refurbishment

The ventilation systems proposed above differ according to their bulk and the changes they require to an existing building. Extract-only ventilation is the easiest to install but requires air inlet in frame or façade. According to the configuration of the building, it can be installed without much ducting. Mechanical heat recovery ventilation requires air supply to the entire premises. It requires an installation of vertical and horizontal ducts, generally installed in false ceilings.

→ Energy consumption and cost

When carrying out refurbishment, it is important, before installing or improving a ventilation system, to compare the desired performance, the financial investment to be approved and the system's running costs. Financial investment increases with the scale of mechanisation. The same applies to the running costs.

Conversely, mechanical heat recovery ventilation allows better control of ventilation flow rates and, thus, heat loss. Energy consumption can be reduced through use of a heat recovery exchanger.

A mechanical heat recovery ventilation system also enables automatic, room-by-room management of ventilation airflow by working directly at the impeller outlet vents, e.g. according to classroom occupancy level. This is not currently possible

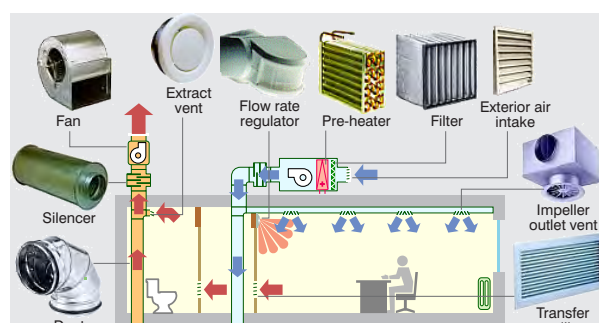
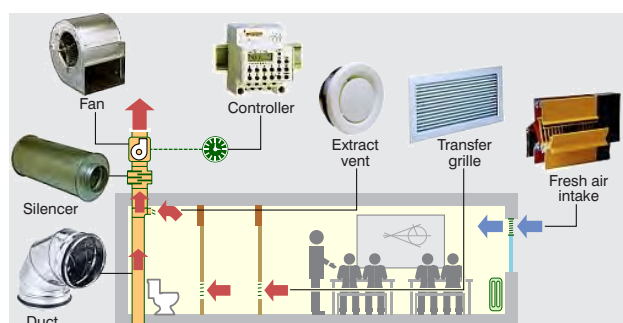

SUSTAINABLE REFURBISHMENT OF SCHOOL BUILDINGS

1. COMFORT AND QUALITY OF LIFE



for extract-only ventilation.

1.6.2.6. Ventilation and filtration

The primary objective of a ventilation system is to bring fresh air into a room or a building, in a manner that meets the occupants' need for respiratory comfort or an indoor air quality requirement. That objective means that the air filtration system is important. Filtering the ventilation system enables particle pollutants to be removed from the air.

Filtration of external pollutants: the outside air brought into the premises is filtered either by simply passing through a filter or by a recirculation system installed within the building.

Filtration of internal pollutants: this is performed by an indoor air recirculation system, passing through a filter which decreases the concentration of pollutants. The filters can be installed to the circuits for intake of fresh air from outside, to the circuits recovering air before recycling, to the circuits distributing air to the premises, or to the air recovery circuits upstream of the heat recovery unit.

→ Effectiveness and level of filtration

The effectiveness of a filter is specified in detail by a series of measurements depending upon the characteristics of inflowing air: temperature and humidity, dust content and/or grain size, type and structure of dust. Very coarse filters will cause dust to be propagated through the installation, harming the equipment and causing discomfort. Over-specified filters will, pointlessly, increase heat loss and, at the same time, increase fuel consumption by the fans to provide the same air flow rate. It is, thus, necessary to select a compromise solution when designing the filter installation, so as to ensure control of air quality with regard to particulates and bacteria, while avoiding energy-hungry over-design.

1.6.2.7. Ventilation and refurbishment

There are two possible pre-existing conditions for school building refurbishment

No system of ventilation installed (as with most Belgian schools)

Ventilation by opening windows is the only method used, even though it does not meet hygiene and comfort criteria:

- the containment of air for a normally occupied classroom that is ventilated by opening windows between lessons occurs after the room has been occupied for quarter of an hour. Moreover, the ventilation is completely subject to the willing cooperation of the occupants;
- opening windows causes large movements of cold air, which renders continuous ventilation while the room is occupied, i.e. during the time that pollutants are being produced, practically impossible.

There is a pre-existing ventilation system (as is the case in Norway, Denmark or Germany)

When refurbishing a school building that already has a ventilation system and when setting energy goals, the existing system should be checked for suitability to the new needs (layout, number of rooms etc.), as there is a risk of problems arising with condensation and mould (due to humidity), thus threatening the durability of the building and its air quality.

The existing installation might also be inefficient (noise, air flow rate etc.) and, if so, will need to be optimised to assure both thermal and acoustic comfort and air quality, while limiting energy consumption.

→ Installing a ventilation system

It is not an easy matter to integrate a ventilation system when refurbishing the building. Success very much depends upon the type of the building or buildings and classroom layout. Therefore, integration of the ventilation system must be taken into account from the project design stage with, as a precondition, proper airtightness of the building.

All the factors set out above will enable the designer and project owner to make a suitable choice. However, before choosing the type of ventilation to include, some preliminary steps are necessary:

- calculation of the minimum airflow to be provided in the various school premises;
- checking whether the available space for utilities is adequate to include a mechanical heat recovery ventilation system, in particular with regard to floor openings and the heights of false ceilings in particular parts of the premises (corridors, halls etc.);
- checking that there is sufficient available utility space to install the heat exchanger(s).

The ventilation system must also be planned according to other parameters:

- the efficiency of the envelope with regard to insulation and airtightness: if the envelope is very efficient, system D will be considered as this enables limiting heat loss through ventilation;

1. COMFORT AND QUALITY OF LIFE



- whether or not window frames are to be replaced: if they are replaced, system C can be considered with air intake in the window frames;
- combining heating and ventilation in well-insulated buildings, the heating input required will be considerably reduced. In this case, it can make sense to consider combining heating and ventilation within a mechanical heat recovery ventilation system.

→ Maintenance of the existing installation

These instructions apply to both existing and new installations. N.B. In some European or Scandinavian countries, it is mandatory to perform regular and periodic checks of ventilation installations. This is the case in Sweden, where ventilation installations in schools must be checked every two years.

The whole of the ventilation system must be regularly maintained, for the sake of both energy efficiency and respiratory comfort. Complete maintenance of an installation comprises:

Maintenance of fans

Fan components must be greased with appropriate lubricants at the intervals recommended by the manufacturer. This will ensure that components last longer and that the fans perform more efficiently.

For good operation, fans, especially ones that move polluted or dust-laden air, must be cleaned at regular intervals. The accumulation of dirt increases loss of static pressure, thus reducing the efficiency and power of the fan.

Maintenance of fans also includes regulating the noise level and vibration they produce.

Maintenance of filters

The complete set of filters in a ventilation system assures provision of air quality in the areas served. It is essential to ensure regular monitoring and maintenance of filters by checking power losses, which indicate that they are dirty.

When a filter is dirty, air flow rate is reduced and there is increasing loss of power; this shows itself through loss of filtration quality, a risk of failure to maintain differential pressures between zones etc.

Cleaning units and ducts

Over the years, dust and impurities are deposited in all parts of the installation. Under certain temperature and humidity conditions, dust and impurities allow the development of a large amount of microbiological flora. This can often become critical around heating and cooling units. This also causes a loss of output from the units, increased corrosion and danger of fire.

→ Optimising an existing ventilation system

After maintenance of the existing installation (cleaning fans and filters), it should be inspected in order to clearly identify weak points or defects. During refurbishment works, an existing ventilation system can be optimised, particularly with regard to the following points:

Improvement of the distribution system

Sealing the installation

Existing ventilation systems are generally thought to have very poor airtightness.

However, it is difficult when refurbishing to carry out sealing (adhesive tape, mastic sealants etc.) to the complete installation, even if it is exposed. All that is possible is to remedy the largest leaks. The ideal solution is complete replacement of rectangular distribution ducts by tubular ducts with double seals at joints.

Rebalancing the installation

Balancing and insulation means ensuring that each room has the necessary air flow rate, while ensuring occupant comfort and energy efficiency of the system.

Managing flow rates – partial renovation

Hourly ventilation management

The control of operating time is that the occupant (or school) can more easily manage itself. Interventions are simple and significant energy gains. A clock will control the ventilation system and flows depending on class times and occupancy.

In the choice of this method of management, some basic precautions should be taken:

- Adapt number of operation hours and operating timetable when the needs of local and assignments change;

1. COMFORT AND QUALITY OF LIFE



- Regularly check the clock programming;
- Modify the timetable according to the seasons: Ideally, when heating is not required in the classrooms, ventilation system should be stopped and the windows in the classrooms should be used.

Management of on-demand ventilation

Management of on-demand ventilation involves regulating ventilation flow rates according to the occupancy level of the premises. A sensor (occupancy sensor, CO₂ sensor etc.) controls either the air distribution outlets or the fan speed.

Siting of air quality sensor – CO₂ or VOCs sensor?

The CO₂ level is a useful parameter for the regulation of ventilation for premises occupied intermittently, because it indicates the number of occupants and indirectly indicates the pollutants and odour emitted by users.

Measurement of Volatile Organic Compounds (VOCs) is, above all, performed in premises that are very polluted by tobacco smoke or odour. This type of sensor is highly sensitive to odours of human origin, cigarette smoke, emissions from furnishing and decorating materials, cleaning products etc. For school building refurbishment, a CO₂ sensor is preferred, adjusted to approximately 1000 ppm.

This must be correctly located in the classroom, i.e.

- far enough away from the doors and windows to avoid being affected by outdoor air;
- far enough away from occupants (2 m minimum);
- in a position with proper air circulation (avoiding corners or angles).

Siting of a heat recovery exchanger – partial renovation

Ventilation fresh air, after being brought to the building's indoor comfort temperature, is then discharged to the outside with a higher energy level than the outside air being brought in. This is called enthalpy (heat content) greater than the outside air. The intention is to transfer that heat from the extracted air to the incoming air. A heat recovery exchanger on the air extract allows a gross recovery of 50% of energy consumption for fresh air treatment. So far as technically possible, adopting a heat recovery system for exhaust air is especially useful if there are:

- high air flow rates;
- permanent use of the ventilation system;
- an oversized fan and motor at the output.

Heat recovery for a ventilation system is explained in Section 2 «Services and energy efficiency»

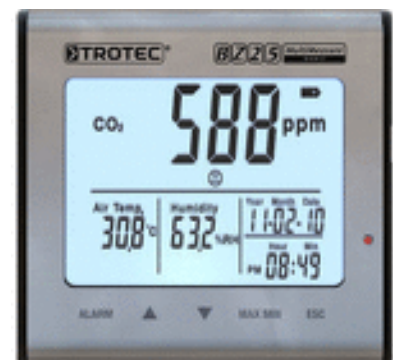



1.7. School, a place for teaching and learning

Children should always find school a joyful and enriching experience, both for learning and for their socialisation.

This can only happen if the educational project, but also the refurbishment project are centered around children, their pace of work, their personal and varied intelligence, their sensitivity, motivation and enjoyment of learning. Children also learn through the environments they inhabit. If these environments encourage children to have sensory, motor and relationship experiences, they provide major support for children's acquisition of autonomy and for their psycho-corporal development.

In its spatial approach and its management of space (articulating and laying out spaces etc.), school refurbishment allows pupils' learning to be improved or encouraged and supports teachers in their transfer of knowledge and civic values, as well as encouraging interaction and cooperation between the various players .

School buildings undergoing refurbishment and redesign must, therefore, be considered as educational spaces for children who are developing or being formed. To accomplish this, it would be useful to include a sociologist and a psychologist in the work team.

1.7.1. Space and pedagogy

Spatial setting out of schools, during a refurbishment project, involves harmonising these spaces with the school's educational project, with educational practice and learning goals. Nowadays, there are many different types of pedagogy or educational methods. Some examples are the pedagogies of Montessori, Steiner and Freinet; pedagogy that is explicit, documentary or based on problem-solving. Each of these pedagogies has particular needs in terms of space and its use.

Pupils today move about much more within the classroom and between the various school premises, much more than was the case 30 or 50 years ago, which was when most schools were built.

A school's internal layout needs to offer many opportunities for experience, whether sensory or motor, while also providing surroundings that are reassuring, safe and protective. It is, thus, fundamental that this layout should be warm, structured and diverse, while also being focused upon the children and their specific characteristics.

1.7.1.1. Children, a specific type of user

Children are a specific type of user. Smaller than adults, their metabolism is not yet mature. School-age children are busy growing, but also learning the rules of life and fundamental knowledge. They have an enormous need for space in order to move about, play, create and invent.

According to Dr S Déoux:

- between the ages of 3 to 6 years, children are creatures of drive and sensitivity. They learn through their bodies and through sensory experience. It is the variety and richness of lived experiences that leads them to think about a situation, to reason, to make decisions or formulate choices.
- towards the age of seven, children initially withdraw into themselves. They try to understand their new discoveries on the basis of their old experiences, to assimilate and organise them. This important reflective thinking allows acquisition of more mature judgement and a critical sense, to be open to an adult's reasoning and to overcome highly emotional situations. Little by little, children pass from reflection to expansion. Thirsty for knowledge and logical explanations, children seek to improve their knowledge.



Reading and relaxing area - Picture : Catherine Massart



Primary classroom - Picture : Sylvie Rouche



1.7.1.2. Infant classes

The infant school lays the pedagogical and educational foundations upon which future learning can rely and develop. These foundations are acquired and absorbed through play, which is children's spontaneous activity. Through play, children will exercise, develop their motor skills, relational and intellectual abilities. They will learn to name sensations and emotions, assimilate know-how and life skills and acquire a taste for discovery and experiment.

To achieve this, they need varied spaces that allow alternation between moments of calm, relaxation, listening, instruction-based activities, free play and emotional release. The layout of infant school classes, needs to meet these various needs while taking into account the teachers' needs: supervision, attention, ease of expression etc.

1.7.1.3. Primary school classes

Primary or elementary school places children between instruction that they receive and learning that they build. The teacher will put the children into situations in which they can become completely absorbed and where all their abilities (motor, emotional and intellectual) are called upon.

During this period, the teacher, but also the classroom premises, must ensure that learning occurs by stimulating the curiosity and creativity of each child, while respecting their autonomy.

1.7.2. A school accessible to all

Accessibility means enabling each person to access the interior of a building from public space consistently and continuously, while making all necessary arrangements with regard to autonomy, comfort and safety.

It is an essential condition for the integration of children and adults in the social (and economic) life of the school, since it allows all the school's players to enjoy and benefit from all the areas and equipment provided for work, learning, relaxation and/or meeting.

Accessibility concerns all the regular users of the school building, but also occasional visitors during school celebrations, parents meetings and extracurricular activities. It must be assumed that, among them, a certain number will have a difficulty due to a temporary or permanent handicap or caused by particular circumstances.

When carrying out refurbishment, the goal is to adapt all the internal and external areas of the school building to movement between and use of areas by people in wheelchairs. This includes parking areas, internal circulation areas, playgrounds, entrance hall, sanitary facilities, classrooms etc.

Each European country has legislated with regard to accessibility. Each designer will, therefore, refer to legislation in force and, accordingly, adapt the school building(s) to be refurbished.

1.7.2.1. Accessibility – major principles

→ Dimensioning

The lateral dimension of a person with neither a temporary nor permanent handicap is between 60 cm and 80 cm.

The lateral dimension of a person walking on crutches is 90 cm. The lateral dimension of a person in a manual or electric wheelchair is between 86 cm and 88 cm (turning diameter from 150 cm to 180 cm).

→ Parking areas

Ideally, 5% of parking spaces should be wheelchair accessible. A 80 cm wide, level access strip should be provided to the whole length of the parking space. A width of 3.75 m is recommended.

→ Horizontal circulation areas (exterior and interior)

The circulation area should, preferably, be level and/or single-storey both indoors and outdoors. It should be at least 150 cm wide for a principal circulation area and 120 cm wide for a secondary one. The width of the path or corridor must enable a person in a wheelchair to pass another, who should be able to hold a child by the hand or push a child in a pushchair.

A turning diameter of 150 cm must be provided in front of each door or passage and at each corner of the route.

The ground or floor surface should not present any obstacle to feet or wheels. The ground floor covering must not be loose or slippery and should have a flat, even surface. Exterior ground coverings such as earth, dolomite and gravel, as well as smooth materials and interior floor coverings such as carpet should be avoided.

The circulation area should be properly illuminated. Artificial illumination, when necessary, should be diffuse and indirect,

SUSTAINABLE REFURBISHMENT OF SCHOOL BUILDINGS

1. COMFORT AND QUALITY OF LIFE



avoiding effects of contrast and glare. It should be located in a zone above or below eye level, the length of the circulation area and above any access or door.

The circulation area should be signed using the international accessibility sign in white on a blue ground (drawing) and should be placed where it is easily visible at the beginning of the route, close to the entrance or garage door as well as on equipment for persons with reduced mobility. Any other sign should be legible at eye level for a standing person or a person in a wheelchair, between 1 m and 1.60 m. The route must not be obstructed by equipment: letterboxes, dustbins, drinks dispensers, plants etc.

→ Levels differences or slopes

The route may include levels differences. To assure its continuity, the appropriate solution is a ramp. The angle of slope must be comfortable (max. 5%) and is usually subject to regulations. Safety must be ensured by handrails and the edges must be sloped on either side.

→ Doors

Access to all doors must, if possible, be level. The width of a doorway is an important factor as well as the dimensions of the areas in front of and behind the door. A unobstructed space of 90 cm or more is generally recommended. A turning diameter of 150 cm must be provided in front of each door or passage and at each corner of the route.

The height of the door handle, push bar or pad, intercom or switch, as well as their distance in relation to a wall other than that on which such equipment is installed, must be properly assessed.

Attention must also be paid to the weight of doors, their opening direction and the presence of thresholds in the case of external doors.

→ Sanitary facilities

The layout of sanitary facilities must allow for a turning area of 1.50 m outside the space allowed for the door and the sanitary equipment. In general, the following dimensions are recommended: 150 cm x 200 cm or 220 cm x 220 cm (high comfort). WCs should be of the suspended type and fitted with one or two foldaway grab handles, according to their position. The access door should open to the outside.

→ Layout of other school premises

All school premises must be set out so as to facilitate access. This particularly concerns the canteen and the library, where counters must be of a suitable height. Seats and/or benches should be positioned so that there is a free space of 1.30 m x 80 cm available for a person in a wheelchair.

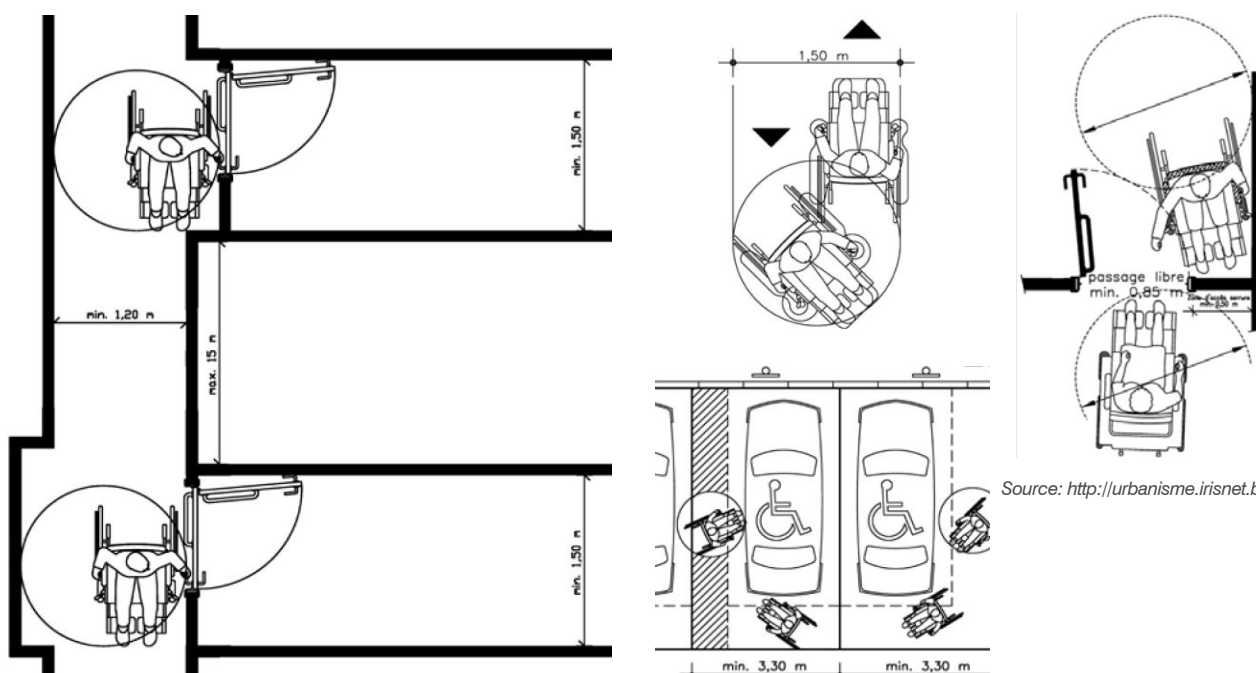



1.7.3. School refurbishment, meeting current and future needs

A key factor in functional quality and the evolutive nature of a school building is its long and short term adaptability:

- **In the short term:** the building, its rooms and their layout must meet current pedagogical needs. Learning consists of a succession of different activities: children sitting in silence at their desks, working in groups, manipulating materials and frequent movement between places. According to the activity, the number of children can also vary (especially transitional classes). The system and layout of the classroom must not, therefore, be set in stone but, on the contrary, offer various possible layouts. The arrangement of an area dedicated to a particular type of learning must also give meaning to that learning and support it. The area or dimensions of the classroom must provide a space for learning to take place by children working alone, in groups, as well as with a large number of pupils.
- **In the long term:** the population of a school, as well as that of a district, can change considerably over a period of 10, 15 or 20 years. The service life of school buildings and their components is greater than that time span. It is, thus, important that school buildings can be adapted to the various changes and needs of the school and its district with the least possible expense, use of resources and production of waste.

1.7.3.1. Flexibility, neutrality, evolution

Every building constructed or refurbished today is required to undergo changes in its use, whether with regard to its interior layout or its purpose. The ways in which we live, occupy buildings, work and learn change quickly and over timescales that are shorter than the service life of a building. The adaptability of the building means its capacity to undergo change, without affecting either its use or the services it provides. It must be possible to carry out these changes sustainably and at minimal environmental and financial cost.

→ Flexibility

The flexibility of the building is measured in terms of the ease with which its internal space can be restructured. It assumes an adaptable plan, demountable, possibly reusable, interior structures and easily accessible building services. These restructuring works must be able to be carried out while the building is occupied and with minimal nuisance and waste production.

→ Elasticity

Elasticity is the capacity of a building to be extended. The simplest and most common solution is an extension on part of the plot reserved for that purpose. However, other types of extension can be envisaged:

- Horizontal: extension of the storeys beyond the originally constructed facades;
- Vertical: additional of storeys, use of basements or underpinning;

Elasticity assumes particular thought being given to the site plan, volumetrics and interior layout, but also to the construction and structural system of the building and its facades.

→ Evolutivity

Evolutivity means the capacity of a building to integrate change or innovation both with regard to technical performance (heating, ventilation and illuminance) and with regard to lifestyle or the design of work or service spaces. It assumes a certain neutrality of the building (structure, envelope, interior layout) in relation to building services.

→ Neutrality

Neutrality is the capacity of the building to accommodate a major change of use. This supposes particular attention to the building's spatial layout, structural and services cores.

These concepts must be taken into account during refurbishment or change to the internal layout of school premises. The following guiding principles should be observed:

- preference for dry or demountable techniques;
- preference for frame or modular structures;
- preference for mechanical fixings that permit easier demounting;
- preference for exposed services;
- if possible (ideal situation) over design or duplicate some building services.



1.7.3.2. Functional quality of school premises

The functional quality of premises is defined as their capacity to be used properly and to meet needs. This functional quality is located on the one hand in the interior design (volumetrics, surface finishes and furniture) and the comfort afforded to occupants (visual, acoustic and thermal), and on the other hand in its ease-of-use, upkeep and maintenance.

→ Infant school classrooms

An infant school classroom must be able to offer differentiated areas dedicated to particular activities (games, manual activities, painting, meeting and assembly places etc.). It is hardly ever set out in a linear fashion, facing a blackboard.

These spaces must be easily adaptable, as each teacher may have an individual approach to organising their classroom space. A square or slightly rectangular plan is often preferable to a long plan. An L-shape can also be good so long as the whole surface area can at all times be supervised by a single person.

- usable floor area: on average between 70 m² and 105 m²;
- capacity: on average between 20 and 30 children.

→ Elementary school classrooms

An elementary school classroom must be able to offer a learning-friendly space while being easily adaptable. Location of the blackboard or white board and its lighting require special attention because each student must be able to read correctly and easily what is written: well positioned relative to all banks, no reflections or glare...

A square or slightly rectangular plan is often preferable to a long plan.

- usable floor area: on average between 60 m² and 90 m²;
- capacity: on average between 20 and 30 children.

→ Workshops, studios or laboratories

Workshops or studios are used for work that cannot be performed in the usual classroom (experiments, painting, language work etc.). The workshop or studio brings flexibility to the classroom space, allowing teachers to organise work in small groups, while being able to easily supervise each pupil.

To facilitate this supervision, it is useful to provide (discontinuous) glazed areas which can be obscured when necessary. For greater operational flexibility, having the studio or workshop directly accessible from circulation areas can be considered; direct access from the playground can also be useful.

- usable floor area: on average between 30 m² and 45 m²;
- capacity: on average between 10 and 15 children.

→ Equipment storage space

The shared equipment storage space generally serves as a reserve of small equipment. This space can also be used for bulky objects created during handicraft activities. This space must be close to classrooms and studios or workshops. It can be located within the studio or workshop area.

It must be a simple shape that facilitates storage. The entrance must be suitable for the passage of bulky objects or furniture. This space must be safe and secured from children.

→ Cloakroom

Cloakrooms must be passed through between outdoors and the interior of the classroom. Children will leave their outdoor clothes and, possibly, their footwear there before coming into the classroom. During inclement weather and in winter, the cloakroom must provide rapid drying of clothes and footwear.

Cloakrooms must be designed as an alcove separated from circulation areas. In this way, children changing will not get in the way of other people. Cloakrooms are also a buffer zone between circulation areas and classrooms or between outdoors and classrooms.

- usable space per child: 50 cm wide, on average;
- one coat hook per child; The battens must be securely fixed and suitable for the hanging of coats;
- there should be fixed benches below the coat hooks with space for each child. The pupils should all be able to sit down at the same time;
- there may be lockers;
- there may be shoe racks (for high and low boots in winter) and hat racks above the coat hooks (for hats, scarves and gloves).



Sanitary facilities - Pictures: Catherine Massart, Sylvie Rouche



Infant class, dining area - Picture: Sylvie Rouche

→ Sanitary facilities

The sanitary facilities must be centrally situated in relation to the classroom area (infant or elementary schools). They must be easily accessible from the playground and direct access from the cloakrooms is also desirable. This space must retain the maximum amount of privacy to the WCs and encourage the learning of hygiene.

→ Sleep room (in connection with infants classes)

The sleep room is there for children who need to rest, especially after lunch. It is usually the youngest children go to this room every day. It is desirable that sleep rooms are located close to infant school classrooms, so that children who make up can rejoin their class, but also to facilitate supervision by a teacher.

It is also important that the sleep room has direct access to or is close to the sanitary facilities.

- usable floor area: between 60 m² and 90 m² on average;
- capacity: 30 children;
- a simply-shaped area enabling beds to be set out.
- this room should provide a quiet and restful environment.

→ Circulation areas

Circulation areas provide for spatial distribution and connection between classrooms and other school areas. It is important that circulation areas offer general and diverse spaces and that they also enable access by persons with reduced mobility.

- usable floor area: 10% to 15% of total surface area of the other premises.

1.7.3.3. Flexible and adaptable spaces between several classrooms

Certain areas, such as studios and workshops, cloakrooms or sanitary facilities may be shared between two or more classrooms.

E.g.

- the arrangement of a studio or workshop shared by two classrooms, with a direct link (glazed surface) enables easier use. Thus, a teacher can, without leaving their classroom, supervise both the group staying in the classroom and the group working in the studio or workshop;
- cloakrooms or sanitary facilities may be shared between several classrooms;
- the use of stackable beds in the sleep room enables this space to occasionally be used for other activities that require a low level of lighting (film projection etc.);
- enlarging circulation areas enables them to be used for exhibition of work.

The studio or workshop can also be designed as an adaptable space, with sliding partitions, which will enable the classroom to be enlarged if appropriate.

It is also useful to provide a fairly large, neutral and flexible area that can be used for various school activities: play-space, in the event of very bad weather, space for organisation of events that are part of school life (suppers, film sessions, concerts, plays, exhibitions of work etc.).

This area can, under certain conditions, be used by local people, thus creating a direct link between the school and the neighbourhood.



1.7.3.4. Ease-of-use of efficient buildings: simplifying building services and their control

Building refurbishment aims to optimise both the building and the various building services or systems it comprises (heating, ventilation, climatisation, lighting etc.). If effective operation depends upon a well-designed services installation, its daily operation must also be conducted in the optimal way. This requires:

→ Control

It is important that the control and regulation of the installation is done correctly and consistently for the whole period of its operation. In many cases, the regulation of modern installations does not function well (or no longer functions well), with a serious adverse effect on energy performance.

→ The person responsible for building services

In many European schools, and especially elementary schools, the person responsible for building services is the headteacher. Headteachers do not generally have adequate technical knowledge to understand building services operation and management. They also do not have the time to spend on this problem, given their workload. Furthermore, most methods of building services operation and regulation are only accessible to technical personnel. This means that in many cases, building services are not operated optimally.

To improve this situation, which is at odds with energy efficiency and comfort, the following measures should be applied:

- installation of building services and control systems that are simple to use and energy efficient;
- raising the awareness of management, but also some volunteer teachers, about the various building services installed, their optimum operation and daily management;
- designing relatively simple and didactic user guides.

1.7.4. Learning and new digital technology: what are the impacts?

The use of digital technology is now obvious in all sectors of economic life, including schools. According to the European study «Survey of schools: ICT in Education»:

- There are now between three and seven students per computer on average in the EU; laptops, tablets and netbooks are becoming pervasive, but only in some countries.
- Interactive whiteboards are present in schools (over 100 students per interactive whiteboard), as well as data projectors.»

While many of today's schoolchildren were born in the 21st century and cannot even imagine a world without digital technology, a large proportion of the teaching staff was trained at a time when information was still scarce.

Today, they need to guide young people to grow and develop in a world where information has become superabundant. Schools have to meet this pedagogical, but also energy-related challenge, while being aware of electromagnetic pollution and other health impacts, which these new technologies may have on the health of children and teachers.

1.7.4.1. E-learning, growth of information technology in the school and energy management

The IT sector is evolving fast. Computers are becoming more and more powerful. Their numbers are growing, including in schools and in children's lives. Because they are an essential part of the work environment and because each of them uses relatively little power, computers, faxes or other printers are rarely thought of as energy-consuming.

However, the expansion of computing has reached such a scale that its energy consumption is becoming a major challenge, particularly for the services sector. Currently, the energy load of office equipment in the services sector is equivalent to that of lighting, i.e. 15% to 30% of total electricity consumption. This source of energy consumption is growing very fast.

The use of information technology is also growing in schools. It is, therefore, important to take this issue into account in the schools' energy management.

→ What is the energy consumption of a computer and printer?

The input power of a computer (PC) depends not only upon the PC itself, but also upon the peripherals it has to manage, e.g. modem, sound card, network controller, CD-ROM etc. This input power is entirely transformed into heat and distributed in the work environment. A basic configuration PC, with its screen, will absorb an average power of between 80 W and 160 W. This power is relatively constant during the period the device is in use and is very little affected by the number of times the hard drive is accessed.

The input power depends upon the type of processor and the type of screen. The first table on the next page, shows the ratings for various types of computer according to their operational status (active, sleep, off):

SUSTAINABLE REFURBISHMENT OF SCHOOL BUILDINGS

1. COMFORT AND QUALITY OF LIFE



Type of computer	Average energy consumption (W) - source: Energy Star		
	Active mode	Stand-by mode	Off-mode
Notebook PC	15	4	4
Budget notebook PC	25	11	7
Large format notebook PC	35	15	7
Small server	60	15	2
Budget PC	100	20	10
Multimedia PC	120	20	10
Workstation	200	40	15

Source: <http://www.energieplus-lesite.be>

The table below shows the ratings for various types of screen according to their operational status (active, sleep, off):

Type of screen	Average energy consumption (W) - source: Energy Star		
	Active mode	Stand-by mode	Off-mode
15" budget LCD*	15	5	5
17" top of the range LCD	25	5	5
17" budget LCD	30	5	5
17" LCD	35	5	5
15" LCD	40	10	5
17" large format CRT**	60	3	3
21" budget CRT	115	5	3

* LCD: liquid crystal display
** CRT: cathode ray tube

Source: <http://www.energieplus-lesite.be>

→ What are the thermal loads?

One may consider that all the energy consumed by computer equipment is dispersed in the indoor environment in the form of heat. These internal loads can, in some premises or some classrooms, rapidly become significant and require corrective measures.

Above a certain limit, a climatisation system becomes necessary to assure occupant comfort. This too is a major energy consumer. However, putting equipment in sleep mode can considerably reduce its energy consumption and, at the same time, the heat it produces.

It is, therefore, essential for schools that teachers and pupils take responsibility for the rational and energy-efficient use of computers. Written instructions on each computer can help to create awareness among children and teachers.

→ What behaviours should be adopted with regard to energy management?

User behaviour has an enormous effect on energy consumption. During lessons, children are in front of the computer



from time to time, rather than constantly. Their operational status should, thus, be properly managed.

Modern computers have three distinct modes:

- Active mode: the computer always operates in active mode.
- Sleep mode: from the time that this is activated, the computer will automatically put itself into standby mode after 30 minutes (principally stopping the hard drive and screen).
- Energy-saving mode: if this is activated, then if the equipment is not used, it will pass into standby mode within 10 to 15 minutes. Active mode energy consumption can be reduced by 25%.

Children should also be made aware that they should switch off the computer when it is no longer needed or before going out to the playground, or for a break. Written instructions on each computer can help to create awareness among children and teachers.

1.7.4.2. Electrical equipment, mobile phones and Wi-Fi – what is the impact on children's health?

Working on computers can cause thermal discomfort, due to the heat produced, and can affect air quality, particularly due to the use of certain flame retardant substances in electronic circuitry.

In 2005, the Japan Electronics and Information Technology industries Association (JEITA) produced guide values for VOCs for computers bearing the PC GREEN LABEL. This label certifies that a computer meets environmental criteria with regard to its design, manufacture, recycling and reuse of equipment. Source: DEOUX, Bâtir pour la santé de nos enfants

Computer use, but also the widespread use of mobile phones and high-output Wi-Fi wireless connections raise fears about various types of electromagnetic radiation.

This question is the subject of intense scientific debate and much scientific research is under way, especially by the WHO.

While the scientific debates have not yet come to a conclusion about the consequences of exposure over various time spans to electromagnetic fields of various intensities, it is as well to apply the precautionary principle and, especially for sensitive people, including children, to avoid as far as possible any unnecessary source of electromagnetic fields.

→ Electromagnetic pollution – in principal

Electromagnetic pollution comprises electrical and magnetic fields present in our environment that are not from natural sources.

The artificial sources are electrical and telecommunications installations. There are two major families of electromagnetic waves:

- **Low-frequency:** electrical and magnetic fields are present around every operating electrical appliance. Only electrical fields are present around electrical equipment that is connected but switched off.
- **High-frequency:** this is mainly linked to telecommunications, Hi-Fi equipment etc.

This pollution can come both from outside and inside. Major external sources are high voltage power lines, GSM antennae or tramways, as well as radio and TV signals. Internal sources include sources of pollution in the form of antennae, such as electrical plugs, unshielded TV cables etc., as well as wireless communications technologies (Wi-Fi, GSM). Thus, the question of electromagnetic fields covers a very wide range of technologies.

→ Useful measures to limit electromagnetic pollution

- Designing the installation of telecommunications and IT networks encasing cables in high-density partitions and routinely providing adequate earth protection;
- Providing new, interior partitions that absorb electromagnetic radiation;
- If possible, limiting the length of electric cables through suitable positioning of sockets;
- Shielding high current cables;
- Providing isolating relays to the circuits of all premises that do not require electrical equipment to be continuously operational.

→ Behavioural measures to limit electromagnetic pollution

For all electrical equipment, moving away is a real and effective preventive measure, because of the rapid reduction of the magnetic field. For use of computers in schools, it is best to choose:

- Energy-efficient equipment, as this generates less of an electromagnetic field;
- Computers with a separate keyboard, which thus maintains a certain distance;

1. COMFORT AND QUALITY OF LIFE



- Flat, LCD or plasma screens, which limit exposure as compared with cathode ray screens.

Note on the influence of computer and screens on children's learning and health

Some brain scientists, doctors, pediatricians and psychiatrists are worried today about the influence of digital media and screens on one hand, the development of the brain and memory and on the other hand, on the health of children (back pain, sleep disorders, vision problems, pathology of the hand ...). It is therefore essential to be cautious in the use of digital media in school.



1.8. Improving the quality-of-life in school

A person's quality of life can be defined according to a series of parameters linked to the quality of their external environment (built and unbuilt) and to the relationship a person has with their environment. These parameters are as follows:

- the quality of the immediate exterior environment: the presence of communal or meeting spaces, public spaces and green areas;
- the opportunity and ability to travel, safely, on foot or by bicycle;
- the presence of local services accessible on foot or by bicycle;
- the presence of a neighbourhood community life.

These various parameters will give the person living in a neighbourhood, or the user of the building in that neighbourhood, a feeling of belonging and of safety that it is necessary to the quality of life experienced.

1.8.1. Optimising the school's outdoor spaces

Taking part in varied leisure activities allows children to learn to cooperate, to respect differences to adapt to constraints and regulations, to savour success with modesty and to put their frustrations in perspective. In this way, they also develop their critical spirit, their creativity, their skills at negotiation, directing, controlling and evaluating activities. In a word, they learn to manage their environment in a respectful manner. Source: BOUCHARD Report (1991) A Quebec in Love with its Children, Report of the Working Group on Youth, Quebec, Ministry of Health and Social Services

School can be defined as a set of built and non-built spaces made available for the cognitive, sensory, social and affective development of children. The outdoor space is as important as the indoor space, as it aids children's social integration. In this framework, the games and physical activities that children pursue in the school playground constitute part of the educational activity of the school.

The playground is a place essential to the proper operation of a school. In the morning, it is where the children have their first contact with the school environment. At lunchtime, it is used as a meeting place, for leisure activities and relaxation. It is also the place children are sent to between classes (playtime) so that they can amuse and re-energise themselves. Finally, it is the place for coming together and meeting their parents again at the end of the day. The following are a school's outdoor areas: playground(s), reception and entrance area, school entrances, car park, driveway etc. and the areas adjacent to the school.

We shall only deal here with the improvement of the playground and planting to the areas adjacent to the school.

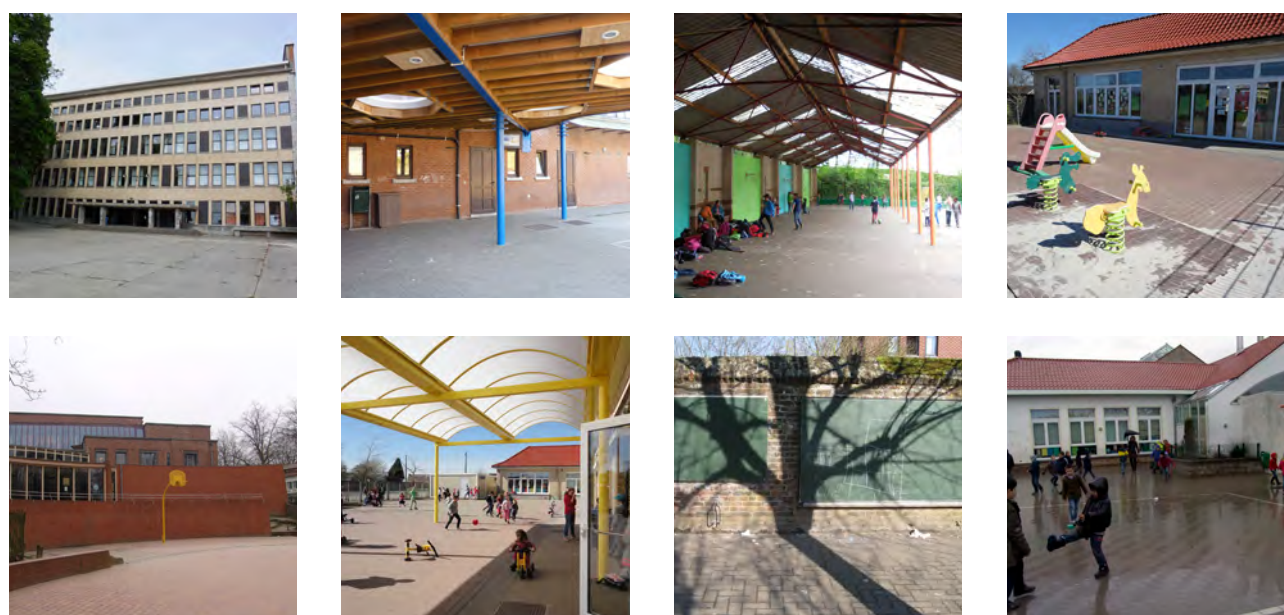

Different designs of playground and external spaces - Pictures : Catherine Massart and Coralie Cauwerts

SUSTAINABLE REFURBISHMENT OF SCHOOL BUILDINGS

1. COMFORT AND QUALITY OF LIFE



1.8.1.1. Playground

It is considered essential that children have the right to play. The United Nations (UN) mentions in its Declaration of the Rights of the Child «The child shall have full opportunity for play and recreation, which should be directed to the same purposes as education; ...»

→ The importance of play in school

Through play, children develop the foundations for a social life.

Play is first of all a response to the need to recharge one's batteries and to relax.

Lessons are synonymous with a lack of movement, prolonged sitting down, being required to carry out numerous tasks in an environment with a large number of other children and in a generally restricted space. Children (like adults), find these physical constraints are a source of tension, agitation and/or fatigue. Playtime allows children to meet the pressing need for physical relaxation, whether through movement (running, sliding, climbing, jumping etc.), or through rest, relaxation and seeking peace and quiet. Play also allows the child to relax psychologically and express their dreams and imagination.

Play is also a response to the need for spatial exploration.

While they are moving, children are learning to situate themselves physically in space. Through movement, children discover, experience and assimilate different directions and dimensions.

Play is also a response to the need to act on one's environment.

It is because children act on their environment that they can appropriate it. Children must be able to complete and add to installed play structures, or invent others: hopscotch, marbles or other temporary games. In this case, the time spent creating or setting up is as important as the time spent playing.

Ideally, the playground should be able to meet these fundamental needs through the layout of different areas.

→ What is a playground?

Given the poor play quality of the great majority of playgrounds, given the lack of colour or plants and their limited size, one might ask: «what is a playground?»

A playground is, first of all a safe space. This safety depends both on the area of the playground and the variety of ways it is arranged and equipped. It is essential that children, especially the smallest ones, have a feeling of safety and well-being when they meet in the playground, i.e. that the playground is arranged so as to provide them with the privacy necessary to feel at ease.

A playground is a space that provides various patterns of play equipment and markings to help the children's motor development. It must, therefore, be seen as a structured space with a mixture of play areas and areas for rest and discussion, spaces for group activities etc. The playground and its different areas must allow for exploration, experience, movement and establishing territories.

The playground is a space that provides various patterns of games to help children's socialisation. It should be seen as a place for learning, social relationships and observance of social rules. It should be organized in a way that allows a happy and relaxed atmosphere, where each child finds his or her place among the others. It should be arranged in a way that allows children to acquire a feeling of belonging: «it's my playground, I feel good, alone or with the others etc.» This feeling will have a considerable effect on the playtime atmosphere, children's mood and displays of aggression.

The playground is the extension of the classroom. The presence of Nature, a vegetable garden, or perhaps a small weather station, can encourage awakening of children's awareness, facilitating observation and experience outside the classroom and, thus, allowing learning about natural science.



Picture: Catherine Massart



Picture: © Ecole St Joseph - Uccle, Belgium

1. COMFORT AND QUALITY OF LIFE



→ Improving the playground space

In general, refurbishment projects for playgrounds happen when people involved in the school – often parents or resources personnel – identify a problem or shortfall (safety, lack of play equipment, worn out ground covering, lack of space etc.).

The fact that they want to solve these problems, often leads the school to undertake a more comprehensive project of playground development. When planning to improve the setting out of a playground, the following questions can be posed:

- Is the playground large enough given the number of pupils using it daily? Would it be possible to enlarge or extend it?
- Does the playground offer the children a suitable micro-climate (air quality, thermal and acoustic environment)?
- Does the current layout enable the pupils to be active and to relax without causing excessive quarrels or animosity?
- Is the layout consistent with the various school activities and the educational project?
- Is there any planting? Is it possible to conserve it?
- Is the playground equipment (play equipment, benches, tables etc.) safe?
- Are sanitary facilities near or at the playground in good condition and sufficient in number?

When a redesign project is proposed or launched, the quality of the proposed design should be assessed, in particular:

- Its reliability (soundness, service life of equipment, maintenance etc.);
- How well it complements the existing equipment;
- The diversity of ways it can be used.
- The age groups concerned (make sure that the equipment will cater for all the pupils using the school, possibly using different areas according to the ages of the pupils etc.)

→ Optimising the playground area and layout

Most of today's schools have playgrounds that are too small for the number of pupils using them. The playground is a special place for play and movement. It should, therefore, be of a size that takes into account a minimum area to be allotted per child. Various bodies specialising in early childhood advise minimum surface areas.

E.g.

The website www.sitecoles.org recommends:

- *Playgrounds for infants classes should have a play area based on the number of classes with a minimum of 400 m² for the first class and 100 m² for each additional class;*
- *Playgrounds for primary school classes should have a play area based on the number of classes with a minimum of 200 m² for the first class and 100 m² for each additional class.*

In Luxembourg, a minimum of 5 m² per child is considered necessary.

In France, each child has an area of between 3.8 m² and 4.5 m².

GERIS, a University of Quebec Social Policy research and study group, advises an area of 13.5 m², so that children can use their gross motor skills and really run.

An enclosed playground or shelter should also be provided at each playground. There are several possible layouts:

- a type of canopy the length of one of the school walls;
- open on three sides or adjoining the school building;
- closed on three sides and opening with wide doors on the fourth side. In this case, the enclosed playground can be completely closed, or even heated, during bad weather.

The surface area advised by the website www.sitecoles.org is:

- for infant classes : 100 m² up to 5 classes and 150 m² up to 8 classes.
- for primary classes : 0.80 m² to 1 m² per pupil

Larger surface areas meet children's needs better and give the playground a better functional quality. These more generous surface areas also limit the amount of aggressive play and arguments, by promoting cooperative play. Moreover, statistical studies show that accidents in playgrounds increase when there are too many children in relation to the playground surface area.

In principle, playground surface areas are standardised according to country. Nonetheless, they are not always achieved during refurbishment, whether due to lack of space or lack of financial resources.



Every school should have the possibility to divide its playground into different areas in order to facilitate organisation and supervision, while assuring children's safety.

Three types of space are generally essential for the children's proper development: the play area, the area for PE or sport and the rest area. These three areas can be complemented by a garden, kitchen garden or garden and pond. Each of these areas has specific characteristics (surface area, surfacing, furniture etc.), which must be taken into account during their setting out.

Each school, according to its geographic location, should take care to plan the setting out of the playground according to the climate, period of frost (e.g. greater in Denmark and Norway) and periods of sunshine (e.g. greater in Italy).

→ Optimising the playground micro-climate

The playground is often designed as an area circumscribed by a group of buildings.

According to its orientation, its exposure to the sun, the ground surfaces and facade finishes and presence of plants, the playground will have its own micro-climate. It is important to identify this according to the different seasons and playtime schedules, especially for the midday playtime (after the children's lunch) and at the end of the day for after-school care.

The playground should be useable in all seasons.

While the children's thermal comfort is crucial inside the buildings, it is also essential to take it into account for the playground, as children spend at least two to three hours a day in that space, in particular at midday

Midday can be an issue from May to October, when the sun is high in the sky, temperatures are high and there is little shade etc. During the summer heat, the playground surface, if it has a dark-coloured, mineral surface and no shade or vegetation, can have a temperature of around 40°C or more.

Playground air quality should be taken into account during school refurbishment. In fact, during the play and physical activities that take place in the playground, children inhale larger quantities of air than when they are in class (sedentary activities). Playground air quality depends upon the geographical location (proximity to heavy traffic routes, industrial sites, town centre, in the countryside etc.), but also upon the presence of vegetation or trees which, at some times of year, can be a source of pollen emission.

→ Optimising acoustic comfort in the playground

School playgrounds are generally considered to be a major source of noise nuisance for the vicinity. During playtime, for reasons that are both physiological and psychological, children shout.

During playground renovation, care should be taken to:

- give protection from prevailing winds;
- limit draughts;
- limit excessive contrasts of light;
- improve air quality.

A playground's micro-climate can be optimised in particular by:

- planting trees or areas of vegetation: shade and a refreshing effect in summer;
- choosing suitable ground surfacing: dark-coloured, mineral surface treatments are not recommended;
- avoiding reflective surfacings, finishes or materials (high-contrast of light).



Picture: © Ecole St Joseph - Uccle, Belgium



Picture: © Ecole St Joseph - Uccle, Belgium

SUSTAINABLE REFURBISHMENT OF SCHOOL BUILDINGS

1. COMFORT AND QUALITY OF LIFE



After having been kept quiet and still during lessons, it is normal that children let off steam, move, run and shout etc.

However, children's shouting are not simply and entirely beneficial, and many of the children are disturbed by their classmates' noise. In addition, when playgrounds are located in a noisy environment (in the proximity of road traffic, town centre etc.) this makes the pupils shout louder to be heard above the ambient noise.

While it is legitimate to want to protect neighbours from playtime noise levels, it is also important and necessary to think of the consequences of the playground acoustic environment on children's behaviour (fatigue, agitation, aggression, increased conflict etc.) and the quality of recovery time and relaxation (increased stress).

Protecting the playground from surrounding noise nuisance

In the event of the site being an urban one or in the proximity of a major noise nuisance, care should be taken, during playground redesign, to limit this noise nuisance by installing effective noise barriers and planting non-deciduous plants or trees.

Managing playground acoustics

With regard to playground acoustics, the WHO recommends 55 dB as guidelines for level of ambient noise in outdoor areas. This level is proposed by the WHO because of the disturbance that can occur above that threshold, but it is relatively difficult to achieve this level in urban areas. Acoustic improvement of a playground starts with an improved spatio-temporal organisation:

- the use of the playground should be differentiated according to the ages of the children;
- for noisier forms of play, the choice of play equipment or markings and its siting should take account of the location of classrooms, so as not to disturb their use.

Finally, every designer should pay attention to the configuration, shape and choice of surface coverings in order to reduce acoustic reverberation. Adding vegetation (trees, bushes, kitchen garden, and lawns) can also improve playground acoustics.

→ Optimising illuminance in the playground

When the days get shorter, the use of artificial lighting becomes necessary. It enables playground supervision and safety. It also has a reassuring effect upon the children. The artificial lighting of the playground should also assure visual comfort for the children, teachers and supervisors when the playground is in use:

Adequate illuminance level

An adequate illuminance level to enable users to properly and easily distinguish other users, signage and any obstacles. If there is no specific legal requirement, the following illuminance levels should be provided:

- a minimum of 10 lux for circulation areas and routes;
- 40 lux for activity areas.

Adequate colour rendering

The colour rendering provided by exterior lighting must enable good colour recognition, thus enhancing the quality of perception of playground users. Preference should be given to choice of lights with a CRI (colour rendering index) greater than 60 and, ideally, of 80 (according to standard EN 12-193, 1999).



Picture : Catherine Massart



Picture : Catherine Massart



Choice and good positioning of lighting equipment

The power of bulbs, and the height and distribution of light fittings in the playground will strongly affect visual comfort, reduce energy consumption and maintenance costs. A selection of light fittings is given in Chapter B.

Light fittings should be sited to clearly distinguish between circulation routes and play areas.

1.8.1.2. Protecting and/or reinstating vegetation to the school

Plants and trees enable noticeable improvement to a playground's micro-climate, by providing shade to some places, by improving air quality through tree foliage refreshing and humidifying the air and by sedimentation of particles and dust contained in the air. This is in addition, to limiting overheating through planting lawns or soft landscaped areas, which heat up more slowly than hard landscaping. Vegetation is essential to the well-being of children and adults, especially in a very dense and very hard-surfaced urban environment. Indeed, this provides improved integration of the school within the district, makes the school appear more friendly and welcoming and creates interesting visual diversion from the classrooms.

School also has a role to play in offering children the chance to discover plant and animal species. Plants are also an educational tool: observation of the changing seasons, of species of animals and insects etc. Even beyond this, increasing the amount of vegetation, mainly in the open ground, also allows reintroduction of biodiversity, i.e. a large number of animal and plant species, rediscovering a balance between various existing ecosystems, as well as water management for part of the plot, by allowing rainwater infiltration.

Restoring vegetation to the school can be done in various ways:

- Planting soft landscaped areas in playgrounds. In this case, these areas can also be linked to rainwater management (see Chapter C) or wastewater recycling (see Chapter D);
- Installing kitchen garden areas or ponds to some external areas of the school. In this case, these spaces can also be linked to the school's educational project and enable different activities during lesson time and during playtime;
- Planting vegetation and trees in areas adjacent to the school: in car parks, in the entrance area etc.
- Planting green roofs, when roof design permits.

Planted areas provide added value for the quality-of-life of a building's occupants, with regard to both general well-being and comfort level. However, the maintenance of such areas can prove to be both extremely costly, wasteful of water and a major source of waste production. These areas can also affect air-quality and occupant health (pollen emissions). Therefore, the designer should be careful to choose plant species according to the following criteria:

- local species and species easily adaptable to the local climate;
- species whose pollen does not cause allergies or respiratory problems;
- species requiring little water;
- species requiring little maintenance.



Picture : Sylvie Rouché

→ Green or living roofs

In high density areas, or when there is a lack of space, one effective means of reintroducing plants and biodiversity is a green roof. A green roof is a flat or gently sloping roof covered with plants and the layers of material necessary for their proper growth. There are three types of green roof, according to the type of plants they support:

- Extensive green roof: little plant diversity, requires very little or no maintenance;
- Semi-extensive green roof (or semi-intensive): great diversity of plants, requires little maintenance;
- Intensive green roof: great diversity of plants, requires the same sort of maintenance as a traditional garden.

Green roofs have many advantages:

SUSTAINABLE REFURBISHMENT OF SCHOOL BUILDINGS

1. COMFORT AND QUALITY OF LIFE

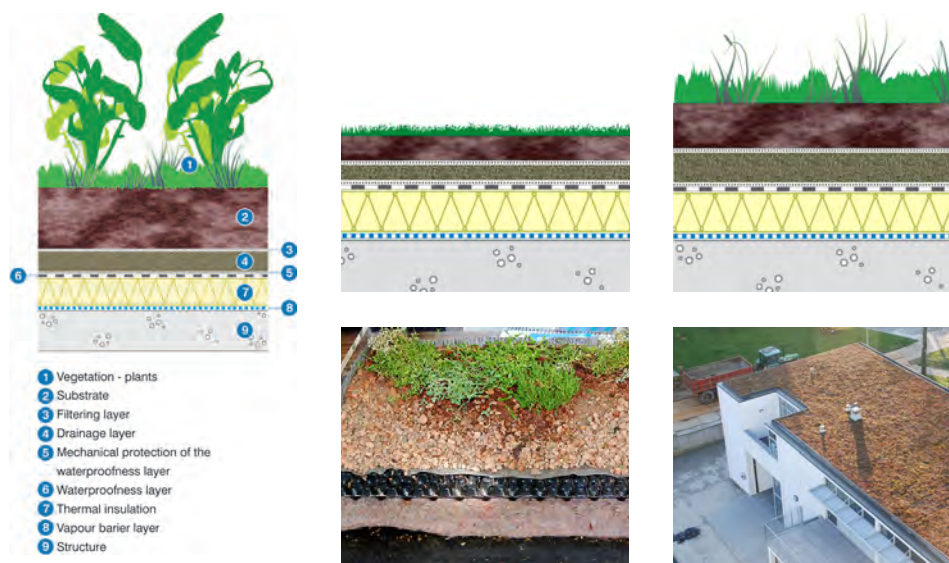

Extension of the roof service life

Green roofs extend the weather-tightness service life, thanks to the various layers of which they are composed and their contribution to thermal regulation:

- Weather-tightness is protected against the sun's ultraviolet rays and bad weather;
- Weather-tightness exposure to the ageing effect of temperature fluctuations is reduced;
- Weather-tightness is permanently protected against trampling and accidental impact.

Strengthening biodiversity

Green roofs, especially in high-density areas, such as town centres, are an effective way to reintroduce some biodiversity, by providing animal species with corridors and habitats (e.g. nesting etc.) and plant species with places to grow and multiply.

Rainwater management

Green roofs play an overriding role for rainwater management, especially in urban areas – increasingly soil-sealed – since they act as a buffer between the weather and the drainage system.

Improving air quality

Green roofs allow noticeable improvement to air quality, especially in high-density areas, by filtering some of the particles in the air, absorbing some heavy metals (atmospheric pollution), such as cadmium, copper, lead and zinc and by oxygenating the air through photosynthesis. Moreover, thanks to shading and evapotranspiration, a green roof improves the neighbouring hygrothermal air quality and micro climate.

Selection criteria	Extensive vegetation	Semi-intensive vegetation	Intensive vegetation
Refurbishment	YES	To be assessed	Difficult
Thickness	< 0.1m	0.1m - 0.25 m	> 0.25 according the type of plants
Plants	Mosses sedums and grasses	Extensive and intensive small plants	All traditional garden plants
Base	Flat roof or 2% – 70% slope	Flat roof or 2% – 57% slope	Flat roof 2% – 10% slope
Load-bearing structure	Normal	To be assessed	To strengthen
Service load	30 – 100 kg/m ²	100 – 400 kg/m ²	> 400 kg/m ²
Accessible	NO or just for maintenance	YES	YES
Extra cost (including structural reinforcement)	16% – 32% according to area	40%	40%
Impact on water cycle	Noticeable	Major	Major



Selection criteria	Extensive vegetation	Semi-intensive vegetation	Intensive vegetation
Impact on air quality	Noticeable	Major	Major
Acoustic insulation	Moderated	Moderated	Increased
Thermal insulation	Slight	Some	Noticeable
Implementation	Easy	More difficult	More difficult
Maintenance	Little or none	Regular	Major

Source: *Trachte Sophie, Advanced and Sustainable Housing Renovation – A Guide for designers and planners, AIE37, 2010*

1.8.2. Encouraging soft mobility for children and teachers

Nowadays, for both refurbishment and new-build construction, it is not enough to just improve the energy performance of buildings, whether residential or non-residential; one also has to take into account optimisation of the urban transport and soft mobility networks that serve them.

In fact, vehicle traffic is one of the main sources of urban nuisance and pollution: it is not just responsible for noise and taking up a large amount of space, but also for major toxic emissions (CO₂, SO₂, fine particles etc.).

Furthermore, vehicle traffic has played a principal role in the deterioration of public space, in the decline of social interaction and in the disappearance of the feeling of belonging to a local community, that of one's street, one's block, one's district etc.

For example, in Brussels, more than 35% of journeys to school are by car (INS, 1998-99). The average journey time between school and home is approximately 17 minutes¹. Yet, the distance between home and school is often short and the first kilometres driven are the most polluting. Moreover, car use is the source of congestion problems around schools, conflicts of use, discourtesy and insecurity.

Learning to use a different form of transport is an important element in the development of towns and districts, as well as in the physical development of children and their learning to be independent.

The journey to school gives each child a particular spatial experience with a double educative value: on the one hand, it contributes to individual appropriation of a territorial area, on the other hand, it is a way of learning about sociability in public areas².

Obviously, at the scale of a sustainable school refurbishment project, designers have no real influence on the management of pedestrian, cyclist or car journeys or on the efficiency of public transport. However, through suitable setting out of the areas around the school and providing bicycle shelters, they can influence or motivate the choice of the school's users and players to travel differently.

Moreover, the architecture of the built and non-built environment is liable to stimulate, facilitate and make safe pedestrian and cycle journeys, which play a role in urban vitality, local business and a feeling of security and safety.

1.8.2.1. Reducing car use, a pedagogical choice for the school

→ Role of parents and teachers

Parents have an intrinsically important role to play in their children's learning about mobility. In fact, even if the school is close to a public transport network or easily accessible on foot or by bicycle, that is not a sufficient condition to ensure the choice of those means of transport. First, it is necessary for the children to acquire the necessary skills to take the bus, tram or metro, for them to know their way around town and the various transport networks and, above all, that they wish to do so. This idea of wishing to do so suggests two things:

- the raising of awareness by parents and teachers;
- high-quality provision both in public and urban areas, and in public transport.

Parents and teachers can set an example, encouraging children to travel on foot, by bicycle or by public transport:

- by, themselves, travelling on foot or by bicycle when the distance to be travelled permits;
- by using these alternative means of transport during school journeys and visits. At the beginning of each year, each teacher can suggest to children and parents that they take out a public transport season-ticket. This is

1 Source: Amélia Ribeiro de Souza, «Les Chemins de l'école», UCL, Louvain University Press

2 Source: Amélia Ribeiro de Souza, «Les Chemins de l'école», UCL, Louvain University Press



- often free for children under 12 years old;
- by regularly suggesting to children that they travel to and from school on foot or by bicycle;
- by suggesting to children over 10 years old that they make certain journeys alone. From 9 to 12 years old, children begin to show their wish to travel alone, especially for going to school;
- by regularly suggesting to the children that they travel on foot or by bicycle for other weekly activities: shopping, doctor's appointment, sporting or cultural activity etc.
- by responding positively to children's requests to go to school by bicycle.

→ Raising awareness of this type of travel

School can, with the help and support of parents, become a place for raising awareness of this type of travel, by suggesting various forms of action:

- During lessons promoting psychomotor skills and gymnastics lessons, or during extracurricular activities, developing cycle training from infant school, using play circuits and handling skills;
- During the school year, organising one or two bicycle awareness days, dealing with the role of the bicycle as a sustainable and healthy means of transport, by proposing a cycle rally day open to all families;
- During the school year, organising one or more road safety awareness days, by offering either a circuit with road signs and challenges to foot and cycle traffic, or a route along roads and tracks

For this, the use of cameras or pictures will enable before and after identification of risk areas and road layouts and equipment helpful for cyclists.

1.8.2.2. Means to employ

→ Setting up a walking bus

A walking bus is a form of school transport with the following goals: limiting car use, encouraging maintenance of pupils' health and getting them to be physically active, making children aware of the positive effect of this type of transport and teaching them to be independent and giving them knowledge of the town or urban area.

The walking bus consists of collecting children on the way between home and school. Organised by volunteer parents, wearing high-visibility waistcoats with reflective strips, the groups of children assemble at fixed times and places.

In order to optimise this type of travel, it can be useful to set up a number of stops on the route, which allow the group of children to be reorganised and joined by others.

In France and Switzerland, there have been many guides written about methods of setting up this type of school transport (Ademe, pedibus Genève...)

→ Setting up a cycle train

The cycle train is similar to the walking bus; it is just children going to school by bicycle in a group organised by specially trained adults. A route, an exact timetable and stops are specified and everybody must observe them.

Children and supervisors have to wear helmets and high-visibility waistcoats with reflective strips and everyone must know the itinerary to be followed. All children, from the fourth year of primary school can join a cycle train, but it is useful, when planning this type of school transport, to provide a quick training for the children with the following goals:

- independence: having greater independence in journeys to school, leisure facilities etc.;
- encouraging responsibility: leading to good citizenship, safety and developing a sense of responsibility;



1. COMFORT AND QUALITY OF LIFE



- health: improving the general state of physical health and develop skills in effort control;
- personal development: reinforcing a positive image and experiencing overcoming personal limits;
- environment and lifestyle: developing thought and action about one's environment.

Setting up and succeeding with this type of travel requires motivation of all players in the school. This project must be well thought out, prepared and managed during the school year. It is also desirable to involve the police and the local authority.

→ Providing cycle sheds in and adjacent to the school

If one wants to encourage travel by bicycle, it is crucial to provide cycle sheds or racks in the playground or in the outside circulation areas of the school.

Siting

In order to not discourage cyclists who have already put in an effort, and in order to limit any thefts, cycle sheds or racks should be situated close to school entrances, in an area with high natural surveillance. Dark and secluded areas should be avoided. Access to them should be safe, secure and without obstacles (steps, kerbs, excessively steep slope etc.). If the cycle sheds or racks are close to a car park, physical separation must be provided and/or ground markings for separation.

Number of spaces to provide

The number of cyclists is greater in summer and springtime it than in winter. The number of spaces should be calculated according to a quick survey of pupils and parents and according to the period of heaviest use, allowing for some spaces for occasional cyclists (parents or visitors).

Design

In general, cycle sheds and racks should be user-friendly, lit, sheltered and secure. Bicycles should, ideally, be protected from wind and inclement weather. To avoid theft, racks must allow the front wheel and frame to be locked. Care should be taken to provide sufficient space between racks and around them, so that bicycles can be easily manoeuvred. The ideal type of rack is one that allows the bicycle to be easily slotted in without having to be lifted. The rack must be solid and durable and secured to the ground.

Cost

Equipment	Costs (excl.VAT) inclusive of installation <i>per bicycle</i>
Arch	50 - 55 euros
Bicycle rack	30 - 40 euros
Hanging rack	40 - 50 euros
Bicycle shed (cage)	300 - 900 euros
Bicycle shelter	130 - 220 euros
Masonry-built shed	1300 - 1600 euros

Source: Guide Pratique pour la construction et la rénovation de petits bâtiments, recommandation pratique TER03, IBGEBIM, Bruxelles



Picture : Catherine Massart



Picture : Catherine Massart

1. COMFORT AND QUALITY OF LIFE

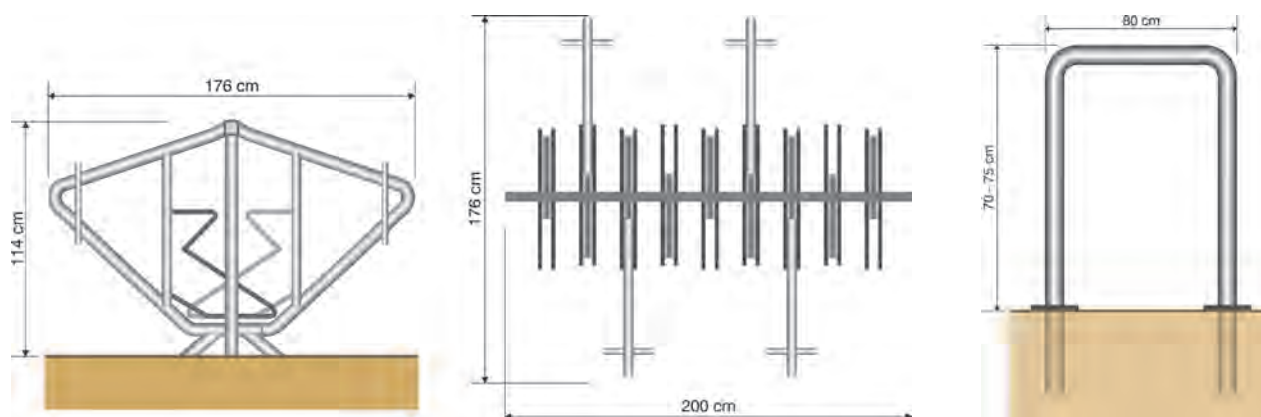

→ Secure area and access close to the school

Security arrangements around schools have their role to play with regard to the issue of school travel. They must give good support to the efforts already undertaken by the school and encourage action by the various school players.

The layout of the areas around a school should meet several goals, the first of which is children's safety.

Other essential goals can be inherent to the layout of the areas around schools: more equitable sharing of public space can lead to greater security and safety for pedestrians or cyclists; assuring the user-friendliness of the areas around schools will be a benefit to all members of the public, as schools are still, for the most part, in the centre of towns and villages.

Pursuing these goals, it is important to:

- Improve the school's visibility in the district through signage (panels and on the ground) and adequate lighting.
- Limit vehicle speeds in the proximity of the school, by creation of zones with reduced speed limits (30 km/h zone);
- Managing and organising parking within a radius of 500 m around the school;
- Setting out the pavements and public space within a radius of 500 m around the school (lighting, security barriers, ground markings etc.).

This can only be achieved by close collaboration with the local or regional authorities, as the school does not own the public space.

→ Setting out a drive-in or drop-off zone

Drop-off zones may be instituted in front of some local schools. The point of this type of zone is to secure areas adjacent to schools during rush-hour, to avoid traffic jams, double parking, pavement parking, parking on pedestrian crossings etc. These zones must be considered as very short stop zones, enabling the child to get out of the vehicle and to safely enter the school. Raising awareness of parents is essential to optimise this type of zone and its use.



Picture : Sylvie Rouche



Picture : Sylvie Rouche



1.8.3. Encouraging exchange and interactions between the school and its immediate environment

The relationship between the school and its environment has developed in line with political visions of education and obvious social phenomena. Originally, schools were built according to a design of school buildings turned in upon themselves, proof against the disturbance of their environment and facilitating the transfer of knowledge from master to pupils, whatever their status; the school today is considered to be a defining element of a district or town.

It has the benefit of an area of influence around its site, particularly because of the traffic it generates and the various activities it offers over and above teaching.

The school also brings together on its premises a large public, adults and children, young and not so young, sometimes from different social classes.

In terms of sustainable refurbishment, it is thus essential to think about how the school can interact with its immediate built or social environment.

- The proposals below need to be thought about in collaboration with various players: local authority, population, shopkeepers, teachers and school management etc. and according to the operational opportunities, both of the neighbourhood and the school:
- Homework school for all the neighbourhood children;
- Shared spaces: sports hall, school hall, outdoor play areas, outdoor sports fields;
- Opening the school for particular neighbourhood events;
- Shared, neighbourhood activities: jumble sales, film screenings, theatre etc.



1.9. Comfort and quality of life - Breeam assessment method

To assess comfort and quality of life, BREEAM assessment method proposes 6 criteria listed under the environmental section «HEALTH and WELLBEING» :

- HEA 01: Visual comfort
- HEA 02: Indoor Air Quality
- HEA 03: Thermal Comfort
- HEA 04: Water quality
- HEA 05: Acoustic performance
- HEA 06: Safety and security

This section «HEALTH and WELLBEING» represents a weighting of 15% in the evaluation.

But chapter «Comfort and quality of life» also includes criteria that can be found in BREEAM sections: «MANAGEMENT», «ENERGY», «TRANSPORT» and «LAND USE AND ECOLOGY» with a weighting of 12%, 19%, 8% and 10% in the evaluation. Therefore, an overview of these criteria will also be presented below.

For additional information : <http://www.breeam.org/page.jsp?id=381>

1.8.1. HEA 01 - Visual Comfort

This issue aims to ensure daylighting, artificial lighting and occupant controls are considered at the design stage to ensure best practice visual performance and comfort for building occupants. This issue is **mandatory** to achieve a minimum standard and split into five parts:

Criteria	Number of credits	Explanation
Pre-requisite	/	All fluorescent and compact fluorescent lamps are fitted with high frequency ballasts.
Daylighting	1 - 2 credits	<p>Daylight factor required: 2% Area to comply : 80% Other requirements:</p> <ul style="list-style-type: none"> - A uniformity ratio of at least 0.4 or a minimum point daylight factor of at least 0.8% (spaces with glazed roofs, such as atria, must achieve a uniformity ratio of at least 0.7 or a minimum point daylight factor of at least 1.4%). Due to particular lighting issues in teaching spaces the uniformity ratio can be reduced to 0.3 - A view of sky from desk height (0.7m) is achieved - The room depth criterion $d/w + d/HW < 2/(1-RB)$ is satisfied. Where: <ul style="list-style-type: none"> d = room depth, w = room width, HW = window head height from floor level, RB = average reflectance of surfaces in the rear half of the room,
Glare control and view out	1 credit	<p>Glare control: the potential for disabling glare has been designed out of all relevant building areas either through building layout and/or building design.</p> <p>The glare control strategy should be developed in tandem with the lighting strategy to ensure that glare is minimised whilst avoiding potential conflict with the lighting control systems, therefore avoiding higher than expected energy consumption</p> <p>View out: all positions within relevant building areas are within 7m of a wall which has a window or permanent opening that provides an adequate view out. The window/opening must be $\geq 20\%$ of the surrounding wall area</p>
Internal and external lighting	1 credit	<p>Internal lighting: Illuminance (lux) levels in all internal relevant building areas of the building in accordance with European Standard.</p> <p>Zoning and occupants control Manual lighting controls should be easily accessible for the teacher whilst teaching and on entering/leaving the teaching space.</p> <p>External lighting Illuminance levels for lighting in all external areas</p>

1. COMFORT AND QUALITY OF LIFE



1.8.2. HEA 02 - Indoor Air Quality

This issue aims to recognise and encourage a healthy internal environment through the specification and installation of appropriate ventilation, equipment and finishes. This issue is **not mandatory** to achieve a minimum standard and it is split into three parts:

Criteria	Credits	Explanation
Minimising sources of air pollution	3 credits	<p>Different requirement levels are proposed to achieve 1, 2 or 3 credits.</p> <p>The minimum requirements (for 1 credit) are:</p> <ul style="list-style-type: none"> - production of an indoor air quality plan - for air-conditioned and mixed-mode buildings: the building's air intakes and exhausts are over 10m apart to minimise recirculation and intakes are over 20m from sources of external pollution; - for naturally-ventilated buildings: openable windows/ventilators are over 10m from sources of external pollution; - the building has been designed to provide fresh air and minimise internal pollutants (and ingress of external polluted air into the building) in accordance with the criteria of the relevant standard for ventilation; - areas of the building subject to large and unpredictable or variable occupancy patterns have CO2 or air quality sensors
Potential for natural ventilation	1 credit	<p>Occupied spaces of the building are designed to be capable of providing fresh air entirely via a natural ventilation strategy.</p> <p>The natural ventilation strategy is capable of providing at least two levels of user-control on the supply of fresh air to the occupied space, as follows;</p> <ol style="list-style-type: none"> a. Higher level: higher rates of ventilation achievable to remove short-term odours and/or prevent summertime overheating b. Lower level: adequate levels of draught-free fresh air to meet the need for good indoor air quality throughout the year, sufficient for the occupancy load and the internal pollution loads of the space. <p>Any opening mechanisms must be easily accessible and provide adequate user-control over air flow rates to avoid draughts.</p>
Laboratory fume cupboard and containment areas	2 credits	<p>Where fume cupboards are specified, they are manufactured and installed in accordance with the following;</p> <ol style="list-style-type: none"> a. General purpose fume cupboards: EN 14175-2:200326 b. Recirculatory filtration fume cupboards c. Microbiological safety cabinets: EN 12469:200028 <p>Where ducted fume cupboards are specified, the discharged velocity from the extract fan stack from a ducted fume cupboard must be $\geq 10\text{m/s}$ as recommended by BS EN 14175-230.</p>

1.8.2. HEA 03 - Therma Comfort

This issue aims to ensure that appropriate thermal comfort levels are achieved through design and controls are selected to maintain a thermally comfortable environment for occupants within the building. This issue is **not mandatory** to achieve a minimum standard.

Criteria	Credits	Explanation
Thermal comfort	2 credits	<p>Different requirement levels are proposed to achieve 1 or 2 credits.</p> <p>The minimum requirements (for 1 credit) are:</p> <ul style="list-style-type: none"> - thermal modelling has been carried out using software - the modelling demonstrates that the building design and services strategy can deliver thermal comfort levels in occupied spaces - the software used to carry out the simulation at the detailed design stage provides full dynamic thermal analysis. - the TOR metric (%) is reported, via the BREEAM scoring and reporting tool, based on the modelling above and includes maximum and minimum temperatures for both summer and winter settings.

SUSTAINABLE REFURBISHMENT OF SCHOOL BUILDINGS

1. COMFORT AND QUALITY OF LIFE



1.8.4. HEA 04 - Water quality

This issue aims to minimise the risk of water contamination in building services and ensure the provision of clean, fresh sources of water for building users. This issue is **mandatory** to achieve a minimum standard:

Criteria	Credits	Explanation
Water quality	1 credit	<p>Building services water systems: minimising risk of contamination All water systems in the building are designed to avoid the risk of legionella bacteria in water systems. Where humidification is required, a failsafe humidification system is provided.</p> <p>Building occupants: Provision of fresh drinking water A wholesome supply of accessible, clean and fresh drinking water is supplied., <i>For schools:</i> <i>Chilled, mains-fed point-of-use water coolers accessible to pupils/students/users/staff throughout the day.</i> <i>Provision in safe and convenient locations e.g. dining/assembly halls, classrooms/common rooms, wide corridors, indoor social areas, changing rooms/gym-nasia, concourse.</i> <i>One compliant point-of-use water cooler is provided for every 200 building users, subject to a minimum of one water cooler being provided for any building with less than 200 building users.</i> <i>All coolers must be attached to both the wall and the floor to prevent vandalism, and contain security covers to protect all water and electrical connections.</i></p>

This issue must be related to Chapter 3 « Reduce resources consumption»

1.8.5. HEA 05 - Acoustic performance

This issue aims to ensure the buildings' acoustic performance including sound insulation meet the appropriate standards for its purpose. This issue is **not mandatory** to achieve a minimum standard and it is split into two parts:

Criteria	Number of credits	Explanation
Pre-requisite	/	<p>A qualified acoustician is appointed by the client at the appropriate stage of the project to provide early advice on influencing outline design solutions to :</p> <ol style="list-style-type: none"> External sources of noise impacting the chosen site Site layout and zoning of the building for good acoustics Acoustic requirements for users with special hearing and communication needs, Acoustic treatment of different zones and facades.
Acoustic performance standards - for school	3 credits	<p>The building meets the acoustic performance standards and testing requirements</p> <p>Achieve the performance standards required (1 credit) A programme of pre-completion acoustic testing is carried out by a compliant test body to ensure that the relevant spaces (as built) achieve the required performance standards. Where testing identifies that spaces do not meet the standards, remedial works are carried out prior to handover and occupation.</p> <p>Rain noise insulation (1 credit) Rain noise - For roofs with a mass per unit area less than 150kg/m²(light-weight roofs) or any roofs with glazing/rooflights, calculations or laboratory data are required for teaching/learning spaces to demonstrate that the reverberant sound pressure level in these rooms are not more than 20dB above the indoor ambient noise level, in case of heavy rain.</p> <p>All music accommodation or multi-purpose halls in primary schools with no music accommodation (1 credit) Where noise levels are expected to exceed 95dBA (e.g. in the case of amplified music and/or percussion) the design team must demonstrate that the need for higher sound insulation has been designed out through careful space planning.</p>



1.8.6. HEA 06 - Safety and security

This issue aims to recognise and encourage effective design measures that promote low risk, safe and secure access to and use of the building. This issue is **not mandatory** to achieve a minimum standard.

Criteria	Credits	Explanation
Safety and security	2 credits	<p>Safe access (1 credit)</p> <p>Where external site areas form part of the assessed development the following apply:</p> <ul style="list-style-type: none"> - Dedicated cycle lanes are provided and have been designed and constructed - The cycle lanes provide direct access from the site entrance(s) to any cycle storage facilities provided, without the need to deviate from the cycle path and, if relevant, connects to offsite cycle paths where these run adjacent to the development's site boundary. - Footpaths on site provide direct access from the site entrance(s) to the building entrance(s) and connect to public footpaths off site (where existing), providing access to local transport nodes and other offsite amenities (where existing). - Where provided, drop-off areas are designed off/adjoining to the access road and provide direct access to pedestrian footpaths, therefore avoiding the need for the pedestrian to cross vehicle access routes. - Where a dedicated pedestrian crossing of a vehicle access route is provided, the road is raised to the pavement level (i.e. the pavement is not lowered to road level), unless pavement is at road level (this may be the case in some car parks). - For large developments with a high number of public users/visitors, pedestrian pathways must be signposted to other local amenities off site, including public transport nodes (where existing). - The lighting for access roads, pedestrian areas, footpaths and cycle lanes is compliant with the external lighting criteria defined in HEA1. <p>Security of site and building (1 credit)</p> <ul style="list-style-type: none"> - The project team have accounted for security considerations in the building design and site layout through consultation with a suitably qualified security consultant. - Consultation with the suitably qualified security consultant occurred during or prior to the concept design stage or equivalent. - The final design embodies the recommendations/solutions of the suitably qualified security consultant and is built to conform.

1.8.7. MAN 04 - Stakeholder participation

This issue aims to design, plan and deliver accessible functional and inclusive buildings in consultation with current and future building users and other stakeholders. This issue is **mandatory** (only the criteria «Building user information») to achieve a minimum standard and it is split into four parts:

Criteria	Credits	Explanation
Consultation	1 credit	<p>During the preparation of the brief, all relevant parties and relevant bodies are identified and consulted with by the design team.</p> <p>A consultation plan has been prepared and includes a timescale and methods of consultation for all relevant bodies and how the relevant parties will be kept informed about progress on the project.</p> <p>The minimum consultation content has been covered</p> <p>During the design stage, consultation feedback has been given to and received by all relevant parties regarding suggestions made, including how the results of the consultation process have influenced, or resulted in modifications to, the proposed design and building operation/use.</p> <p>The project team ensures that through consultation and the resulting measures taken any areas or features of historic/heritage value are protected.</p>

SUSTAINABLE REFURBISHMENT OF SCHOOL BUILDINGS

1. COMFORT AND QUALITY OF LIFE



Inclusive and accessible design	1 credit	
Building user information	1 credit	<p>Building User Guides are provided and are appropriate to all users of the building (general users including staff as well as the non technical facilities management team/building manager).</p> <p>The Guides cover all functions and uses of the building, ensuring building users are able to use the building effectively. Where relevant, the documents must describe the facilities to be shared and how access to them will be arranged for potential users.</p> <p>Building and site related information is made readily available to all future building users, enabling them to access and use the building, site and local transport infrastructure/amenities effectively.</p>
Post Occupancy Evaluation (POE) and information dissemination	1 credit	

1.8.8. ENE 01 - Reduction of emissions

This issue aims to recognise and encourage buildings designed to minimise operational energy demand, consumption and CO2 emissions. This issue is **mandatory** to achieve a minimum standard and provides a maximum of 15 credits.

Criteria	Credits	Explanation
Accessibility index	1 to 15 credits	<p>To obtain credits, an Energy Performance Ratio (EPR) must be calculated. The calculation takes account of the following parameters;</p> <ul style="list-style-type: none"> - the building's operational energy demand, - the building's primary energy consumption - the total resulting CO2 emissions. <p>The calculation is determined using the following performance data from energy modelling of the building's specified/designed regulated fixed building services and fabric, as undertaken by an accredited energy assessor using approved building energy calculation software.</p> <p>The credits are obtained according to the energy performance:</p> <ul style="list-style-type: none"> - 1 credit : EPR of 0.06 - 5 credits: EPR of 0.30 - 6 credits: EPR of 0.36 and 25% reduction in CO2 emissions arising from regulated building energy consumption. - 10 credits : EPR of 0.60 and 40% reduction in CO2 emissions arising from regulated building energy consumption. - 15 credits : EPR of 0.90 and 100% reduction in CO2 emissions arising from regulated building energy consumption.

1.8.9. TRA 01 - Public transport accessibility

This issue aims to recognise and encourage development in proximity of good public transport networks, thereby helping to reduce transport-related pollution and congestion. This issue is **not mandatory** to achieve a minimum standard and it is split into two parts:

Criteria	Credits	Explanation
Accessibility index	1 to 3 credits	<p>The public transport Accessibility Index (AI) for the assessed building is calculated and BREEAM credits awarded in accordance with building types.</p> <p>The Accessibility Index is determined by entering the following information in to the BREEAM Tra 01 calculator:</p> <ul style="list-style-type: none"> - the distance (m) from the main building entrance to each compliant public transport node - the public transport type(s) serving the compliant node e.g. bus or rail - the average number of services stopping per hour at each compliant node during the standard operating hours of the building for a typical day

SUSTAINABLE REFURBISHMENT OF SCHOOL BUILDINGS

1. COMFORT AND QUALITY OF LIFE



Dedicated bus service	1 credit	For buildings with a fixed shift pattern i.e. where building users will predominantly arrive/depart at set times, one credit can be awarded where the building occupier will provide a dedicated bus service to and from the building at the beginning and end of each shift/day. The bus must provide transfer to the local population centre, public transport interchange or be a door-to-door service.
-----------------------	----------	--

1.8.10. TRA 03 - Cyclist facilities

This issue aims to encourage building users to cycle by ensuring adequate provision of cyclist facilities. This issue is **not mandatory** to achieve a minimum standard.

Criteria	Credits	Explanation
Cyclist facilities	1 to 2 credits	<p>Credits are obtained depending on the type of building, on number of classes (for schools) and the cycle facility requirements:</p> <p><i>E.G.</i></p> <p><i>Where a primary school has been designed to accommodate 3 classes per year, a total of 15 compliant cycle storage spaces are provided for the whole school. Where there are varying numbers of forms/classes per year, the calculation must be based on the year with the greatest number of classes/forms.</i></p> <p>The design of cycle storage must follow certain specifications in terms of lighting, covering, distance from the entrance...</p>

1.8.11. TRA 05 - Travel Plan

This issue aims to recognise the consideration given to accommodating a range of travel options for building users, thereby encouraging the reduction of user reliance on forms of travel that have the highest environmental impact. This issue is **not mandatory** to achieve a minimum standard.

Criteria	Credits	Explanation
Travel Plan	1 credit	<p>A travel plan has been developed as part of the feasibility and design stages which considers all types of travel relevant to the building type and users.</p> <p>The travel plan is structured to meet the needs of the particular site and takes into consideration the findings of a site-specific transport survey and assessment that covers the following (as a minimum):</p> <ul style="list-style-type: none"> - <i>Where relevant, existing travel patterns and opinions of existing building or site users towards cycling and walking so that constraints and opportunities can be identified</i> - <i>Travel patterns and transport impact of future building users</i> - <i>Current local environment for walkers and cyclists (accounting for visitors who may be accompanied by young children)</i> - <i>Disabled access</i> - <i>Public transport links serving the site</i> - <i>Current facilities for cyclists</i> <p>The travel plan includes a package of measures that have been used to steer the design of the development in order to meet the travel plan objectives and minimise car-based travel patterns.</p> <p>Where appropriate to the building type, size and intended operation, the travel plan includes measures tailored to minimise the impacts of operational-related transport e.g. deliveries of supplies, equipment and support services to and from the site.</p> <p>Where the building's final occupier is known, they confirm that the travel plan will be implemented post construction and supported by the building's management during building operation.</p>

SUSTAINABLE REFURBISHMENT OF SCHOOL BUILDINGS

1. COMFORT AND QUALITY OF LIFE



1.8.12. LE 04 - Enhancing site ecology

This issue aims to recognise and encourage actions taken to maintain and enhance the ecological value of the site as a result of development. This issue is **not mandatory** to achieve a minimum standard.

Criteria	Credits	Explanation
Enhancing site ecology	1 to 3 credits	<p>For one credit:</p> <ol style="list-style-type: none"> 1. A suitably qualified ecologist (SQE) has been appointed to report on enhancing and protecting the ecology of the site. The SQE must provide a report, based on a site visit/survey by the SQE, with appropriate recommendations for protection and enhancement of the site's ecology. 2. The general recommendations of the Ecology Report for enhancement and protection of site ecology have been, or will be, implemented. <p>For one more credit:</p> <p>Criteria 1 and 2 achieved</p> <p>The recommendations of the Ecology Report for enhancement and protection of site ecology have been implemented, and the suitably qualified ecologist confirms that this will result in an increase in ecological value of the site up to 6 plant species. The increase in plant species has been calculated.</p> <p>For two more credits:</p> <p>Criteria 1 and 2 achieved</p> <p>The recommendations of the Ecology Report for enhancement and protection of site ecology have been implemented, and the suitably qualified ecologist confirms that this will result in an increase in ecological value of the site of 6 plant species or greater. The increase in plant species has been calculated.</p>

SUSTAINABLE REFURBISHMENT OF SCHOOL BUILDINGS

2. SERVICES AND ENERGY EFFICIENCY

1.	Preamble	157
2.	Optimising the existing heating system	157
2.1.	Preliminary comments	158
2.2.	Assessing condition and efficiency of the heating system	159
2.2.1.	Heat generation	160
2.2.2.	Heat distribution and emission	161
2.3.	Replacing the heating generation system	161
2.4.	Optimising the heating distribution system	162
2.5.	Optimising the heat emission and heating units	163
2.6.	Designing a regulation system of the heating system	164
2.6.1	General information	163
2.6.2.	More precisely	165
2.7.	Improving the upkeep and the maintenance	170
3.	Optimising the production of sanitary hot water	172

Ecole Marcel Pagnol à Cannes - www.soltech.be

4.	Heating generation by heat pump in school renovation	174
4.1.	Principles	174
4.2.	Various system	175
4.2.1	The cold source or heat generator	175
4.2.2.	The hot source or heating units	178
4.2.3.	Types of circuit	179
4.2.4.	Operating methods	179
4.2.5.	Heat pump reversibility	180
4.3.	Installation	180
4.4.	Production of sanitary hot water	181
4.5.	Advantages and disadvantages of heat pumps	182
4.5.1.	Advantages	182
4.5.2.	Disadvantages	182
5.	Using solar energy for production of sanitary hot water	183
6.	Optimising the artificial lighting in classrooms	184
6.1.	Basic principles	184
6.1.1.	Basic characteristics of visual comfort	184
6.1.2.	Lamp characteristics	184
6.1.3.	Light fitting characteristics	187
6.1.4.	Lighting types of systems	187
6.2.	Composition of a lighting system	188
6.3.	The luminous source or lamp	188
6.3.1.	Types of lamp installed in classrooms	188
6.4.	Auxiliary components	189
6.5.	Types of light fitting and their components	190
6.6.	Types of control or management	191
6.6.1.	Principles of control	191
6.6.2.	Types of management	193
6.6.3.	Control devices	194
6.7.	Assessment of existing installation	195
6.7.1.	Assessment of visual comfort	195
6.7.2.	Energy efficiency assessment of the installation	196
6.8.	Optimisation of the classroom lighting installation	197
6.8.1.	Setting goals	197
6.8.2.	Types of renovation proposed	197
6.8.3.	Lamp replacement	198
6.8.4.	Ballast replacement	198
6.8.5.	Replacement of optical elements	199
6.8.6.	Improving control and management of the system	199
6.8.7.	Improving the maintenance	200
7.	Electricity production through cogeneration systems	201
8.	Electricity production from renewable sources	203
8.1.	Preliminary remarks	203
8.1.1.	Operating principle	203

8.2.	General concepts : silicon wafers - cell / panel - generator	204
8.3.	Photovoltaic cell	205
8.3.1.	Types of cell	205
8.3.2.	Operation of a crystalline solar cell	206
8.3.3.	Maximum power	207
8.3.4.	Current and voltage	207
8.3.5.	Effect of temperature	207
8.4.	Panel	208
8.5.	Inverter	209
8.5.1.	Possible configurations	210
8.5.2.	Assembly and connection	211
8.6.	Designing a photovoltaic system for a refurbishment project	212
8.6.1.	Choosing the panels' position	212
8.6.2.	Choice of panels and connection	215
8.6.3.	Choice of inverter	215
8.6.4.	Upkeep and maintenance	215
8.6.5.	Photovoltaic systems and grey energy	216
8.6.6.	IEA Task 47 - Cases studies	216
9.	Heat recovery from a ventilation system	217
9.1.	Principles	217
9.2.	Heat recovery exchanger	218
9.2.1.	Types of heat exchanger	218
9.2.2.	Characteristics of each type	220
9.2.3.	Performance and energy gain	220
9.3.	Installation in refurbishment	220
9.3.1.	The building may have a mechanical heat recovery ventilation system without heat recovery exchanger	220
9.3.2.	The building may have no ventilation system	221
9.4.	Maintenance	221
10.	Preheating / precooling of air by underground heat exchanger	222
11.	Services and energy efficiency - Breeam assessment method	223
11.1.	ENE 02 - Energy monitoring	223
11.2.	ENE 03 - External lighting	223
11.3.	ENE 04 - Low and zero carbon technologies	224
11.4.	ENE 07 - Energy efficient laboratory systems	225

SUSTAINABLE REFURBISHMENT OF SCHOOL BUILDINGS

2. SERVICES AND ENERGY EFFICIENCY



2.1. Preamble

In the context of sustainable refurbishment of school buildings, optimising or installing efficient building services means providing a suitable response to occupants' needs, improving building services, reducing the number of items of equipment or systems and facilitating their regulation and daily use. This also means ensuring that they consume little energy and produce little pollution.

By building services, we mean ventilation, heating, cooling, sanitary hot water and artificial lighting.

By equipment, we mean heating equipment (boilers etc.), pipework, distribution equipment and heaters or heating units.

By management system, we mean regulatory equipment (thermostats, valves, sensors etc.).

It is not possible to optimise all the building services without first having optimised the building envelope.

Optimising the envelope and building services enables, on the one hand, reduction of fossil fuel consumption and, on the other hand, noticeable improvement to the comfort of school users while, at the same time, considerably reducing operation and maintenance costs.

We shall, thus, take as our initial premise that, before optimising a school's building services, it is first necessary to:

- **Reduce heating, cooling and artificial lighting requirements by optimising the volume, spatial layout and external envelope of the buildings;**
- **Make maximum use of natural or existing sources of heating, cooling and lighting;**
- **Integrate and make maximum use of renewable energy sources.**

Three technical aspects need to be addressed as priorities in school building refurbishment, both for improving teaching and learning comfort, and for reducing energy costs and environmental impact. These are:

- The heating system and its regulation;
- The ventilation installation and its regulation;
- The artificial lighting installation and its control.

Regulation and adjustment of services plays an overriding role with regard to both comfort levels and energy saving.

2.2. Optimising the existing heating system



In Europe and the Scandinavian countries, schools have high energy consumption, which is mainly associated with buildings and premises heating. This has the consequence of noticeable increases in their running costs and their environmental impact (particularly greenhouse gas emissions).

E.g.

In 2006, the energy consumption of the Brussels education sector was 561.44 GWh. This represents 2.31% of all energy consumption for the Region and 7.24% of total consumption for the tertiary sector.

The energy consumption of a school has a very specific profile. Within its buildings, the most energy intensive item is heating (75%), followed by lighting (15%) and electrical equipment (10%).

Average consumption per pupil is 1.066 kWh of heating and 223 kWh of electricity per year. Each pupil, thus, generates a total annual emission of over 260 kg of CO₂. In other words, a school with 1000 pupils emits 260 tonnes of CO₂ per year.

Source: www.ibgebim.be

Most school building heating installations are old and poorly maintained. They are often inefficient and few of them possess a regulatory system suited to occupants' requirements.

The following are the types of heating installation frequently found:

SUSTAINABLE REFURBISHMENT OF SCHOOL BUILDINGS

2. SERVICES AND ENERGY EFFICIENCY



- **Central Europe:** gas- or oil-fired centralised systems with heat distribution via a network of hot water pipes to radiators or underfloor heating;
- **Southern Europe:** **TO BE COMPLETED** by experts
- **Scandinavian countries:** **TO BE COMPLETED** by experts

All these installations are mainly gas- or oil-fired, or electrical and exhibit major problems:

- little or no insulation;
- little or no regulation;
- high levels of fossil fuel consumption;
- high levels of air pollutant emissions (CO₂, SO₂, fine particles etc.).

Thus, it is important or even mandatory to optimise or improve existing installations in the context of sustainable refurbishment. For a heating installation, four aspects of the system need to be evaluated, optimised and/or replaced. These are:

- Heat generation system or boiler,
- Heat distribution system,
- Heat emission system,
- Regulation for coordination of three system listed above according to occupants' needs.

Optimising the heating installation will also take into account provision of sanitary hot water (relatively small in the case of school buildings) and installation of ventilation.

There remains the question of financial cost. With regard to this, it is important to take a medium or long-term view. It is clear that currently, a traditional heating system using natural gas or electricity requires little investment at the outset compared to renewable energy installations. But in the medium to long term, the cost of fossil fuels can only increase and one cannot now confidently predict the extent of that increase (twice, five times or 10 times the current price?). A heating system based on renewable energy will require a greater investment at the outset, but will then give the advantage of sustainable provision for known and fixed costs.



2.2.1. Preliminary remarks

→ Type of heating installation

There are several types of heating installation for school buildings: gas-, oil- or wood-fired systems, with heat distribution by a network of hot water pipes; electric, direct or storage systems and heat pump systems.

Systems can be centralised or decentralised according to the size and volume of the school, the number of buildings and their on-site layout.

In this chapter, we shall mainly elaborate on how to optimise a centralised heating system using a hot water distribution network. Point 4 of this chapter deals with heating using a heat pump.

→ What does optimisation mean?

Optimising a system means rendering it efficient, with low energy consumption, low pollution and easy to use or to regulate. An existing heating system cannot be optimised without having previously improved the energy performance of the building envelope, i.e. better insulation of facades, roof and floor slab, improved airtightness for all external walls and elimination of thermal bridging.

SUSTAINABLE REFURBISHMENT OF SCHOOL BUILDINGS

2. SERVICES AND ENERGY EFFICIENCY



In the context of sustainable refurbishment of school buildings, the heating system must be reviewed and improved in the light of several factors:

Occupants' heating needs

The school refurbishment project may, on the one hand, have entailed a new layout of the premises and/or modified their function and, on the other hand, have greatly improved the energy performance of the buildings' envelopes. In both cases, there will have been a noticeable reduction in heating demand as compared to the pre-existing situation.

In the case of buildings that have been renovated and rendered efficient or very efficient, the heating demand is low and varies considerably according to solar and internal gain. The existing heating system will, thus, be over-dimensioned in relation to the new demands.

Management of time-based variability of requirements

School buildings exhibit considerable variability in heating needs. In winter, school buildings are heated between the hours of 7.30 a.m. and 4.30 p.m. Usually, the heating is off during the evening and night, as well as during weekends and school holidays.

School buildings also involve different types of premises, each having its own characteristics with regard to occupation and heating requirements. While classroom premises are mainly heated from 7.30 a.m. to 4.30 p.m., other premises are only heated intermittently according to when they are occupied.

This variability in demand must, therefore, be integrated into optimisation of the heating system.

General and particular condition of the heating system

Most school building heating installations are old and obsolete. Before optimising the installation, it is important to evaluate the general state of the system and, in particular, the heat generation system, pipework and any regulatory system.

The type of fuel used

In central Europe, most schools have gas- or oil-fired heating. Many schools built during the 1960s also have forced warm air heating systems. Before optimising the installation, one must, therefore, question the applicability of the current delivery system and alternative possibilities.

→ Participation of pupils and teachers in school heating management

Participation of pupils and teachers in maintenance of their school's energy efficiency is essential. Such participation requires raising awareness about certain actions to be taken and certain behaviour to be adopted. These actions and behaviours will have even more impact when the buildings are inefficient:

E.g. one could:

- Lower the classroom temperature by 1° C to 2° C;
- Limit the temperature of certain premises, such as corridors, sanitary facilities, sports halls etc.;
- Turn off the heating system at night time, weekends and during school holidays;
- If possible, use the inertia of the building to advance the end-of-day cut-off
- Close doors leading to the outside or to premises heated to a lower temperature (corridor, unheated premises etc.);
- Install door closers to doors that are frequently used;
- Not cover radiators;
- Regularly purge radiators.

Other, more concrete steps may be taken when optimising the building services. These steps do not require major investment and can be implemented during special event days with the various people involved in the school, particularly pupils and their parents:

- Install insulating or reflective panels behind radiators;
- Insulate pipework;
- Install thermostatic valves.

These behavioural changes and minor improvements will not entail any difficulty, loss of comfort or major investment, yet they will have a real impact on energy consumption. These steps also have the advantage of raising the awareness of pupils, teachers and parents about more rational energy use through changing behaviour.

2.2.2. Assessing the condition and efficiency of the heating system

Before making a choice of whether to retain, optimise or replace the heating installation, there is a case for servicing it and then assessing the condition and quality of the system and its various components: generation, distribution and regulation.

SUSTAINABLE REFURBISHMENT OF SCHOOL BUILDINGS

2. SERVICES AND ENERGY EFFICIENCY



Pupils working on the energy performance of their school with the facilitator « Ecole - Energie » - Wallonia Region, Belgium - Pictures : Sylvie Rouche

2.2.2.1. Heat generation

After the system has been serviced, its performance should be checked. If efficiency is less than 88% (an old system), or 91% (a newer system), partial improvement may be considered. However, one should be aware that this will often simply be a wasted effort. This is why it is often more useful to consider complete replacement of the boiler. However, when refurbishing school buildings, if investment has already been committed to energy-saving renovation of the building envelope, it is possible that other energy-saving investment cannot be considered in the short term. These partial improvements in the heating generation system can also be carried out, at little cost, while awaiting eventual replacement:

→ Improving burner regulation

Excess air improves combustion efficiency. While regulating the burner and measuring performance, optimum efficiency is achieved by increasing excess air to the maximum before the incidence of unburned fuel.

→ Improving the exhaust system

Installation or adjustment of a draught regulator improves combustion efficiency and prevents exhaust water vapour condensing too fast in the chimney, by obtaining the optimum exhaust gas speed.

→ Adjusting the burner setting

One often finds efficient burners (old or new), which are not really used to full advantage: motorised air choke valves that are not closed when the boiler is stopped, as well as a lack of cascade regulation of dual-speed burners.

In the first instance, the automated control of the motorised valve (if any) must be checked, in order to reduce sweeping when stopped. In the second instance, cascade adjustment with regard to control of two aquastats set to different temperatures (on the boiler's flow or return) prevents the burner constantly working at full power.

→ Improving cascade regulation of boilers

Cascade regulation of boilers connected in parallel allows better control of:

- Heat loss when stopped, through hydraulic isolation of boilers whose heating power is not needed at certain times in the heating season.
- Burner operating time (limiting heat loss and pollutants), due to improved adaptation of heating power to outdoor temperature.

This improvement enables considerable savings.

SUSTAINABLE REFURBISHMENT OF SCHOOL BUILDINGS

2. SERVICES AND ENERGY EFFICIENCY



→ Reducing burner power

If the boiler is over-specified (which is often the case with old systems or after works to the building envelope), it is useful to review the burner specifications in order to reduce heating power (except for atmospheric gas burners). This power reduction is performed by changing the nozzle specification for oil-fired boilers, and by reducing gas pressure for gas boilers. Nonetheless, this reduction is limited to 60% – 80% of nominal power, according to model.

→ Reducing boiler operating temperature

Working on the boiler setting according to outdoor temperature (modulating temperature) reduces heat loss when stopped but this can prove tricky. Advice must be sought from the manufacturer before carrying this out, in order to avoid discomfort arising from disturbance to particular hydraulic circuits and to avoid condensation causing internal corrosion.

→ Sealing and re-insulating the boiler

Searching for and sealing nuisance leaks reduces off-cycle heat loss and improves combustion efficiency by reducing excess air. Similarly, jacket insulation reduces heat loss.

2.2.2.2. Heat distribution and emission

A check should be made of the general condition of the distribution network (pipework, valves etc.) and, more particularly, vulnerable components such as joints, elbows etc. A check should also be made of the condition of heating units in each classroom.

2.2.3. Replacing the heat generation system

In the event that the heat generation system is obsolete, in poor condition or has an efficiency of less than 88%, there is a case for replacing it.

Boiler replacement should be considered in the context of an inspection that takes into account all components of the system (generation, distribution, emission and regulation), as well as energy efficiency improvements to building envelopes, internal gains linked to occupation etc.

Given the size of the financial investment, it is important to ask oneself various questions, in particular about the choice of fuel, the possible option of condensation and optimising regulation. This is also the time to analyse the condition of the distribution circuit, in order to avoid grafting a new branch onto a dead tree.

Heat generation systems are categorised by their efficiency and their energy source. Energy sources are either non-renewable fossil (oil, gas or coal), or renewable (biomass, solar, hydraulic or wind).

When replacing a boiler and according to the available budget, the use of renewable energy vectors is encouraged as far as possible. The choice of vector is also made according to the school's location (urban, suburban, countryside etc.) and according to whether there is a heating network, as well as local availability of resources.

During boiler replacement, three fuels are generally weighed against each other: wood, in the form of chips or pellets, oil and natural gas. Different arguments can incline the decision maker towards one or other of these solutions.

→ Energy efficiency

If boilers were to be classified according to their energy efficiency, the following order would obtain:

- gas condensation boilers,
- oil-fired condensation boilers,
- traditional, forced-draught burner gas or oil boilers, modulating pre-mix burner gas-fired boilers and wood-energy boilers,
- atmospheric gas boilers.

Gas condensation boiler technology enables standard efficiencies of 110% NCV. If one considers that the current standard efficiency of low-temperature boilers, whether oil-, gas- or wood-fired, varies between 93% and 96%, the gain achieved by opting for gas condensation boilers is about 15%, which is a not inconsiderable saving. Fuel oil condensation boilers allow achievement of 104% NCV efficiency.

→ Production of CO₂ and polluting emissions

For the end user and given a similar level of technology, combustion of gas produces 25% less CO₂ than combustion of fuel oil (for an equivalent energy consumption). This argument alone is sufficient to recommend the use of gas rather than

SUSTAINABLE REFURBISHMENT OF SCHOOL BUILDINGS

2. SERVICES AND ENERGY EFFICIENCY



fuel oil in the context of a policy for reducing greenhouse gas emissions. As for wood, its combustion has a neutral impact on CO₂ emission. This can be seen by considering the carbon cycle. Nonetheless, this argument is only true if the forest from which the wood is taken is sustainably managed. If this is so, the huge potential of wood for reducing CO₂ emissions is apparent. Even when one considers the entire production cycle of wood, i.e. its felling, packing and transport as well as combustion, it is seen that CO₂ emissions are clearly lower than those of other energy vectors for a similar energy output. Gas is the least polluting fuel at the point of use, with the lowest CO₂, SO₂, soot and NO_x emissions. According to the type of emission one is concerned with, fuel oil and wood are more or less polluting. In terms of NO_x emissions, the two energy vectors are equivalent. In fact, wood emits less SO₂ but more fine particles (dust).

→ Fuel cost

In the past, the oil was, on average, cheaper than the gas allowing significant savings. Today, it is difficult to clearly determine on this point. Wood is cheaper than gas and oil, thereby allowing savings and amortize larger investments. Wood pellets have a price that tends to align the oil, while remaining substantially cheaper.

→ Financial investment

The cost of oil and gas boilers is similar, whatever the system chosen. The cost difference is, in any case, minimal compared with the overall installation cost. Boilers using condensation technology are more expensive than traditional boilers, but their extra cost is compensated by the resulting energy savings.

Wood-burning systems are significantly more expensive than similar gas or fuel oil systems. This difference is mainly due to the price of the boiler on the one hand, and to the installation cost of storage and transport. In certain cases, it is even necessary to construct a new building for fuel storage. To conclude, the investment required for a wood-burning system depends very much upon the context, but, in general, it can be said that it is of a higher level than that required for gas or fuel oil systems.

Other considerations, such as storage volume, system monitoring and control, and fuel needs for other purposes (e.g. kitchens) can also affect the choice.

2.2.4. Optimising the heat distribution system

Improving the distribution network must enable restriction of heat loss between generation and the heating unit and restriction of electricity consumption by circulators. To achieve this, it is recommended that the length of pipework should be limited and that it should be insulated. Also, a variable speed circulator should be chosen, allowing the system to shut off when there is no heating demand.

→ Insulating pipework and valves

Insulating pipework and valves is an obvious, even a mandatory solution, as it enables an 80% to 90% reduction in heat loss. This means that the investment will always be quickly repaid by energy-savings.

Insulating valves is also very cost efficient. However, this is rarely undertaken and often encounters scepticism from technical managers. They argue that insulation temporarily hides the appearance of leaks and, therefore, there is a risk of greater damage being incurred. This reasoning should, however, be seen in context:

- Every valve that is not visibly fragile should be insulated using easily removable shells or wadding. Regular monitoring can also easily be carried out.
- Obviously, a valve that already presents watertightness defects should not be insulated, but in any case, such valves should automatically be replaced as any leak and top up with water is a source of internal corrosion to the system

→ Balancing distribution

Poor flow rate in a heating system circuit is a sign that pressure loss between circuits is not balanced. This lack of balance can lead to indirect overconsumption through raising the heating curve. Thus, increasing flow rates or any other sort of regulation is a bad solution. In the first instance, installing thermostatic valves on the heating units already improves the situation. Ideally, differential balancing valves should be installed at the bottom of risers and correctly adjusted. It is recommended that either specialists be employed, or that the technician should have substantial experience of balancing systems, as it is far from easy and is quite time-consuming.

→ Reducing circulator flow rates

The reduction of circulation flow rates leads to reduction of electricity consumption and, sometimes, mitigation of comfort

SUSTAINABLE REFURBISHMENT OF SCHOOL BUILDINGS

2. SERVICES AND ENERGY EFFICIENCY



Insulation of pipework and valves - Pictures : Sylvie Rouche

and hydraulic problems. In the first instance, cutting off circulators in the warm season, or when the outdoor temperature reaches a certain level (e.g. 15° C), is a good start. Other action is possible, e.g.

- Replacement of an old, over-dimensioned circulator by a multispeed circulator, with its speed governed by the outdoor temperature, gives a payback time of about five years.
- Replacement of that circulator by a variable speed one will give an even better improvement, as compared with a three-speed circulator. Payback time for this is also estimated as five years.

2.2.5. Optimising emission or heating units

In many schools, radiators are installed against uninsulated external walls and/or glazed breast walls. This gives rise to major heat loss (approximately 39 litres of fuel per square metre of 24 cm brick wall). Radiators are usually covered.

→ Insulating breast walls behind heating units

If the school building refurbishment will not involve complete insulation of external walls, it is worth insulating the wall behind the heating unit. By way of example, simple 0.5 cm thick, aluminium-covered insulation can pay for itself in less than a year. In the case of glazed breast walls, it is worth replacing these breast walls by solid, insulated walls, but this involves more substantial works and investment and often needs planning permission.

If there is sufficient space between the radiator and the outside wall (a 3 cm gap must be left between the radiator and the wall), it is recommended that a 2 cm thick insulation sheet, covered with an aluminium sheet, be glued to the inside surface.

→ Clear the space around the heating unit

Everything surrounding a heating unit (shelves, decorative alcoves, books, notebooks, files or clothing placed on top of radiators or curtains covering the heating unit) hinder heat emission. Such encumbrances do not themselves entail additional consumption, but risk causing discomfort. If that discomfort caused managers to increase the water temperature of the system and possibly overheat some areas of the building, this would clearly run counter to energy efficiency.

Thus, it is always a good idea to remove all encumbrances from the heating units. A radiator's emission will hardly be

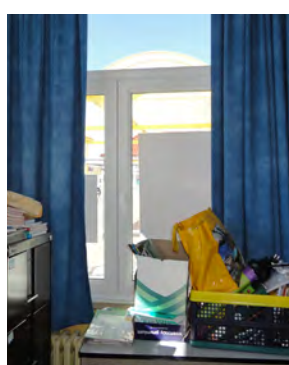

Pictures : Sylvie Rouche

SUSTAINABLE REFURBISHMENT OF SCHOOL BUILDINGS

2. SERVICES AND ENERGY EFFICIENCY



changed if the alcove dimensions shown below are observed.

→ Balancing the system

A heating system must be correctly balanced, i.e. so that the various heating units are provided with their nominal flow rate. If this is not the case, there is a risk of comfort problems in the premises at the end of the circuit, which might be

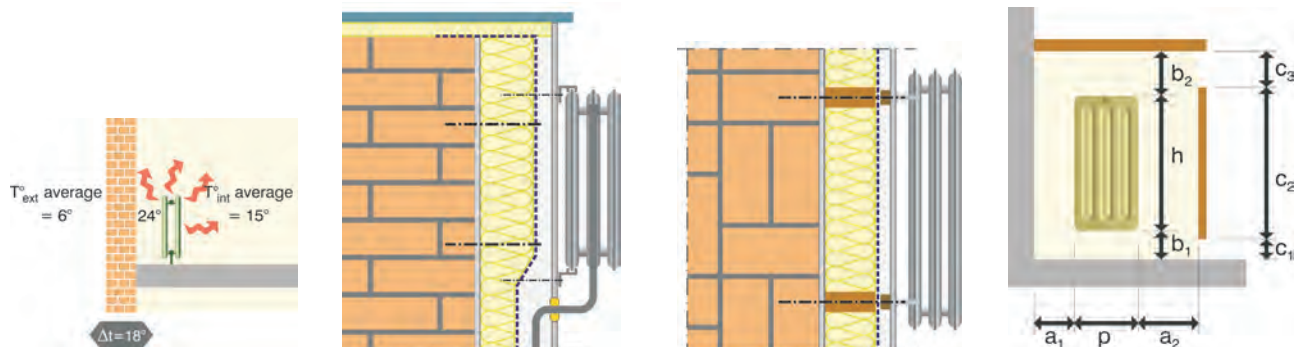

compensated for by increasing the settings, thus causing excess energy consumption.

2.2.6. Designing the heating regulation system

This part of the chapter was drafted on the basis of the experience of the facilitator «Energie / Ecole» in the Wallonia Region.

Preliminary note: the importance of easy-to-use regulation

Regulatory systems are becoming more sophisticated: all sorts of things are becoming possible, but paradoxically, regulatory equipment is becoming more and more difficult for the ordinary user to understand and use.

Yet, if the user and/or technical manager does not understand or is not familiar with the operation of equipment and systems used in the building, even the best regulatory system can lead to disaster in terms of energy consumption.

This is why the designer, when refurbishing school buildings, will install regulating equipment according to the knowledge and competence of the occupant and/or manager. Technology should serve the occupant and not the other way round.

2.2.6.1. General information

The regulatory system can be improved by the following measures:

→ Installing regulation to an unregulated heating system

Too many old systems are unregulated with the boiler water temperature or the position of mixer valves being adjusted manually according to the season. There is no regulation of ambient temperature other than by opening windows. Obviously, this is unacceptable. If the system is unregulated, ideally a complete regulatory system should be designed as though for a new system. However, attention should be paid to the type of boiler or boilers installed. If the system does include regulation, this can also be renovated: replacement of valve motors, regulators, sensors etc.

→ Improving the night time decrease

Various night-time regulations can be considered; i.e. during off-peak hours:

- Decrease by lowering temperature (often observed, but not very effective);
- Heating system cut-off, by combination of a timer and an ambient temperature thermostat;
- Heating cut-off with optimised restart, by combining an optimiser with the actual ambient temperature thermostat.

With loss reduction in the range of 10% – 37%, these improvements are cost-effective.

→ Improving heating curve regulation

Heating curve regulation is necessary if comfort is not generally achieved in the building (insufficient temperature causes

SUSTAINABLE REFURBISHMENT OF SCHOOL BUILDINGS

2. SERVICES AND ENERGY EFFICIENCY



discomfort, excessive temperature causes both discomfort and overconsumption).

The heating curve is individual to each building and depends on the specifications of the heating units, the desired indoor temperature and the building's thermal characteristics. If one of these parameters changes (as will occur during refurbishment), regulation of the heating curve must be reassessed.

→ Install thermostatic valves.

Thermostatic valves allow restriction of a heating unit's output in premises where heating inputs (sunlight, high occupancy levels, IT equipment, lighting etc.) are greater than elsewhere, variable and lead to local overheating problems.

There is a very broad range of valves: from the simplest to the most sophisticated. They should be selected according to occupant awareness of good management.

→ Regulating the system by homogenous zones

It is important to understand the building to be regulated by assessing zones receiving external gains (e.g. north and south facades) or with differing occupancy profiles (e.g. areas occupied outside normal hours).

As far as possible, these different areas should be grouped into homogenous zones, enabling the provision of more suitable regulation.



Pictures : Sylvie Rouche

2.2.6.2. More precisely ...

We start from the assumption that the existing system is unregulated and that the heat generation system is to be replaced. Installation of suitable regulation to an unregulated system (i.e. without night-time decrease and without accurate indoor temperature control) enables 30% savings on the annual fuel bill.

Starting with a traditional system, shown graphically below, several steps can be taken – in order of priority:

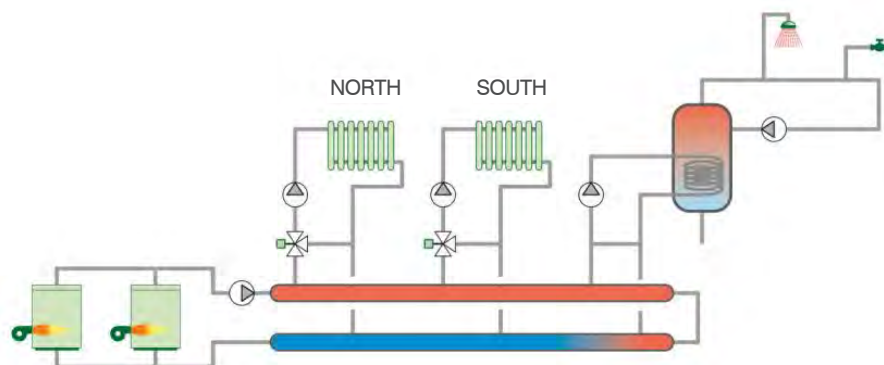

→ Replacement of existing boilers by a single boiler

With increased overall technical reliability of boilers, the risk of breakdown is very small. Furthermore, increased insulation of school buildings enables an adequate temperature to be retained for the 24 hours a heating engineer may take, if required.

Since the output of a boiler is improved at low load, there is an energy-saving benefit in only installing a single boiler:

SUSTAINABLE REFURBISHMENT OF SCHOOL BUILDINGS

2. SERVICES AND ENERGY EFFICIENCY



- Where the energy source is gas, a modulating burner would be chosen;
- Where the energy source remains fuel oil, a two-speed oil-fired burner would be chosen.

If the current heat generation system is replaced by a single boiler, this removes the need for cascade management.

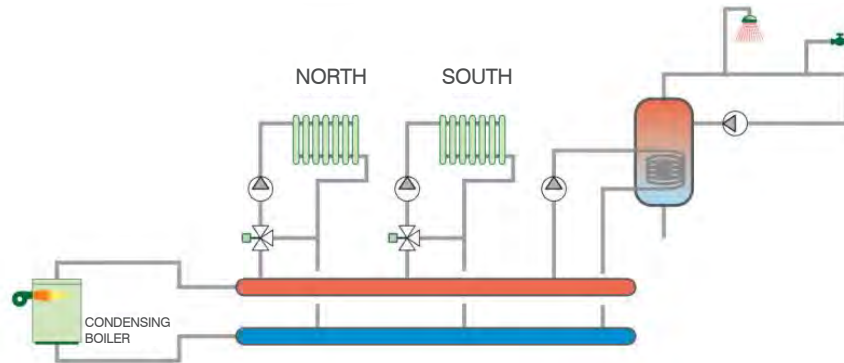

Comment:

Many manufacturers emphasise «complete peace of mind» to encourage installation of a second boiler, but, in reality, the cost of doubling up on boilers is no longer justified except for very high outputs.

An alternative, conservative strategy is to retain one of the old boilers in parallel with the new, but with feed water shut off. If necessary, it might always prove useful.

→ Replacement of existing boilers by a condensing boiler (gas), or a very low temperature boiler (oil)

With an old boiler, cold water let into the boiler in the morning, when the heating system starts up again, damages the boiler: internal condensation, corrosion, mechanical stress between hot flow and cold return etc.

If the existing boiler is replaced by a condensation boiler, the cold water inlet is carefully designed to improve system output (higher condensation).

In this case:

- The primary circuit opens, there is no main pump etc.
- There is no longer any need for temperature regulation of return water at start-up etc.

N.B. the manufacturer must declare the boiler's capacity for operating with zero flow rate. Warning: boilers with an internal protection bypass loop should be avoided.

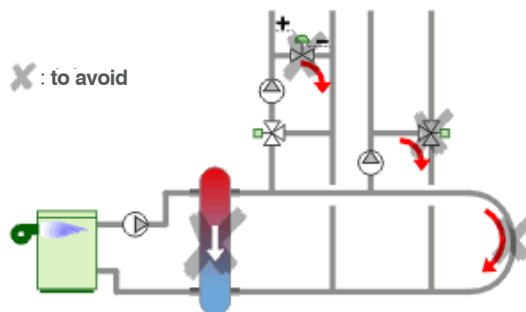

→ Decentralised and instant supply of sanitary hot water – if necessary.

Sanitary hot water supply requirements in a school are varied and sporadic: kitchen, maintenance premises, sports hall showers etc. If the existing boiler has been replaced by a condensing boiler, demand for very hot water to supply a cylinder will disrupt the boiler's proper condensation.

For limited sanitary hot water requirements, with natural gas:

For existing and old systems, production is centred in the boiler room. From the boiler room, a long sanitary hot water loop feeds the various draw-off points.

Nowadays, room-sealed (or fanned fuel) water heaters can simplify the installation:

SUSTAINABLE REFURBISHMENT OF SCHOOL BUILDINGS

2. SERVICES AND ENERGY EFFICIENCY



- Production of sanitary hot water can be decentralised and instant (no more hot water storage);
- No more need for a sanitary hot water loop (or its circulator);
- If there are showers, an instant supply of water at 45° C removes any concern about Legionella.

There is no longer any need to integrate sanitary hot water priority into heating system regulation.

For limited requirements, without natural gas:

Decentralisation using small electric boilers would be envisaged. There is no longer any need to integrate sanitary hot water priority into heating system regulation.

For major sanitary hot water requirements (swimming pool, large communal kitchen etc.):

Installation of a boiler specifically dedicated to production of sanitary hot water and independent of the heating system would be envisaged.

Preference would be given to:

- A double return condensing boiler, allowing for a sanitary hot water connection on the high-temperature return;
- A semi-accumulation system with the lowest possible temperature.

One would also consider the possibility of integrating a solar energy system, while checking its cost effectiveness.

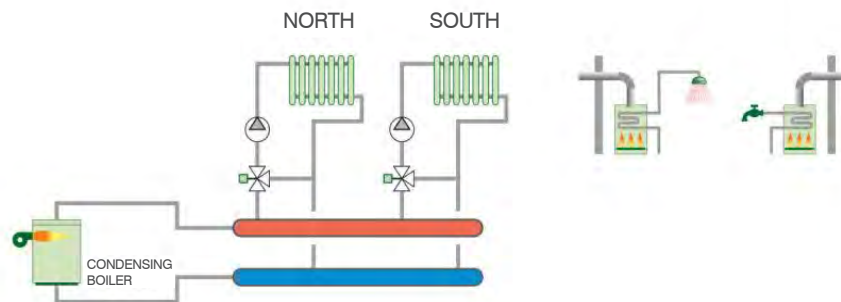

→ Installing thermostatic valves and getting rid of three-way mixer valves

Several observations can be made with regard to school buildings:

- With increased building insulation (new joinery, roof insulation etc.), heating needs are more and more linked to internal (presence or absence of pupils) or external (solar gain) inputs;
- It is very difficult to find a representative local control sample for a zone within a school;
- If production of hot water is independent of the heating system, there will no longer be unwanted temperature increases of the boiler water – sanitary hot water priority – requiring the use of mixer valves etc.

Therefore, an end regulator will be installed to the flow, which will allow room-by-room heat input modulation:

- via a traditional thermostatic valve (primary school, library premises etc.);
- via an institutional thermostatic valve (secondary school, corridor etc.);
- via a motorised valve (canteen, sports hall etc.).

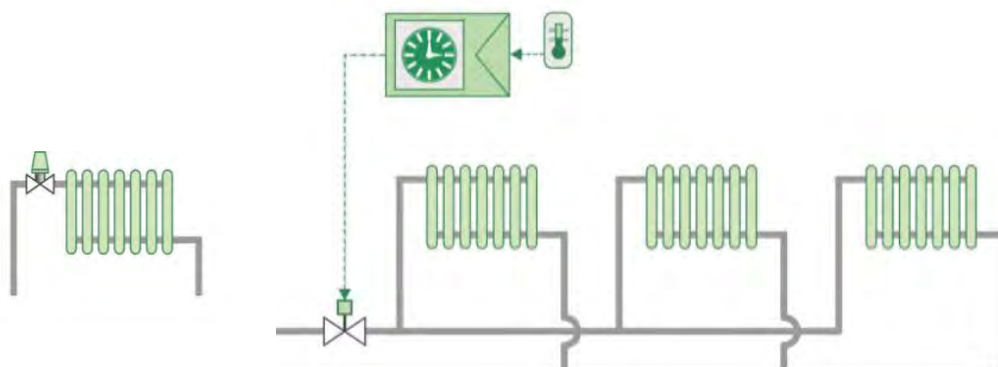

SUSTAINABLE REFURBISHMENT OF SCHOOL BUILDINGS

2. SERVICES AND ENERGY EFFICIENCY



Since the flow of water in the heating units stops when there is no demand for heating (arrival of pupils or of the sun), the need for production of hot water for heating at variable temperature, according to facade orientation, is considerably reduced.

Thus, without any major loss of performance, one can accept boiler water temperature regulation by external sensor and end flow regulation at the radiators.

Climate control regulation of each secondary circuit is no longer justified. There is no longer any need for three-way mixer valves. There just remains the timer-controlled weekly or annual individual programming of each (variable speed) secondary circulator.

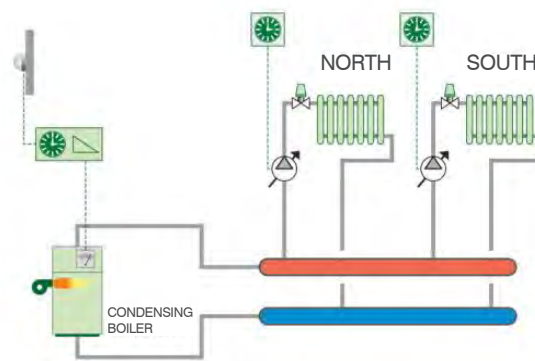

Comment:

the use of three-way valves can be justified where there are different heating units: air heaters, underfloor heating, convectors etc., but, if there is sufficient output, operation of lower temperature air heaters will improve performance (reduced temperature stratification). As for underfloor heating, it is unsuitable for use in schools (impossible to abruptly reduce heating supply when the pupils arrive). If it is already installed, a special mixer valve will limit water temperature to the underfloor heating circuit.

→ Managing frost prevention

In old heating installations, reduced-temperature heating water circulation was maintained at night and weekends to reduce the risk of freezing of facilities.

However, savings are maximised by the complete cut-off of systems. Additionally, total cut-off of the boiler and circulators is ensured after 4 p.m. on weekdays and during weekends, while providing start-up by means of:

- a timer,
- OR
- a two-hour override for evening meetings,
- OR
- a frost-prevention sensor for school holiday periods.

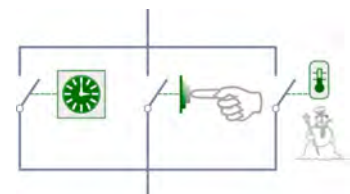

→ Forego restart optimisation

With increased building insulation (new joinery, roof insulation etc.), heating needs are more and more linked to internal (presence or absence of pupils) or external (solar gain) inputs. Heating units are also often over-specified.

So, restarting takes much less time.

Optimisation design (restarting at the last possible moment, according to external temperature and residual ambient temperature), which has in practice always been difficult to implement in school buildings, provides less energy saving since, by the end of the night, the temperature of the premises has dropped less.

If the restart programming, using the circulator timers, has been well thought out, it could be sufficient to achieve the greater part of the gain by:

- an earlier restart on Mondays than on Tuesdays and other days of the week;
- programming the annual timer for two restart schedules: one for winter and the other for summer.

SUSTAINABLE REFURBISHMENT OF SCHOOL BUILDINGS

2. SERVICES AND ENERGY EFFICIENCY



Note that foregoing restart optimisation is debatable in the case of poorly insulated school buildings. In that case, several solutions can be considered:

Solution 1: take advantage of an inbuilt optimisation function in the boiler regulatory system to start the boiler at the optimum time, while retaining a fixed schedule for the circulators;

Solution 2: the circulator control thermostat sometimes includes a simplified optimiser: it starts somewhat earlier when the premises are cold, independently of the outdoor temperature.

Comment:

In all cases, the need for optimisation alone cannot justify installing a regulator covering both boiler and circulators and thus reducing their readability for a layperson. Our experience in the field allows us to confirm that the risk of poor use far outweighs the minor additional advantage offered by optimisation!

→ Simple regulation for an easy-to-use system

Installing an easy-to-use regulatory system in school buildings comprises installing:

- climate control regulation of the boiler: ideally that suggested by the manufacturer;
- independent, instant sanitary hot water heaters;
- a variable-speed programming schedule for the secondary circuit circulators;
- frost prevention sensors and a two-hour override button

Some fine tuning remains to be sorted out according to the project:

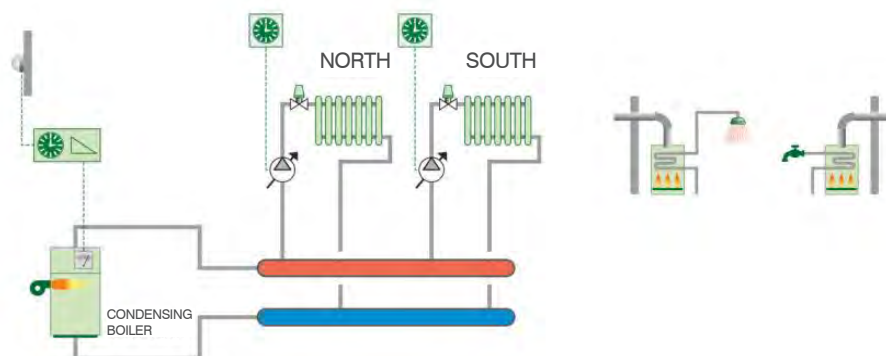

- To make things simpler, the boiler timer may be annual while those of the circulators may be weekly.

E.g.

The principle is that the circulators may operate on a public holiday, while the boiler is off

- The boiler may be regulated in three stages: normal heating curve during the daytime, reduced heating curve during the cleaning period and off for the rest of the time. However, if there is adequate insulation, reduced heating during the cleaning period is no longer necessary given the slow rate of temperature reduction.
- Frost prevention can be simplified if the circulator for each zone starts up when the temperature in its sample premises drops below a given temperature (e.g. 10° C) and if the boiler starts up when the outdoor temperature falls below a given temperature (e.g. -2° C).
- Should management of the override be carried out zone by zone or for the whole school? If it is zone by zone, the override switch will start-up the circulator for the zone as well as the boiler. If it is for the whole school, a switch could be made available on the boiler regulation panel to start up all the circulators.

For each option, the goal should be ease of use.

→ Choosing a regulator

Digital regulation, which is often proposed nowadays, gives an extraordinary range of options, including remote control from home, over the Internet. It remains to be seen whether a headteacher really wants to control the school's heating system on a Sunday afternoon!

SUSTAINABLE REFURBISHMENT OF SCHOOL BUILDINGS

2. SERVICES AND ENERGY EFFICIENCY



This technology, however, has three major drawbacks:

- It is almost incomprehensible for an outside layperson (the black box effect);
- High cost if the school management uses an external maintenance service.

By way of information: in Belgium, a visit by a technician from a company to regulate the system is automatically charged at the rate of €500 (lump sum for two hours plus travel), plus €175 for each additional hour.

- A blurring of responsibility in the event of malfunction: the heating technician refers to the equipment installation and regulating company, while the latter throws the ball back in the event of difficulty and one accuses the other of being at fault.

In day-to-day practice, if there are persistent management problems, the regulatory system will soon be disconnected, in favour of manual operation, i.e. continuous, energy intensive operation!

This is not about wholesale rejection of this technology, but about using it properly and keeping it for systems where its use is justified.

There is no single ideal solution for all systems. There are various solutions, each suited to specific system profiles and particular personal skills. To clarify: the size of the school and the technical competence of managers must guide the choice of regulation.

Three different profiles may be used by way of example:

- The **small or medium-sized school (one or two buildings)** has a boiler room equipped with one or two boilers and with several secondary flows. The person in charge of the system is not very specialised in heating matters, it is the headteacher or the school's general maintenance technician.

GOAL: to offer the simplest possible regulatory system, that can be understood by a layperson, with a detailed instruction sheet showing the procedures to be followed for restarting in September or October, for the day before school holidays etc.

- **A large school, with several buildings**, a number of boiler rooms and numerous secondary circuits. Breakdown intervention generates multiple journeys. A skilled technical team manages the system. It wants to control the system remotely. It also wants to be independent of a particular brand of regulators and free to buy equipment produced by various manufacturers, in order to ensure healthy competition.

GOAL: to have the systems remotely managed by a specialised maintenance company. The cost of this monitoring will be offset by the major reduction in consumption, via a contract setting out the energy performance to be achieved by the maintenance company.

- **The heating system is large and diversified, but there is no specialist technical skill.**

The choice has to be made between two goals:

- Either one approaches Profile 1, simplifying all the systems as far as possible. Regulation is decentralised; equipment is standardised; diagrams are displayed; there is no black box regulator covering all equipment etc. and each outside person working on the system will quickly understand how to work on it.
- Or one approaches Profile 2, with the aim of having the systems managed remotely by a specialised maintenance company.

→ Bringing together the people involved in the project

It is very important to reach agreement before installing a regulating system. It is essential to insist on a meeting between the heating technician, the design engineers and the person responsible for day-to-day regulation. This should produce a written operating specification, which should be demanded before carrying out programming. To prepare this meeting properly, one must be familiar with the pipework layout and, thus of the division of the school into zones, in order to manage the building properly and give the regulatory system designer clearly expressed requirements. A simple A4 diagram, on which the different hydraulic zones are marked with different colour hatching and showing the operation schedules (gym, canteen etc.), is a very practical tool.

2.2.7. Improving upkeep and maintenance

The quality of maintenance can have a major influence on the energy efficiency of a heating system: dirt reduces the heat exchange within boilers, equipment can slip out of adjustment etc.

Good upkeep and maintenance of the heating system also involves the stakeholders in the school, headteacher, teachers

SUSTAINABLE REFURBISHMENT OF SCHOOL BUILDINGS

2. SERVICES AND ENERGY EFFICIENCY



and pupils being aware of the operation of the heating system.

The following measures should be taken:

→ Regular maintenance of the boiler

Boiler servicing is, in many countries, a legal duty. According to the energy source used, servicing is performed every year, every two years or every three years. Servicing boilers involves a number of steps:

- Boiler cleaning,
- Adjustment of combustion (for forced-draught oil- or gas-fired boilers).

→ Regular monitoring of adjustment settings

In the case of school buildings, it is not unusual to find systems operating 24 hours a day because the override was specially used one day and nobody bothered to reset the system to automatic mode. Also one may find boilers working at the wrong time, because the timers have not taken daylight saving time into account. Such matters can lead to major overconsumption.

E.g.

Stopping the heating schedule turning on and off can cause a 10% to 25% increase in consumption.

Therefore, it is important to regularly check the correct adjustment of regulation settings to avoid any discrepancy. Note that this can be flagged up when the school carries out a precise energy audit of its building.

→ Checking the expansion vessel and stopping leaks

Regular addition of make-up water to the heating system entails rapid deterioration of the boiler heat exchanger, pipework etc. by corrosion, pipe blockage and generation of sludge.

In addition, scaling of the boiler reduces heat transfer and increases the incidence of hot spots, with consequent overconsumption.

It is essential to monitor leaks, to check the make-up water (install a meter/ no more than 1 litre/kW installed per year) as well as the condition of the expansion vessel.

→ Checking the water

With a view to the durability of the system, it is also very useful, once a year, to have a specialist laboratory perform an analysis of the heating system water quality: checking the acidity, hardness and conductivity of the water.

SUSTAINABLE REFURBISHMENT OF SCHOOL BUILDINGS

2. SERVICES AND ENERGY EFFICIENCY



2.3. Optimising production of sanitary hot water for the school



School building refurbishment that cares for the environment will seek to optimise the production of sanitary hot water:

- To limit energy and water demands;
- To meet demands with the best possible performance and a minimum environmental impact.

The primary economy with regard to sanitary hot water is to limit its consumption; which means adding saving drinking water to energy-saving. Consumption of sanitary hot water will be reduced, in particular, by the positioning of draw-off points in relation to its production, by leak prevention and by suitable choice of draw-off point equipment.

These various features aimed at limiting drinking water consumption are described in detail in Chapter C «reducing drinking water consumption».

A traditional school does not need much hot water. Only a boarding school, a large kitchen and large sports facilities (if there are showers in the changing rooms) require hot water. It is, therefore, important to consider the refurbishment of the sanitary hot water system in the following ways:

→ Separately from the heating system

Buildings' heating requirements are more and more frequently met by low temperature heating units, with water heated by an efficient gas condensation boiler.

Production of high-temperature sanitary hot water disrupts this development and should, thus, ideally be separate from the heating system. If there is a large requirement for sanitary hot water, the case for providing it using an independent boiler should be studied.

→ Decentralised and close to draw-off points

Such decentralisation is possible for production of sanitary hot water by either a gas or an electric system.

If gas is available and given that the new constraints linked with Legionella (maintenance of high temperature), production of sanitary hot water should be decentralised as far as possible: production close to the draw-off location, with instant room-sealed heaters (still known as fanned flue heaters). One may as well take gas pipes around the building as sanitary hot water pipes.

If requirements are high, or if gas is not available, a semi-instant system would appear to be optimal: an instant heat exchanger to produce hot water on demand, backed up by a small storage cylinder to stabilise water temperature during the first minute of draw off.

In most instances of refurbishment, this also means designing new sanitary hot water systems.

For these various reasons, we will not pursue this theme in this publication. Nonetheless, we suggest a number of reference works:

- **Energie Plus website** (in French): <http://www.energieplus-lesite.be>
- **Construction and energy, architecture and sustainable development**, Manfred Hegger, Matthias Fuchs, Thomas Stark and Martin Zeumer, in the series Atlas de la Construction, Presses Polytechniques et universitaires romandes, Lausanne, 2011
- **Energiezorg in scholen**, Vlaamse overheid, Vlaams Ministerie van Onderwijs en Vorming, Departement Onderwijs en Vorming, which can be downloaded from the website: <http://www.ond.vlaanderen.be/energie/pdf/energiezorg.pdf>
- **Verwarming in scholen**, Vlaamse overheid, Vlaams Ministerie van Onderwijs en Vorming, Departement Onderwijs en Vorming, which can be downloaded from the website: <http://www.ond.vlaanderen.be/energie/pdf/energiezorg.pdf>

SUSTAINABLE REFURBISHMENT OF SCHOOL BUILDINGS

2. SERVICES AND ENERGY EFFICIENCY



Comment:

Annual energy consumption for production of sanitary hot water can be reduced by installation of a solar thermal energy system. This alternative should be investigated – especially for southern European countries – during refurbishment of school buildings with a large requirement for sanitary hot water (large sports facilities, a swimming pool, boarding facilities etc.), as it enables economies in both fossil fuel and emitted CO₂ (from 150 kg to 400 kg of CO₂ per m² of panel).

However, in many instances of school building refurbishment – northern and central Europe – a solar thermal energy system is not cost-effective, because the highest availability of solar energy is during the summer months, when schools are not open.

Preference should be given to solar photovoltaic systems (see point 9).

It is also possible to produce sanitary hot water using a heat pump. There are various possible technologies. «Free» heat can be extracted from an energy source (outdoor air, groundwater etc.) and transferred to the hot water cylinder.

SUSTAINABLE REFURBISHMENT OF SCHOOL BUILDINGS

2. SERVICES AND ENERGY EFFICIENCY



2.4. Heat generation with heat pump



Space heating using a heat pump becomes a worthwhile solution when buildings are refurbished with a view to approaching low-energy or PassivHaus standards.

In fact, in this type of refurbishment, heating needs are much reduced and the temperature of heating hot water can remain low (around 35° C); which is ideally suited to a heat pump, for usefully energy-efficient operation.

However, for refurbishment and working from the principle that installation of a heat pump cannot be justified except for high levels of energy efficiency, the choice of how cooling is to be provided will be determinant with regard to investment cost.

The European market for heat pumps is constantly growing. The leading regions are Sweden (333,000 units in 2000), Germany (63,000 units), Switzerland (61,000 units) and Austria (33,000 units). Heat pumps' market share for new build reached 95% in Sweden. This must certainly have been affected by the dominance of hydroelectric power. Source: Energie plus

2.4.1. Principles

A heat pump works on the principle of taking heat from a cold source, i.e. an outdoor source (ground, outside air, water, groundwater etc.) and raising its temperature before injecting it into a heat source (a building's heating water or air circuit and/or sanitary hot water circuit).

A heat pump is a refrigerant circuit that always comprises four components:

- **Evaporator:** the refrigerant fluid evaporates, taking energy from the cold source (ground, water, outside air etc.);
- **Compressor:** this increases the pressure and temperature of the refrigerant fluid in its gaseous state. This procedure uses electricity.
- **Condenser:** upon contact with the heat source, the refrigerant fluid condenses, transmitting heat to the secondary fluid (air, water or sanitary hot water circuit);
- **Expansion valve:** reduces the pressure of refrigerant fluid in its liquid state.

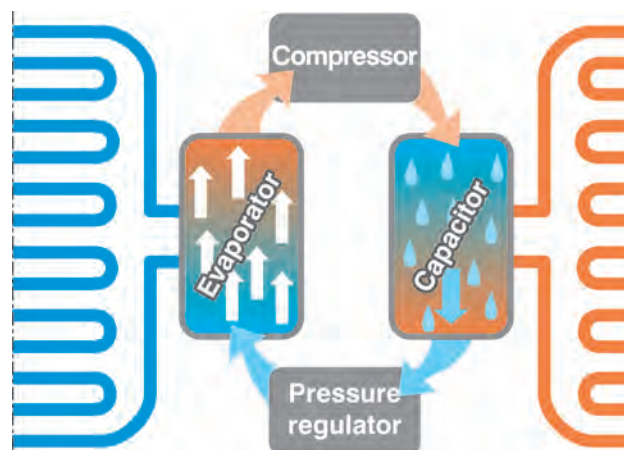

SUSTAINABLE REFURBISHMENT OF SCHOOL BUILDINGS

2. SERVICES AND ENERGY EFFICIENCY



Comment on the refrigerant fluid

Refrigerant fluids are, usually, environmentally harmful. Those that destroy the ozone layer are prohibited (in particular R22) and replaced by fluids such as HFCs. However, these fluids still have powerful greenhouse gas effects.

At the end of its service life, the heat pump must be uninstalled by a specialist who will recover the refrigerant fluid so that it can be recycled or destroyed.

An energy source (electricity or natural gas), is required to operate the heat pump.

Usually, heat pumps use electricity. Electricity generation can be polluting (emission of greenhouse gases from thermal power stations and radioactive waste from nuclear power stations). However, use of electricity by a heat pump is more efficient.

The efficiency of heat pumps is expressed by their coefficient of performance (COP).

The coefficient of the energy performance (COP) is a ratio between the amount of heat produced and electrical power consumed. It reflects the performance of the heat pump in heating mode.

E.g. If a heat pump consumes 1 kWh of electricity and produces 3 kWh of heat, its COP is 3.

The COP of a heat pump varies according to the technology, the renewable source or how the heat is used. The higher the COP, the lower the amount of power required to operate the heat pump in relation to the amount of renewable energy drawn from it on site. The efficiency of the heat pump varies in inverse ratio to the difference in temperature between the cold source and the hot source.

Comment on the coefficient of performance

Tests and manufacturers' information provide this value as measured under specific conditions (ΔT° between the hot source and the cold source). This coefficient takes into account the electricity consumption of the compressor, as well as that of auxiliary equipment (fans, circulators and any supplementary equipment).

However, only the annual COP (COPA) or seasonal performance factor (SPF) enables proper assessment of the actual efficiency of the system and little reliable information is available. The annual performance depends upon weather conditions, the heating demand profile and the installation's specifications.

2.4.2. Various systems

Heat pumps can be divided into various types according to the cold source, hot source and type of operation (fluid circuits).

2.4.2.1. The cold source or heat collector

The temperature of the cold source must be as high as possible. The temperature and the actual power of the cold source (and its stability during the year) will be governed by the geographic location, the available space and its accessibility as well as the type of soil or subsoil.

The various cold sources are:

→ The outdoor air

Air intake from outdoor air, stale air at the exhaust of a ventilation system after the heat exchanger or air from premises outside the thermally-insulated space.

Air source heat pumps recover heat from the surrounding air. They are easily installed and used and can adapt to many different situations. Air is an easily exploitable source of heat and requires no collector to be installed. However, the temperature of outdoor air varies considerably over the year, which results in variation of efficiency of this type of heat pump. In addition, this system is bulkier and generates more noise. This type of cold source is more likely to be considered in an urban environment (slightly higher outdoor temperature and reduced access to ground).

• Intake of outdoor air

The heat pump is installed inside or outside the premises or building and takes heat from the outdoor air. When it is cold, the evaporator may freeze on contact with the outdoor air, which will reduce its efficiency. This type of heat pump that is, therefore, equipped with a regulator which periodically reverses its operation for a brief period, which defrosts the evaporator. This type of heat pump may be reversible and provide cooling to the accommodation in summer.

SUSTAINABLE REFURBISHMENT OF SCHOOL BUILDINGS

2. SERVICES AND ENERGY EFFICIENCY



Outdoor air heat pumps have a lot of disadvantages, e.g. the temperature changes in the opposite direction to that of the heating system; the risk of the evaporator freezing, which occurs for an outdoor temperature of 6°C or 7°C, their noise, bulk etc. Moreover, it is generally necessary to combine them with a boiler (bivalent system)

• Intake of indoor air

This type of heat pump also known as a thermodynamic double flow CMV, allows the combination of double flow mechanical ventilation and a heat pump. It provides the building with both air replacement and preheating of replacement air:

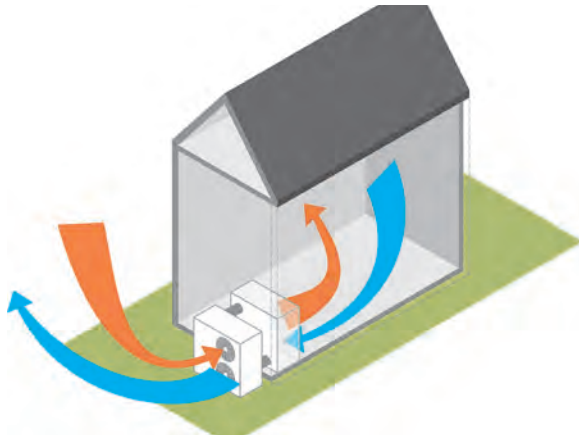

the heat pump recovers heat from the air extracted from wet areas (sanitary facilities, canteen and kitchen) and preheats the fresh air which is circulated to the school premises. This device is reversible

→ The ground outside

Geothermal collection by a horizontal or vertical heat exchanger in the ground (green area, playground, open space around buildings).

• Horizontal ground collectors

Horizontal ground collectors are polythene tubes or copper tubes sleeved in polythene. They are installed as a horizontal loop buried at shallow depth (between 60 cm and 120 cm). At this depth, the heat of the subsoil is largely the result of solar radiation. A glycol solution or refrigerant fluid circulates in these loops in closed circuit (according to the technology used). In order to prevent excessive extraction of heat from the ground and the risks of the ground and the loop freezing, the tubes must be installed with a centre-to-centre gap of at least 40 cm.

• Vertical ground collectors

Vertical ground collectors are made up of two polythene tubes forming a U-shape, installed in a pit and sealed in with cement. Usually, several pits are excavated at least 10 metres apart. Water with added antifreeze circulates in the tubes in a closed circuit. The advantage of this system is the use of a heat source that is stable almost all the year round. Only a small amount of land is used by comparison with horizontal collectors, but excavating a pit requires a certain amount of space and good access. Moreover, survey, design and implementation costs for this type of cold source remain high.

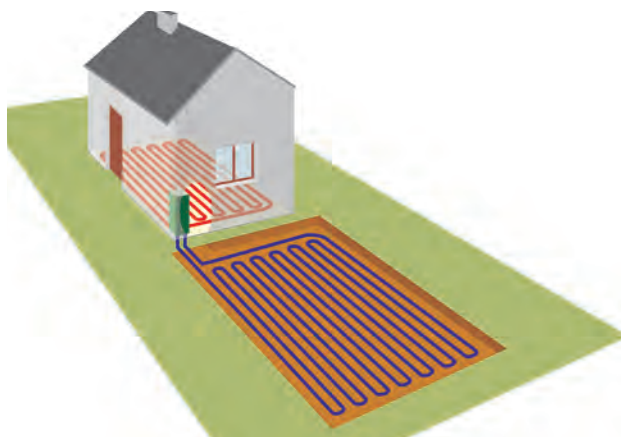

SUSTAINABLE REFURBISHMENT OF SCHOOL BUILDINGS

2. SERVICES AND ENERGY EFFICIENCY

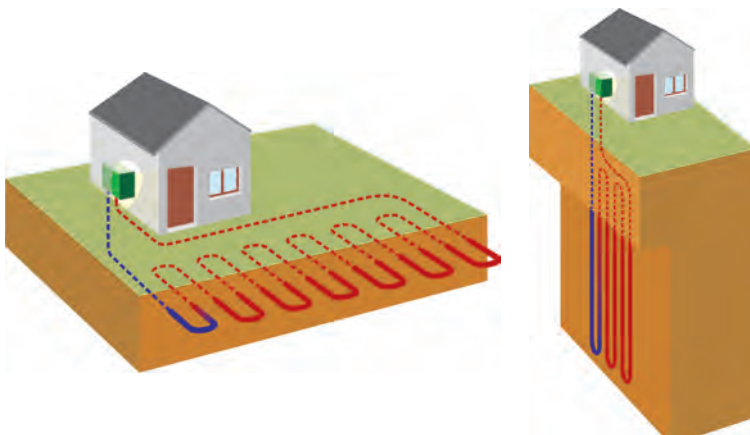

Picture: Architecture et Climat

The disadvantage of this cold source lies in the large land surface required, which is not always available in the case of school buildings in densely built-up urban areas.

Besides this, implementation costs risk increasing steeply given:

- The difficulty of easy access to green areas or playgrounds;
- The need to reinstate the outdoor spaces used.

→ Water

Collection in groundwater (more or less deep) or surface water.

• Vertical collectors in the water table

The water table is a useful cold source, because the water temperature is stable all year round and ideal for achieving good results. However, this system requires one or two boreholes, which must be excavated by professionals and subject to special authorisation. There are two systems: one with a single borehole and the other with two boreholes (see diagrams below). Implementation is expensive and requires a great deal of care to be taken over choice of water table (preferably permeable), water quality, possible flow rates that can be extracted and discharges.

• Vertical collectors in surface water

The use of surface water as a cold source does not give such good results because temperatures fluctuate. There are two possible configurations:

- Direct use, submerging the evaporator in a river bed;
- Indirect use, via a heat exchanger absorbing heat from a filter well sunk close to the river.

Direct heat collection in the riverbed involves the evaporator getting very dirty, relies upon the changeable flow rate of the river and involves expensive implementation and maintenance. As for indirect collection, this reduces the efficiency of the system.

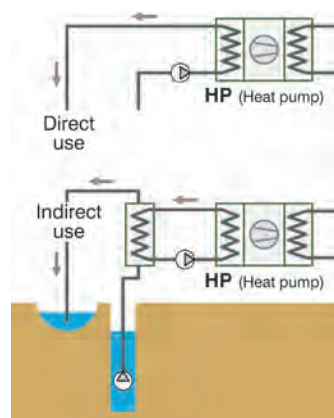
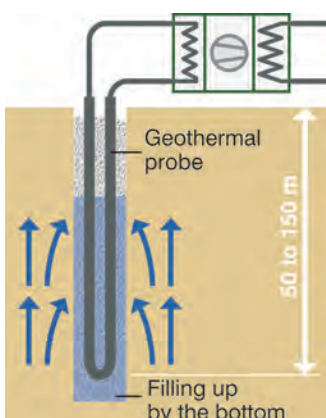

Picture © www.viessmann.be

SUSTAINABLE REFURBISHMENT OF SCHOOL BUILDINGS

2. SERVICES AND ENERGY EFFICIENCY



→ Comparison

The instant energy efficiency of a heat pump can be assessed and is, inter alia, a function of the temperature of the cold source and its stability during the heating season. The following are listed in order of efficiency: thermal discharges, water table, surface water, subsoil heat and outside air.

Cold source	Characteristics	Installation cost.	COP according to Standard EN14511	Installation requirements	Comment
Groundwater	Narrow range of temperature variation (+6°C to +10°C)	HIGH	5 to 6 (W10 to W35)	Need for adequate quantity and quality of groundwater. Local legal restrictions.	Existing wells can reduce costs. Low maintenance cost. Very strict design requirements. More difficult to install for refurbishment.
Surface water	Narrow range of temperature variation	VARIABLE According to the proximity of the cold source	5 to 6 (W10 to W35)	Need for the proximity of water in sufficient quantity. Protection against freezing. Evaporator will be designed according to water quality.	Use of an intermediate water loop in the case of dynamic collectors. Possibility of dirt.
Ground (glycol solution)	Low level of temperature variation (higher for the use of shallow-buried coils). Knowledge of geothermal properties required.	MODERATE TO HIGH	4 to 5 (B0 to W35)	Need for space if a horizontal heat exchanger and antifreeze solution are used.	Vertical or horizontal heat exchangers. Ground and surface conditions influenced design. Low maintenance costs. Very strict design requirements.
Outdoor air	Wide range of temperature variation (0°C to +15°C)	LOW	3 to 4 (A2 to W35)	System that can be used anywhere. Source available in large quantities.	Defrosting and sometimes auxiliary heating are required.

Source: Website Energie Plus - www.energieplus-lesite.be

2.4.2.2. The hot sources or heating units

Hot sources can include the floor, air or water. Heat transfer must occur at the lowest possible temperature (maximum 50°C) for better heat pump efficiency. This transfer may be carried out either by forced air, underfloor or wall heating, fan convective units or radiators. It involves heating units operating at low temperature.

According to the hot source used, several types of installation can be considered.

E.g. if air is chosen as the hot source:

- **Compact indoor installation**

In this case, there are air intake and outlet pipes between the exterior and the evaporator which is located within the building. The heat pump is installed close to an outside wall. Pipe penetrations to the wall are insulated and protected against rain.

- **Compact outdoor installation**

The heat pump is linked to the air circulation network using insulated pipes. This option is expensive because of the transfer of hot or cold sources.

- **Mono-split system**

This system gives great flexibility of installation and allows heating of a single room in the building. One or two indoor units

SUSTAINABLE REFURBISHMENT OF SCHOOL BUILDINGS

2. SERVICES AND ENERGY EFFICIENCY



(in the same room) are linked to a single outdoor air treatment unit. Thus, the evaporator is outdoors and the condenser is indoors, which allows the evaporator to be well supplied with outdoor air. The refrigerant fluid must pass through the wall of the building in insulated pipes and hot air is distributed through ducts of different diameters according to the required flow rates and pressures. The quantity of refrigerant fluid in this system is greater than in the two previous systems.

- **Multi-split system**

Several rooms can be heated using that one or two fan convector units in each of them. There are, thus, several condensers but still a single outdoor evaporator.

For refurbishment, it is not always easy or necessary to replace the whole heating installation and the existing heating units (mainly radiators) are often retained. For refurbishment of school buildings where:

→ **The heating units are traditional radiators**

Reduction in the level of temperature emitted (changing from 80°C – 60°C to 35°C – 45°C) must reduce the strength of emission by about 60%. This is theoretically adequate when the building envelope achieves low energy consumption or PassivHaus efficiency levels.

→ **Installation of mechanical heat recovery ventilation is envisaged**

Installation of an air to air heat pump using extracted air as the cold source and fresh air from outside as the hot source.

2.4.2.3. Types of circuit

With regard to fluid circuits, there are several types of operation:

→ **Operation by direct expansion cooling coil**

The heat pump operates with a single circuit. The refrigerant fluid circulates in a closed loop in the pump, collectors and heating units. This system uses a lot of refrigerant fluid.

→ **Mixed operation**

The heat pump operates with two circuits. The refrigerant fluid passes through the collectors and the heat pump. Energy is then transmitted to a hot water circuit.

→ **Operation with intermediary fluids**

The heat pump operates with three circuits: the heat pump's refrigerant circuit, the collectors' circuit using a glycol or salt solution and the heating units' hot water circuit. The refrigerant fluid passes through the heat pump. It gathers energy upon contact with the loop of glycol or salt solution circulating in the cold source and transmits it to a hot water circuit.

Cold source	Operation by direct expansion cooling coil: 1 circuit	Mixed operation 2 circuits	Operation with intermediary fluids 3 circuits
AIR	air to air heat pump	air to water heat pump	/
GROUND OUTSIDE	Ground to ground heat pump	Ground to water heat pump	Water to glycol solution heat pump Salt solution to water heat pump
WATER	/	/	Water to water heat pump

2.4.2.4. Operating methods

The heat pump may be designed according to one of two operating methods:

→ **Single mode operation**

The heat pump is the only heat generating system. This is the most economic solution with regard to investment. However, when the required output is greatest, the efficiency of this type of heat pump is reduced.

SUSTAINABLE REFURBISHMENT OF SCHOOL BUILDINGS

2. SERVICES AND ENERGY EFFICIENCY



→ Dual mode operation

The heat pump produces most of the heating, but it is linked to another system of heat generation which supplements it. Such a supplement can be a condensation boiler, a direct electrical heating element or solar panels (for supply of sanitary hot water). Dual mode systems can offer alternatives: when it is very cold, the boiler may operate on its own (which requires it to be designed for temperatures of e.g. -10°C) and at a temperature of 3°C to 12°C the heat pump takes over. They can also function in parallel: throughout the heating period, the heat pump provides basic heating and only when it is very cold does the boiler provide the supplementary heating in parallel to it. This last system gives a worthwhile financial and environmental return.

2.4.2.5. Heat pump reversibility

The operation of certain heat pumps can be reversed so as to collect heat from the building or various premises and discharge it to the ground, air or water. This works by reversing the refrigerant fluid cycle with the heat pump drawing heat from various school premises and transferring it to the outside.

This system provides a moderate reduction in temperature, of about 3°C to 4°C in relation to the outdoor temperature. The heat pump can thus be considered to be an air cooling system rather than an air conditioning system. However, installing a reversible system encourages energy consumption all year round for limited benefit in summer, while a heat pump that is only used for heating only consumes power when the weather is cold.

For cooling school premises, a passive cooling system should always be preferred.

2.4.3. Installation in school refurbishment

Installation of a heat pump leads to a series of questions:

→ What type of pump should be used?

The type of pump that can be installed depends both on the efficiency of the building envelope and heating needs, but above all on the location of the school, the type of site and the available surface area around the school buildings.

→ Where should the heat pump be situated?

Generally, the main unit of a heat pump is located within the building to be heated.

• Heat pump installed inside the building

When the heat pump is installed inside the building, especially when this is a school building, the acoustic implications of the location should be taken into account:

- The heat pump must be sited in the premises sufficiently far from the classrooms;
- The heat pump will be placed on anti-vibration pads (if it is noisy) and those pads will be placed on a stable concrete or steel platform. The walls, ceiling and floor of the premises must also mitigate the diffusion of noise nuisance from the heat pump.

If the heat pump impels air in ducts, the air must have a maximum speed of 4 m/s (main circuits). For secondary circuits, the air must have a maximum speed of 3 m/s . These ducts must be made of absorbent materials and the inlet and outlet grilles must be equipped with bird-proof mesh.

If the heat pump uses water, the pipes should be attached to the walls or ceiling by brackets so as to avoid transmitting vibration to the building. Flexible joints and hoses should be used for all heat pump connections.

• Heat pump installed outside the building

It is important to take into account possible noise nuisance to close neighbours, in the knowledge that there is no minimum distance between an external heat pump and neighbouring properties.

In general, a low-noise heat pump should be chosen. If necessary, acoustic screens such as walls or even evergreen trees will be put in place. Care will also be taken not to locate the heat pump in direct contact with outdoor areas used by the children (playgrounds, green areas).

→ What type of operation – direct or indirect?

Direct use of the cold source (surface water, groundwater, exhaust gases etc.) has the great advantage of improving exchange with the heat source and, thus, offering a better coefficient of performance.. However, the following measures should be taken to avoid pollution (leaks of refrigerant fluid), as well as dirt, erosion and corrosion in the evaporator:

SUSTAINABLE REFURBISHMENT OF SCHOOL BUILDINGS

2. SERVICES AND ENERGY EFFICIENCY



- Desilting of the well by a specialist;
- Installation of a filter in the heat pump connection pipe;
- Monitoring maximum and minimum flow speeds to avoid erosion, deposits, frost and damage due to vibration in the evaporator pipework;

Failing this, it is strongly recommended to provide for indirect operation with an intermediary circuit. In addition, it should be assumed that the temperature of the intermediary circuit could fall to 0° C. The correct choice of antifreeze is thus of paramount importance.

→ What type of heating unit?

Heat pumps can only operate properly with a maximum water temperature of 50°C for the heating distribution system. Therefore, a low-temperature, water-or air-based heating system must be chosen. For school building refurbishment existing radiators can be retained.

→ How will it operate?

A heat pump used on its own for space heating (single mode operation) is, naturally, the most economic solution for investment. For higher usable heating power in relation to available power from the cold source, or for operating temperatures of around 50°C, a supplementary heating system should be provided (dual mode operation) e.g. a boiler or electric radiators.

→ What type of refrigerant fluid?

Refrigerant fluids have a not inconsiderable impact on the environment and they should therefore be the subject of an informed choice.

→ What regulation system?

• Power adjustment

For small heat pumps, power adjustment is performed by activation and deactivation. For more powerful units, obtained by combining several small heat pumps, adjustment is performed by switching each pump on or off.

Installations that operate by switching on and off should not be started up too frequently to avoid overloading the public electricity grid and damaging the pump. Note that this is performed using an accumulator (buffer), which can only be omitted in exceptional circumstances.

• Adjustment settings

The regulators control the heat pump according to the heating curve, after obtaining the data from the environment thermostat and the return temperature. The thermostat may be equipped with adjustable recommended comfort and night-time temperature settings.

Different operating controls are possible and have a set order of priority.

Defrosting always has priority and is performed automatically if the outside sensors indicate that it is necessary. This is followed by supply of heating and HWS.

• Adjustment of operating settings

Numerous research studies carried out in Switzerland during the early years of heat pump operation showed that many installations absolutely do not operate as intended by the project designer; this comment also applies to conventional systems. It is, therefore, recommended that results are monitored during the first years of use to check that the system is operating properly.

• Stability of adjustment

Systems available for building services are generally quite slow, which allows for stable and reliable adjustment. Nonetheless, some circuits include parts where the adjusted speed is critical. This applies to the condenser outlet temperature. There are a number of useful recommendations for enabling quick adjustment: site the adjustment valve as close as possible to the heat pump to reduce idle time; choose a quick-closing adjustment valve; optimise valve adjustment settings; use low inertia adjustment thermometers.

2.4.4. Production of sanitary hot water

The heat pump also can be used to produce sanitary hot water. Such a system may be independent or linked to the space heating system. For school buildings, as little hot water is required, preference will be given to a small, decentralised system, close to the draw-off points (small gas or electric boiler).

SUSTAINABLE REFURBISHMENT OF SCHOOL BUILDINGS

2. SERVICES AND ENERGY EFFICIENCY



2.4.5. Advantages and disadvantages of heat pumps

2.4.5.1. Advantages

Heat pumps have the following advantages:

- Technology that does not require fuel storage;
- No need for air intake or exhaust flue;
- Fairly limited discharges (pollution) according to the system's annual COP.

2.4.5.2. Disadvantages

Heat pumps have the following disadvantages:

- To guarantee efficiency of the system and adequate performance, heating units must be large or over-dimensioned. Heat pumps are often recommended for underfloor or wall heating. Those, not very responsive, types of heating unit are suitable when heating demands are very stable. This is not the case for school buildings (high demand for heat in the morning when school starts, then variable demand according to internal gain);
- Geothermal collection: this type of collection requires a large lawn area for horizontal collection. It is difficult to apply this solution to refurbishment of school buildings, unless the school is surrounded by large green areas. Besides this, there are high investment and installation costs for refurbishment, particularly for vertical collector systems;
- Collection from outdoor air: this type of collection is less efficient than geothermal collection; it requires a lot of space outside the building (requiring protection in the case of school buildings) and can also cause major noise nuisance. This system, under certain conditions (reversing the cycle), requires defrosting, which reduces its performance;
- Collection from stale air with mechanical heat recovery ventilation: this type of collection often gives low performance;
- Hydraulic collection: this type of collection may require authorisation and may be prohibited in some regions;
- According to the type of heat pump, its power and the quantity of refrigerant fluid in the circuit, installation of a heat pump may require a planning or environmental permit. Very often, the heat pump only needs to be declared.

SUSTAINABLE REFURBISHMENT OF SCHOOL BUILDINGS

2. SERVICES AND ENERGY EFFICIENCY



2.5. Using solar energy for production of sanitary hot water



Solar thermal heating is a technology that is particularly suitable for providing sanitary hot water.

Solar radiation is a non-polluting, inexhaustible and free energy source, hence the obvious environmental and economic advantage in its use. The solar collectors transform solar radiation into heat using an absorber (a black surface with very high absorption capability and very low emissivity). The absorber transfers heat to a heat transfer fluid (generally a water and glycol mix) that circulates through each collector.

Production of sanitary hot water using a solar thermal energy system will not be dealt with in this publication for the following reasons:

- In most cases, school buildings have relatively little need for hot water. Only school buildings with a kitchen, a boarding facility, large sports facilities (with showers in the changing rooms) or a swimming pool need hot water.
- In many instances of school building refurbishment – northern and central Europe – a solar thermal energy system is not cost-effective, because solar energy is most available during the summer months, when schools are not open.

For school building refurbishment, if financial investment permits, preference should be given to solar photovoltaic systems (see point 9).

The installation of solar thermal panels was the subject of TASK 41 of the IEA SHC Programme «Solar Energy and Architecture» –<http://task41.iea-shc.org>

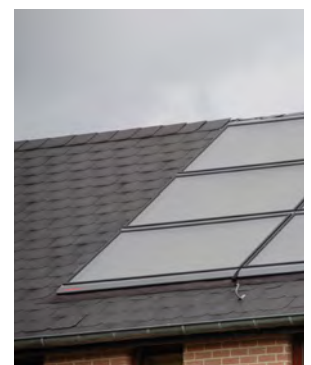
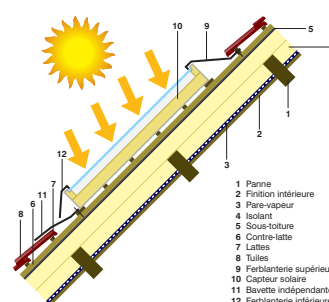
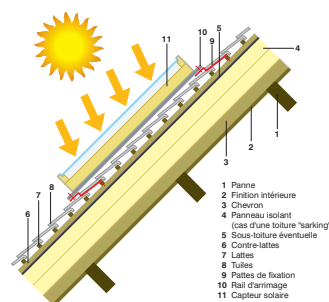
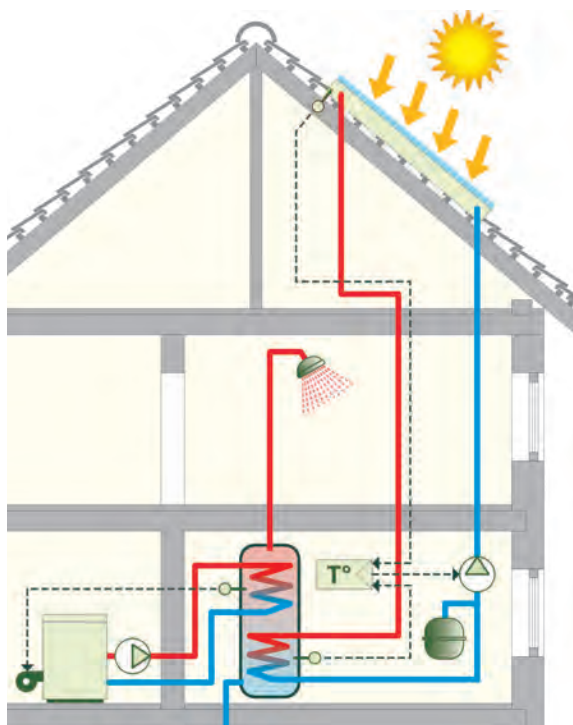

SUSTAINABLE REFURBISHMENT OF SCHOOL BUILDINGS

2. SERVICES AND ENERGY EFFICIENCY



2.6. Optimising artificial lighting for classroom premises



The quality of lighting, whether natural or artificial, is an important factor to take into account when refurbishing school buildings. The quality of lighting to premises goes together with the quality of the learning environment and, thus, the quality of learning. Lighting quality also allows limiting electricity consumption.

School building refurbishment that is concerned about the environment, lighting quality and visual comfort will seek to optimise artificial lighting installations by:

- Limiting the need for artificial light by maximum use and management of natural light (see Chapter A «Comfort and quality of life»);
- Meeting artificial lighting needs with an installation giving the best performance, offering increased visual comfort and having the minimum environmental impact.

For this reason, optimisation of artificial lighting installations must take a series of demands into account:

- Adequate lighting on the work surface, the board and in the room;
- Uniform lighting to the work surface;
- No glare (direct or indirect), reflections or shadows;
- Adequate colour rendering.

These various demands/ideas were presented in Chapter A «Comfort and Quality of Life»

From the financial point of view, artificial lighting is a major element in a school's electricity bill. Without compromising visual comfort, optimising the lighting installation can considerably reduce electricity consumption (by up to 70%). The amount saved on energy bills can then be profitably used within the school for specific forms of learning, for purchase of new equipment or for organising activities or cultural outings.

Renovation of lighting installations in schools was also the subject of TASK 50 of the IEA SHC Programme «Advanced Lighting Solutions for Retrofitting Buildings»– task50.iea-shc.org. This task will provide an update on LED lighting

2.6.1. Basic principles

Before presenting solutions for effective lighting in the classroom premises to be refurbished, it is necessary to give some basic principles about light, lighting, visual comfort, lamps and light fittings.

2.6.1.1. Basic characteristics of visual comfort

These characteristics are described in Chapter 1 «Comfort and Quality of Life» – in point 4.2.2.

2.6.1.2. Lamp characteristics

Each type of lamp has its own properties: luminous flux and efficiency, colour temperature, service life, energy efficiency etc. Some of their characteristics are indicated or given on the lamp itself.

→ Luminous flux and efficiency

The luminous flux of a light source is defined by the quantity of light radiated by a source in all directions. It is expressed in lumen (lm). This could be described as the lighting power emitted by a light source. One can calculate the lighting efficiency from the luminous flux by dividing the luminous flux by the (electrical) power of the source. This is then expressed in units as lm/W.

SUSTAINABLE REFURBISHMENT OF SCHOOL BUILDINGS

2. SERVICES AND ENERGY EFFICIENCY



→ Luminous intensity

The luminous intensity is the luminous flux emitted in a particular direction. It is expressed in candela (cd).

→ Colour temperature

White light can come in many shades: pinkish white, yellowish white or bluish white. One generally associates reddish shades with comfort and warm colours and bluish shades with cool colours. A lamp's colour temperature mainly characterises the colour and lighting ambience provided by the lamp. It is expressed in Kelvin (K). Colours are considered cool when they have a high colour temperature (> 5000 K) and are considered warm when their colour temperature is less than 3300 K.

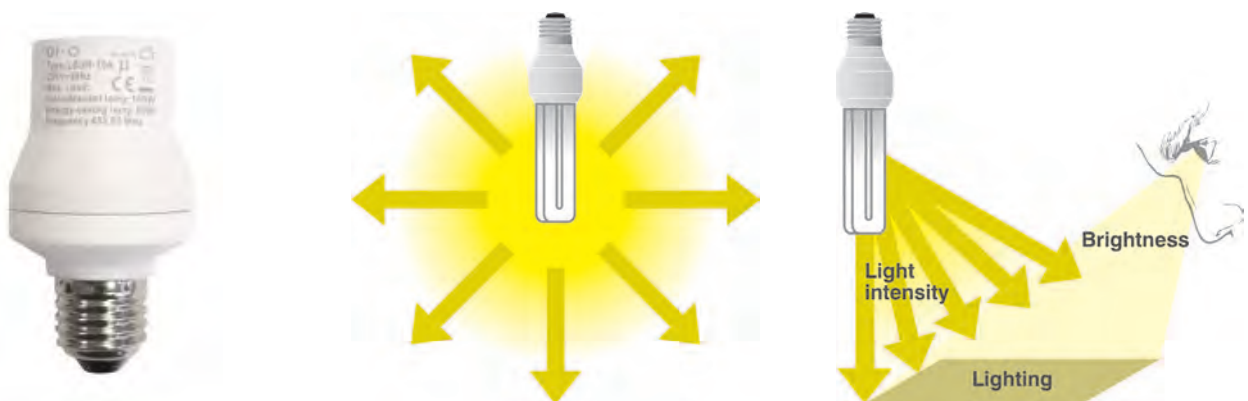

→ The Colour Rendering Index

The Colour Rendering Index (CRI) is the way in which a light source reproduces the various wavelengths of the visible light spectrum, i.e. the precision with which the colours of an object are rendered as compared with its colours under natural sunlight. The Colour Rendering Index has a scale from 0 (poor) to 100 (perfect):

- If the value is greater than 80, this can be considered a reasonable colour rendering;
- If optimum colour rendering is wanted, a value of 90 or above will be chosen.

E.g.:

Daylight has a CRI of 100. An incandescent light bulb (classic and halogen) has a CRI of 100 and a fluorescent lamp has a CRI ranging from 60 to 90.



Colour rendering - Picture: © Verlichting in scholen», Vlaamse overheid

SUSTAINABLE REFURBISHMENT OF SCHOOL BUILDINGS

2. SERVICES AND ENERGY EFFICIENCY



Comment:

For schools, the use of lamps with a CRI higher than 80 and with a colour temperature between 2500 K and 5000 K is preferred. The use of lamps with a CRI higher than 80 allows to get closer to daylight and the use of lamps with a colour temperature between 2500 K and 5000 K allows to work with colors ranging from red to blue: warm light for kindergarten classes, colder or blue light for primary classes (promotes attention and concentration)

→ Service life

There are several definitions of the service life of a lamp. Generally one refers to the average service life of a batch of lamps as the number of hours those lamps would operate before 50% of them became unserviceable. The idea of being unserviceable can differ from one part of the world to another.

In Europe, a lamp is considered unserviceable when it emits no more than 70% (85% for incandescent lamps) of its initial luminous flux. In the United States, a lamp is considered unserviceable when it no longer works.

→ Energy rating for lamps

A lamp's energy rating indicates its energy consumption:

- Classes A and B: Low energy bulbs and fluorescent tubes;
- Classes B and C: Eco (new generation) halogen bulbs;
- Class D: Classic halogen bulbs;
- Class E: Standard incandescent bulbs;
- Classes F and G: Small incandescent lamps and special models.

→ Classroom premises – types of lamps generally used

Most of the time, lamps installed in classrooms are fluorescent tubes.

Light fittings are either suspended or integrated in ceilings.



Picture: Sylvie Rouche



Picture: Sylvie Rouche



Picture: Sylvie Rouche



Picture: Sylvie Rouche

SUSTAINABLE REFURBISHMENT OF SCHOOL BUILDINGS

2. SERVICES AND ENERGY EFFICIENCY



2.6.1.3. Light fitting characteristics

→ Efficiency

A light fitting, by virtue of its function, hinders the diffusion of light because it cannot totally transmit the light produced by the luminous source, part of the luminous radiation is absorbed by its components. The efficiency of a light fitting is the ratio between the luminous flux emitted by the light fitting and the luminous flux of the lamp.

→ Luminous distribution

Mainly, three types of distribution can be adopted:

- **Extensive**, where the light beam from the light fitting is wide, giving a relatively uniform illuminance;
- **Intensive**, with a narrow light beam giving accent illumination;
- **Asymmetric**, which can be used to illuminate vertical surfaces such as walls or blackboards.



Distribution extensive



Distribution intensive



Distribution asymétrique

2.6.1.4. Lighting types or systems

According to the light fittings used and their location, different lighting systems can be distinguished:

→ Direct lighting

Light is emitted directly onto the surface to be illuminated.

This type of lighting is very efficient, therefore the installation will be low-power. Conversely, the risk of glare by using this system is higher and the distribution of light in the room can be quite irregular.

→ Indirect lighting

Indirect lighting comprises the use of a reflective surface (most often the ceiling) to diffuse light in the room. The advantage of this system is the low risk of glare as well as good light distribution in the room. This system is less efficient than a direct system and can even be poor where there are dark surfaces.

→ Combined direct and indirect

For this lighting system, the two previously described systems are combined, thus linking their advantages and their disadvantages. This type of lighting will be mainly used when there are high ceilings, in order to reduce contrast and the feeling of having a high dark or black ceiling.

→ Dual component lighting

For this system, two light fittings are used: the first provides general direct or indirect illuminance, with weak illuminance (approximately 300 lux on the work surface); the second provides a direct light supply to the work surface.

This system is the best for energy-saving: it links a low level of general lighting with localised light fittings, according to need.

Localised lighting can, however, generate contrast and strong shadows as well as unpleasant reflections. Care should, thus be taken to provide good uniformity of light, which allows the damaging effects of contrast to be limited.

Direct lighting is the option usually recommended for classroom premises with a ceiling height of less than 4.5 metres.

SUSTAINABLE REFURBISHMENT OF SCHOOL BUILDINGS

2. SERVICES AND ENERGY EFFICIENCY



The light fittings most often used for this type of lighting are flush light fittings (when there are false ceilings), ceiling-mounted light fittings or even suspended light fittings.

In the case of premises with a greater ceiling height, suspended light fittings are often more appropriate for visual comfort. Care should then be taken not to produce areas of unpleasant shadows, by opting for light fittings with both direct and indirect emission of light. For blackboard lighting, direct but asymmetric illuminance is recommended.



Picture: Coralie Cauwerts



Picture: Coralie Cauwerts

2.6.2. Composition of the lighting system

A lighting system is made up of four main components:

- the luminous source or lamp;
- Auxiliary components;
- the equipment;
- the control.

Each component has an influence on the quality of the installation, on visual comfort and energy consumption. Each type of lamp has a corresponding type of light fitting. Each light fitting contains the auxiliary components required for good operation of the lamp.

2.6.3. The luminous source or the lamp

The luminous source or lamp is the fundamental part of the light fitting. Its role is to provide the necessary light to light a room, an office, a blackboard etc. Luminous sources can be divided into three main categories, according to the means used to furnish the light: incandescent, discharge or light-emitting diodes (LED)

This section presents the various types of lamp that can be installed in school buildings, giving the advantages and disadvantages of each.

2.6.3.1. Types of lamp installed in classrooms

Most of the time, lamps installed in classrooms are fluorescent tubes. Their characteristics are given in the table on next page.



Pictures: website Energie Plus

SUSTAINABLE REFURBISHMENT OF SCHOOL BUILDINGS

2. SERVICES AND ENERGY EFFICIENCY



Type of lamp	Operation	Available power	Efficiency	T° and colour rendering	Service life
Fluorescent tubes T8 tubes; T5 tubes which must be used with electronic ballast; circular tubes	<p>Fluorescent tubes operate on the principle of an electrical discharge occurring in gas to produce light.</p> <p>For its operation, one of these tubes requires ballast and a starter, whose role is to restrict, control and initiate the discharge.</p>	<p>Between 14 W and 58 W. The length of tube varies according to its power.</p> <p>The luminous flux of tubes varies between 1300 lm and 5000 lm.</p>	<p>Very good luminous efficiency.</p> <p>This varies between 60 lm/W and 105 lm/W.</p>	<p>Colour temperature varies according to the powder used in the tube: from warm white (2700 K) to cool white (6700 K).</p> <p>The colour rendering index (CRI) is not perfect, but is nonetheless fairly good (CRI 80 to 95).</p>	<p>The service life of fluorescent tubes depends in part on the type of ballast and the type of starter.</p> <p>It can be as much as 20,000 hours.</p>
Compact fluorescent lamps CFLs	<p>Compact fluorescent lamps are actually folded, miniature fluorescent tubes, whose dimensions have been reduced in order to enable them to be used to replace incandescent lamps.</p>	<p>Very wide range of power:</p> <ul style="list-style-type: none"> - from 3 W to 23 W for those with integrated ballast - from 5 W to over 80 W for those with external ballast. <p>The luminous flux varies from 100 lm to over 6000 lm.</p>	<p>Good luminous efficiency, ranging from 35 lm/W to 80 lm/W.</p> <p>Their energy class is generally A and in certain cases B</p>	<p>The colour can vary between warm white (2700 K) and cool white (6500 K).</p> <p>Their CRI is good, with a range between 80 and 90.</p>	<p>The service life of compact fluorescent lamps with integrated ballast is approximately eight times greater than that of incandescent lamps: from 6000 hours to 10,000 hours.</p>
Light Emitting Diodes LEDs	<p>Light is produced by LEDs according to a third principle. An LED is really a semiconductor comprising an interface between two materials, one of which has an excess of electrons and the other a deficit. When a voltage is applied to the interface, the excess electrons travel to the deficit area and recombine there.</p> <p>This recombination produces radiation the colour of which depends upon the components.</p>	<p>The available ratings of LEDs on the market vary between 0.007 W and 3 W.</p> <p>Their luminous flux varies between 1.5 lm and 200 lm.</p> <p>It must be noted that their luminous flux is very variable according to the ambient temperature.</p>	<p>LEDs available on the market have an efficiency of 20 lm/W to 30 lm/W (white light).</p> <p>Their energy class varies from D to B.</p>	<p>The colour temperature of LEDs varies from warm (2700 K) to cool (6500 K).</p> <p>But their performance is better for cool colours. Their CRI varies between 50 and 80.</p>	<p>The service life of LEDs can be very variable according to the ambient temperature as well as the applied voltage.</p> <p>This can range from 5000 hours to more than 100,000 hours.</p>

2.6.4. Auxiliary components

Certain lamps require the use of auxiliary components in order to operate correctly. The auxiliary components, which are usually integrated into the light fitting, can be divided into two main categories:

- **The starter and ballast** are used for discharge lamps. The two fundamental purposes of this combination are to light up the lamp, as well as to limit current in the tube during its use, in order to prevent it destructing. If the ballast is electrical, the starter is integrated in the ballast

SUSTAINABLE REFURBISHMENT OF SCHOOL BUILDINGS

2. SERVICES AND ENERGY EFFICIENCY



- **The driver** is used for LED lamps.

There are different types of ballast, but these must be chosen according to their suitability for the type and power of lamp with which they operate:

- Electromagnetic ballast,
- Electronic ballast with preheating,
- Electronic ballast without preheating,
- Electronic ballast that can be dimmed or graduated.

→ Ballast for fluorescent lamps

In nearly all cases, a good quality electronic ballast would be selected (minimum class A3¹). Electromagnetic ballast is rarely used in the design of a new or renovated installation.

If the premises benefit from good natural light and if functional management is possible, dimmable electronic ballast produces energy savings of 30% to 50% for the row of light fittings by the windows and 15% to 30% for the next row.

→ Ballast for discharge lamps

For this type of lamp, electronic ballast is most suitable because it increases the lamps' service life (by up to 30%). It eliminates their problem flickering and, so long as both ballast and lamp are dimmable, they allow the provision of natural light to be taken into account (up to 50% of nominal flux).



Comment:

In the context of renovation of the lighting system, the choice would preferably be made of:

- A basic solution: ordinary electronic ballast;
- More sophisticated solutions: dimmable electronic ballast, into which the lighting control can be integrated, which takes account of the use of natural daylight.

→ Driver for an LED lamp

The equipment enabling power supply to an LED is generally called an LED driver. The supply is direct current in the forward direction. Stability of supply to the LED depends upon the quality of the AC/DC rectifier and of the voltage smoothing filter. According to the quality of the latter, fluctuation of the luminous flux (flickering) can cause visual discomfort.

Until recently, the importance of the supply in relation to the LED source was underestimated. However, the main demands in relation to a good supply are strict:

- The service life of the driver must be at least the same as that of the LED;
- The AC/DC conversion performance of the supply must be greater than 85% to guarantee good energy efficiency (expressed in lm/W) of the LED-driver assembly;
- The power factor ($\cos \phi$) must be as close as possible to 1 and the harmonic distortion must be as low as possible so as to reduce loss.
- Emitted electromagnetic interference should be low.

2.6.5. Types of light fitting and their components

A light fitting serves to distribute, filter or transform the light output of lamps. It can be composed of:

- The mounting frame, which enables assembly of the various components of the light fitting (reflectors, louvres, cover plate, diffuser etc.) and the fixing of the light fitting to the ceiling or wall.

SUSTAINABLE REFURBISHMENT OF SCHOOL BUILDINGS

2. SERVICES AND ENERGY EFFICIENCY



- The reflector, which reflects the light emitted by the lamp and directs it to where it is wanted.
- The louvres, which protect the eye from glare, preventing the lamp to be viewed directly.
- The diffuser or guard, which sometimes replaces the louvres and protects the lamp from the environment.
- The cover plate which enables the attachment of electrical auxiliary equipment (ballast, starter etc.).

The light fitting plays a number of roles:

- It serves to best direct the light furnished by the lamp towards the space to be illuminated;
- In some cases, it protects the lamp and any auxiliary equipment from external effects (impacts, water, dust etc.);
- It has an aesthetic role resulting from its form and the manner in which it directs light in the room.

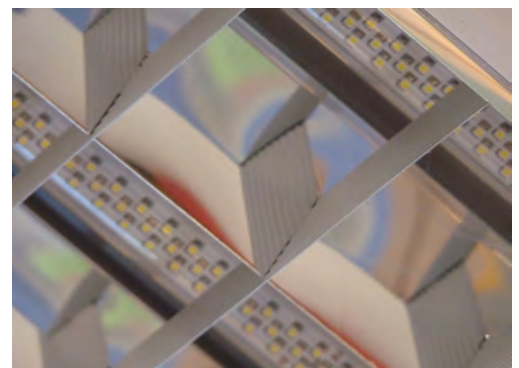

Comment:

In the context of renovation of the lighting system, the preferred choice would be light fittings giving direct illuminance, equipped with a reflector in satin or polished finish aluminium and in which the lamp is hidden or only slightly visible to the observer or occupant.

2.6.6. Types of lighting control or management

A lighting management system will only work if it is completely accepted by the occupants. Occupants can be incredibly imaginative when it comes to overriding an automatic system! Therefore, this must be either unnoticeable or understood and accepted by the occupants. This is even more so for renovation, since there is the memory of the previous situation. It is often advised that the search for economy should not be pressed too far and to the detriment of users' freedom and simplicity of the system. The occupants must be able to switch a light on and off, vary the strength of light emitted by a light fitting, or personalise the environment according to the work being done.

With a control system, a classroom's lighting system can be regulated or managed according to the occupants' needs. This regulation may be at the level of a room, a floor or the whole building.

There are various types of control. The choice will be made according to the type of control wanted and the available budget.

In general, there are four types of control system and these can be linked:

- Lighting control according to available daylight;
- Lighting control according to premises occupancy;
- Lighting control by a programmer/timer;
- Lighting control by zone.

2.6.6.1. Principles of control

→ Switching on and off

Switching on and off is the simplest way of controlling lamps. It is simply a matter of switching lamps on or off (by controlling the electrical circuit) according to need.

In the context of the school building, pupils and teachers must be made aware of energy and environmental requirements:

SUSTAINABLE REFURBISHMENT OF SCHOOL BUILDINGS

2. SERVICES AND ENERGY EFFICIENCY



- not to use the main artificial lighting if there is sufficient natural light;
- to switch the lights off when premises are no longer used.

Such awareness can be promoted by means of small notices placed close to the entrance door of the various premises.

→ Dimming

Dimming is controlling the luminous flux of the lamp according to user needs. This is easily done for incandescent bulbs. It is enough to reduce the current supply to these bulbs to reduce their luminous flux.

For classroom premises, dimming can be useful for rooms that are very deep, or that use projection systems, computer screens or interactive boards. Dimming can also be useful for classrooms in northern Europe, where natural daylight is not always adequate.

In other cases, and mainly for schools located in south and central Europe, natural daylight, if it is well-managed, is easily sufficient during school hours. Therefore, dimming is not necessary.

→ Zoning

A classroom's artificial lighting installation can be divided into zones: the zone near the windows, the blackboard or whiteboard zone, the zone near the corridor.

Zoning is useful insofar as it gives some flexibility of use: part of the room might not be used (as may be the case for a sports hall or canteen), part of the room might receive sufficient natural daylight and not require artificial lighting (in the case of a strongly lit classroom).

Eg.

The diagram above again shows a classroom divided into zones according to daylight. The following zones can be used independently of each other, with three switches close to the entrance door:

- *The row of light fittings the length of the windows;*
- *The row of light fittings near the corridor;*

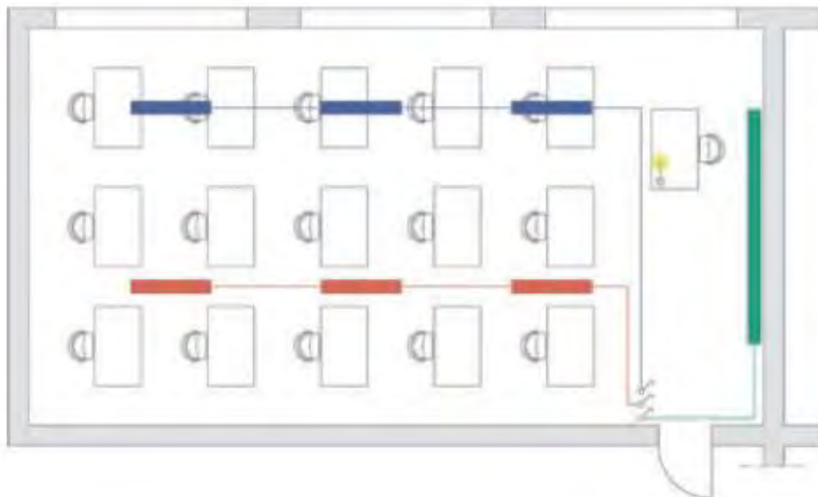

Comment:

For optimum control of energy consumption by a zoned control system, it is important that:

- The stakeholders in the school, teachers and children, should be made aware of and accept this mode of operation;
- The switches should be properly indicated and/or marked.

Ideally, the switch operating the row of lamps near windows should be on the wall facades. So these lamps will be used only when needed.

SUSTAINABLE REFURBISHMENT OF SCHOOL BUILDINGS

2. SERVICES AND ENERGY EFFICIENCY



- The equipment for lighting the backboard.

2.6.6.2. Types of management

→ Management according to natural daylight

In this type of management, the luminous flux of a light fitting is controlled according to available daylight. This type of management is useful for classrooms with large glazed openings. This type of management can be linked to management according to occupancy. Light sensors can be placed in various locations in the room. They will control the lamps either by ON/OFF switching, or by dimming according to the amount of natural daylight.

For school buildings, it is most effective to have the sensor over the work surface. In the case of rooms with large glazed



Picture : Coralie Cauwerts



Pictures: website Energie Plus



Picture: Coralie Cauwerts

openings, it is the luminous flux of the row of light fittings near the windows that will vary according to the amount of daylight.

→ Management according to occupancy or non-occupancy

Presence detection uses a sensor to detect presence (or absence) of a person in the specified space.

There are two main types of detector: PIR (Passive Infrared) and HF (High Frequency). PIR detectors operate by detecting a moving warm body, while the HF technology uses the Doppler effect (differential reflection of waves from a moving body), similarly to sonar detection.

These detectors can operate on the lamps in three ways: switching on, switching off or, more rarely, dimming.

- Presence detection operates completely automatically (switching on when presence is detected and switching off when there is no presence). Presence detection is not recommended for certain types of lamp, in particular for discharge lamps.

- Absence detection requires manual switching on by means of a push button and manages switching off when a person is no longer detected. It is more useful than presence detection in terms of energy saving.

In some cases it is more cost-effective to invest in a presence detector than in renovation of the lighting equipment. This allows the avoidance of major investment and gives immediate, substantial savings.

The use of presence detectors requires some care in premises where occupants' movements are slight, e.g. offices. Low sensitivity detectors risk failing to detect the small amount of movement associated with work on computers or reading.

Presence detection is recommended in premises where people are only present intermittently, e.g. meeting rooms, archive premises or libraries, changing rooms, sanitary facilities or even some corridors etc.

→ Management by time or schedule

Management by time uses a timer to operate the lamps. Changes can be made either at a programmed time, or after the lights have been on for a certain period of time. The action is usually switching off, but can also be switching on or dimming of lamps. This time-based management can also be performed by zone, within the buildings, and/or allow for a minimum level of illuminance.

→ Mixed or combined management

The various types of management presented above can also be combined. It is useful, in the case of a classroom, to combine a system of control by zone with management according to daylight and/or a scheduled management. According to the type of renovation proposed, the system chosen may be:

SUSTAINABLE REFURBISHMENT OF SCHOOL BUILDINGS

2. SERVICES AND ENERGY EFFICIENCY



- Simple: control by zone;
- More complex: control by zone with illuminance management according to natural daylight, or even scheduled management and, for certain premises, management by detection of non-occupancy.

In all cases, care should be taken that energy consumption for the whole control and management system should be as low as possible.

2.6.6.3. Control devices

→ Switch

The switch is the simplest device for control of lighting. It is generally a device to mechanically open or close the electrical circuit and, thus, to supply or cut off the supply to the lamps.

→ Dimmer switch

The dimmer switch is a control device that enables alteration of the luminous flux of the lamps controlled by it. Generally these only work for incandescent lamps (including halogen) or certain compact fluorescent lamps. Fluorescent lamps require a special dimmer, which controls the dimmable electronic ballast.

→ Timer

The timer is a device that is usually located on the electrical panel. It allows lighting to be automatically switched off after a certain time, which can be set by the users. This type of management can be very practical in circulation areas (corridors, stairs etc.) that are only occupied for a short time.

→ Presence /motion detector

There are various types of presence detector: wall-mounted or ceiling-mounted detectors. The advantage of wall-mounted detectors is that, in the context of renovation, it is easy to replace a switch by such a detector. Conversely, as the field of

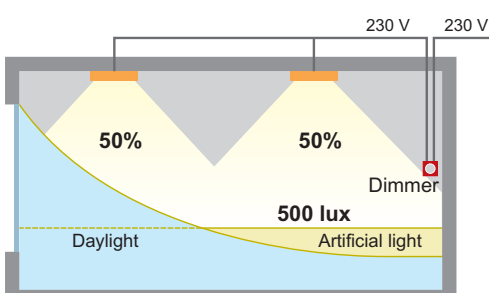
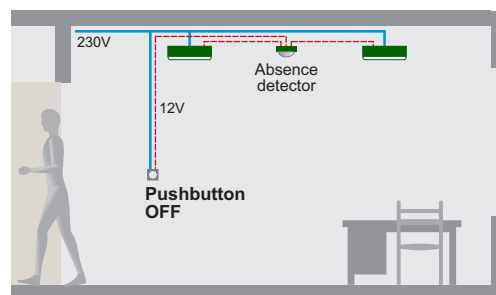
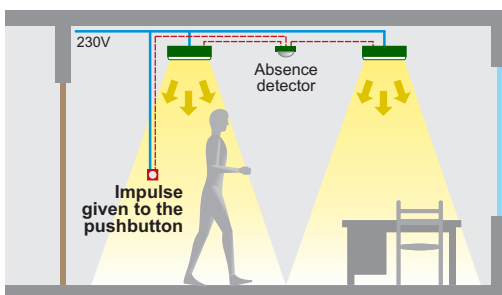
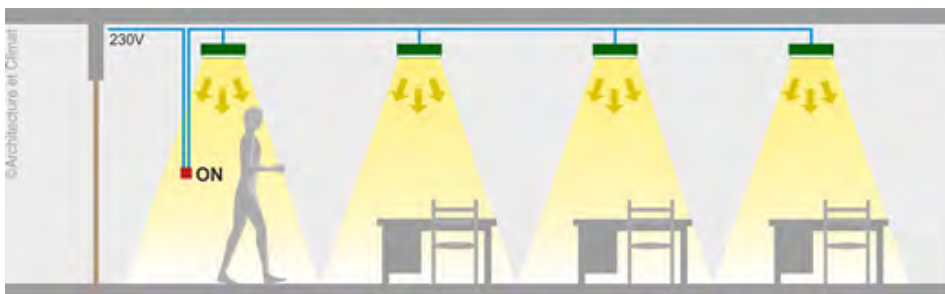

SUSTAINABLE REFURBISHMENT OF SCHOOL BUILDINGS

2. SERVICES AND ENERGY EFFICIENCY





view is limited, their performance is often inferior to that of ceiling-mounted detectors.

2.6.7. Assessment of the existing lighting installation

Before undertaking works to renovate the lighting system, the system must be assessed both from the point of view of visual comfort and that of energy efficiency. This assessment can sometimes be carried out by one of the people involved in the school, if they have adequate knowledge, but it is generally recommended to use a lighting specialist.

2.6.7.1. Assessment of visual comfort in classroom

The table below takes up a series of questions that should be asked in order to assess visual comfort or, at least, to detect any lighting problem.

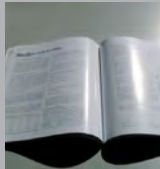
Questions	
<p>Is the illuminance level adequate?</p>	<p>The illuminance level is generally measured using a light meter.</p> <p>The following are the recommendations for classrooms:</p> <ul style="list-style-type: none"> - 300 lux in the classroom area, - 500 lux on the work surface. <p>Ref : European standards EN 12464-1 and EN 15251</p>
<p>Is the luminance uniform?</p>	<p>In the classroom, uniformity should be:</p> <ul style="list-style-type: none"> - > 0.7 on the work surface and blackboard or white board, - > 0.5 in areas adjacent to the work surface and board.
<p>Is there a risk of glare?</p> <div style="display: flex; justify-content: space-around;">    </div>	<p>The risk of glare can be identified on the basis of measurements performed using a luminance measurement device. Care should be taken to identify the following types of glare:</p> <ul style="list-style-type: none"> - Direct, - Reflected (screen, whiteboard etc.), - Veiling glare
<p>Are there unpleasant shadows?</p>	
<p>Is the light a suitable colour?</p>	<p>The colour of the light is an important parameter in the psychological perception of a space. According to the type of space the following values are generally recommended:</p> <ul style="list-style-type: none"> - General classroom: between 2000 K and 5000 K, - Infants classroom: 3000 K - Primary school classroom: 5000 K
<p>Is the colour rendering index suitable?</p>	<p>In general, a CRI greater than 80 is recommended for classrooms</p> <p>In art activity classrooms, a higher CRI of about 90 is recommended.</p>

Comment:

SUBTASK C «Assessment of Technical Solutions and Operational Management» assessed visual comfort associated with existing lighting systems in the SUBTASK A exemplary projects – [see report XXX](#).

SUSTAINABLE REFURBISHMENT OF SCHOOL BUILDINGS

2. SERVICES AND ENERGY EFFICIENCY



2.6.7.2. Energy efficiency assessment of the lighting installation

The table on next page takes up a series of questions that should be asked to assess the energy performance of the existing installation.

<p>Is the power of the installation suitable, too low, or too high?</p>	<p>According to the average illuminance provided for in the classroom (generally 300 lux or 500 lux), the power of the installation should ideally not exceed 6.6 W/m² (300 lux) to 11 W/m² (500 lux).</p> <p>Installed power of 11 W/m² for an illuminance of 500 lux may seem very demanding, but in reality, it is quite easy to achieve. Well-designed systems can reach 8 W/m² or 9 W/m² for 500 lux.</p>
<p>Are the light fittings efficient?</p>	<p>The fittings installed must have good energy performance. Some fittings, e.g. fittings holding bare tubes without reflectors, frosted glass etc. are not energy efficient. They absorb a large amount of the luminous flux.</p>
<p>Are discharge lamps supplied by electronic ballast?</p>	<p>The combination of electronic ballast + lamp consumes up to 20% less energy to produce the same amount of light as the combination of electromagnetic ballast + lamp. Moreover, the former combination gives an extended lamp service life.</p>
<p>Is the light source efficient?</p>	<p>The efficiency of light sources varies strongly according to the type of lamp.</p> <p>Incandescent bulbs have a low lighting efficiency (between 7 lm/W and 25 lm/W).</p> <p>The lighting efficiency of fluorescent lamps and energy-saving lamps is much higher (52 lm to 104 lm/W).</p>
<p>Is the control and management system efficient?</p> <p><i>- Is the system controlled automatically?</i></p> <p><i>- Does the lighting system automatically switch off in an unused room, whether by use of a timer or a movement detector?</i></p>	<p>If not, this means that there is a need for an awareness raising campaign among the people involved in the school, mainly teachers and pupils.</p> <p>However, management of the system according to available daylight allows savings of 30% to 50%.</p>
<p>Is the lighting system zoned at classroom level?</p>	
<p>Does the school have a light fitting maintenance or service plan?</p>	<ul style="list-style-type: none"> - Regular cleaning of light fittings, reflectors etc.; - Are fluorescent tubes automatically replaced at the end of their service life?

Comment:

SUBTASK C «Assessment of Technical Solutions and Operational Management» assessed the energy efficiency of existing lighting systems in the SUBTASK A exemplary projects – [see report XXX](#).

SUSTAINABLE REFURBISHMENT OF SCHOOL BUILDINGS

2. SERVICES AND ENERGY EFFICIENCY



2.6.8. Optimisation of the classroom lighting installation

2.6.8.1. *Setting goals*

Assessment of the installation both with regard to comfort and energy performance will enable identification of certain weaknesses or shortfalls in the artificial lighting of classroom premises.

On the basis of these results, goals must, first of all, be set:

→ Reduce consumption

Reduction of installed power will be sought, while assuring adequate and uniform illuminance.

The choice will be made of lighting and equipment (lamp, light fitting, ballast) offering the best energy efficiency. Supply of artificial lighting will be suited to real needs according to occupancy and natural daylight.

→ Improving comfort

In general, for classroom refurbishment natural daylight should be preferred and increased (see Chapter «Comfort»). The installation of artificial lighting must be considered as supporting natural daylight.

If the renovation aims to improve luminance comfort, attention will be paid to the choice and positioning of light fittings, without forgetting the colour of emitted light, the illuminance level and the colour of walls.

It is possible that electricity consumption will not be reduced following renovation. The installed power may remain effectively the same, but improved efficiency of lamps or light fittings and more suitable positioning of the latter will enable achievement of the recommended illuminance level and elimination of problem reflections, shadows or glare.

European standard EN 12464-1, «Lights and lighting – Lighting of workplaces, Part 1: Indoor work places» recommends a minimum level of illuminance of 300 lux on the work surface in nursery, primary and secondary school classrooms, while this same Standard recommends 500 lux for adults.

European Standard EN 15251 also recommends a minimum level of 300 lux.

→ Reducing the cost of maintenance and servicing

The efficiency levels of lamps and light fittings must remain valid for as long as possible. Ideally, lamps with a long service life will be chosen, but the light fitting must also ensure that efficiency is maintained over time. In addition, quick maintenance may be required in order to reduce major labour-related costs.

2.6.8.2. *Types of renovation proposed* (Source: <http://www.energieplus-lesite.be/index.php?id=15948>)

Next, and according to the available budget, two types of renovation of the installation may be proposed.

→ Partial renovation

Partially renovating the lighting installation consists of replacing energy intensive or inefficient components of the installation: whether lamps, ballast or optical elements, without doing too much to the existing installation.

In other words, insofar as the light fittings, their supply cables and their control and management system are not removed, the renovation can be considered to be partial.

→ Complete renovation

Complete renovation of the lighting installation comprises replacing all light fittings and reviewing their management. Complete replacement is more onerous, but generally leads to greater energy savings. It allows a wider choice of equipment and for choices to be better suited to needs.

This being so, it assumes the ability to:

- modify and/or replace false ceilings (in the case of recessed lighting);
- modify the electrical circuit and install additional controls and management devices.

Such complete renovation really comprises the design of the new lighting system. This type of renovation will not be dealt with below.

→ Further detail – case study IEA SHC Task 50

Renovation of lighting installations in schools was also the subject of TASK 50 of the IEA SHC Programme «Advanced

SUSTAINABLE REFURBISHMENT OF SCHOOL BUILDINGS

2. SERVICES AND ENERGY EFFICIENCY



Comment:

If the lighting installation is more than 15 years old and if the premises are used daily, complete renovation should be considered. The technologies of lamps, light fittings, and control and management systems has developed so much that complete renovation of the installation would enable major savings, in the order of 30% to 70%.

Lighting Solutions for Retrofitting Buildings»– task50.iea-shc.org.

SUBTASK D of this Task involves detailed analysis of case studies. The selection of Case Studies will be based on a general building stock analysis, including the distribution of building typology in relation to lighting retrofit potential. These case studies will deliver proven and robust evidence of achievable savings and show integrated retrofit strategies. Measurements and assessments will include monitoring of energy savings, lighting quality and operational costs. In addition, Subtask D will provide updated information from an analysis of previously documented Case Studies in the literature and on websites.

2.6.8.3. *Lamp replacement*

Lamp replacement may be considered in several ways:

→ Removing lamps

When the illuminance level is excessive, it can be reduced by the removal of e.g. one in two lamps in the existing light fittings. The feasibility of such action must be confirmed by inspection of the type of internal wiring of the light fittings: there needs to be a ballast, a starter and a condenser for each lamp.

It is also necessary to make an intelligent reduction in the number of lamps while retaining the recommended uniformity.

→ Lamp replacement

The lamps are simply replaced by lamps with a better lighting efficiency. This is often referred to by professionals as «relamping». This replacement can be carried out by:

- Replacement of all the lamps at once, which requires higher investment, but will soon pay for itself.
- Replacement of lamps when they are diverse. In this case, investment is zero, but the energy-saving will take some time to become significant.

When there is an inadequate level of lighting, replacement by lamps with better luminous efficiency enables increased luminous flux for the same power input.

If the lighting installation comprises incandescent lamps, their replacement must be considered as these are too energy intensive. From an energy efficiency point of view, it is easy to remove an incandescent lamp to replace it with a more efficient lamp. From the point of view of comfort, it is different, given that an incandescent lamp gives the best white light. When carrying out replacement, account must also be taken of the photometry of the light fitting, colour rendition, colour temperature and the lamp's capacity to withstand frequent switching on, dimming etc.

Incandescent lamps may be replaced by, in increasing order of energy efficiency: halogen lamps, compact fluorescent lamps and/or LEDs.

It can also be worthwhile to replace 38 mm diameter fluorescent tubes (old generation) with 26 mm diameter tubes, which have a greater luminous efficiency. They are the same length, have the same cap and use the same ballast (except for rapid-start fluorescent tubes). They are, therefore, interchangeable.

2.6.8.4. *Ballast replacement*

Replacement of existing ballast in light fittings may be considered, but it is important to remember that the cost of labour for this type of renovation work is quite considerable. Indeed, replacing the ballast for a light fitting requires the fitting to be taken down, the ballast to be replaced, rewiring of the light fitting and remounting it.

It is sometimes better to completely replace the light fitting.

→ Replacing electromagnetic ballast with electronic ballast

With an installation that already has efficient lamps and optical qualities, it is, however, not very cost efficient to only replace electromagnetic ballast with electronic ballast.

SUSTAINABLE REFURBISHMENT OF SCHOOL BUILDINGS

2. SERVICES AND ENERGY EFFICIENCY



→ Replacing existing ballast with dimmable electronic ballast

In classroom premises, where there is always natural daylight, one can consider the question of replacing existing ballast with dimmable electronic ballast, which will manage the level of artificial illuminance according to availability of natural daylight.

If the existing ballast is already electronic, the investment approved for replacement ballast will not produce a saving, but will produce better energy use.

If the existing ballast is at the end of its service life and replacement is necessary, one could possibly consider replacing it with electronic dimmable ballast and a simple management system for dimming the lighting according to available daylight.

If the existing ballast is electromagnetic, its replacement will enable an energy-saving of approximately 20%.

2.6.8.5. *Replacement of optical elements*

Frequently, poor performance of and discomfort from an old lighting installation (over 20 years old) can be attributed to older generation optical elements (lack of reflectors; yellowing, frosted diffusers; prismatic diffusers etc.).

Thanks to the development of mirrored optical elements, the lighting efficiency of light fittings has now increased from 40% to more than 70%.

For large buildings, such as some school buildings, it can be worth conserving the frames and providing them with fittings including a mirrored optical element, parabolic louvres and electronic ballast.

The equipment is preassembled and simply needs to be connected into the existing casing. This operation does not require changes to ceilings, controls or any removal of light fittings. Therefore, it can be carried out quickly, without significant disruption of activities.

Simply replacing the optical equipment does not reduce energy consumption, since the installed electrical power remains unchanged, but it does improve visual comfort. Thus, improvement of the efficiency of light fittings should be accompanied by reduction of the total power of lamps (removal of lamps, or reduction of their power).

The drawback of this type of renovation is the retention of current positioning of light fittings, which might either not be ideal, or no longer be suitable for changed occupancy of the premises.

2.6.8.6 *Improving control and management of the system*

→ Raising the building users' awareness

A lighting management system will only work if it is completely accepted by the occupants. This is why it is often advised that the search for economy should not be pressed too far and to the detriment of users' freedom and simplicity of the system.

In the first instance, behaviour can be influenced by informing and motivating the user, without altering the method of controlling the system. In this case, it will be that much easier to get the users' cooperation if they have personal, ergonomic controls.

Pupils and teachers need to be made aware about:

- Not using the main artificial lighting if there is sufficient natural light;
- Switching room lighting off when they leave the room.

→ Zoning

An initial improvement measure is the creation of lighting system zoning in the classroom, differentiating between the row of light fittings near the windows and the other light fittings. The row of light fittings near the windows will, thus, be controlled by a different switch from the other light fittings.

→ Management by non-occupancy

A second improvement measure is to control the switching off of lights by means of a non-occupancy sensor. Even if users have been made aware about not using and switching of artificial lighting, this is frequently forgotten.

→ Management according to natural daylight

For classroom premises, very considerable energy-saving can also be obtained by automated management of lighting according to natural illuminance.

If measurements taken on the refurbishment site show high availability of natural daylight in the classrooms, it will be

SUSTAINABLE REFURBISHMENT OF SCHOOL BUILDINGS

2. SERVICES AND ENERGY EFFICIENCY



worth using light sensors to control the lights (switching on and off or dimming, according to the amount of daylight, using darkness sensors).

For visual comfort, dimmable electronic ballast is more useful than an on/off switch.

If the system has already been zoned, consideration may be given to installing a light sensor at the row of light fittings close to the windows.

2.6.8.7. *Improving maintenance*

The ageing of the lighting installation will show itself by a gradual loss of efficiency and, after a certain time, by the incidence of lamp failures.

Loss of lighting efficiency can be caused by:

- A lowering of the emitted luminous flux in the range of 7% to 50% at the (average) end of the lamps' service life.
- A reduction in efficiency of the light fittings, linked to their being coated with dust and yellowing of optical elements and light sources. This reduction is in the range of 5% to 26% in clean premises, if the light fittings are cleaned every three years.
- Reduced reflective qualities of the premises.

→ **Lamp maintenance**

The goal of replacement is to restore to the installation all or part of its initial efficiency. There are three possible types of maintenance programme:

- Preventive: replacement, at regular intervals, of all of the lights at once;
- Remedial: replacement of unserviceable lamps as needed;
- a combination of the above two programmes.

→ **Cleaning of light fittings and of premises**

While most premises are regularly cleaned (floor cleaning and furniture dusting), the lighting installation and some surfaces (ceiling, walls, windows) receive little or no maintenance (lower frequency).

However, lamps, light fittings and walls do get dusty. This dust has a not inconsiderable impact on lighting efficiency. If cleaning is carried out annually, one can expect a 10% to 15% reduction in illuminance. The frequency of cleaning should be set according to the amount of dust. Generally, cleaning every six months gives good results.

Cleaning includes both lamps and light fittings.

The maintenance schedule should also take into account cleaning and freshening glazing, walls and ceilings and curtains, which contribute to the natural lighting of the premises.

→ **End of service life of lamps, light fittings and auxiliary equipment, and recycling**

Some worn out or defective lamps may contain toxic materials (mainly mercury), which must not be allowed to escape into the atmosphere or the ground.

In Europe:

- Incandescent lamps are considered Class 2 waste and included in domestic waste.
- Compact fluorescent lamps and tubes are considered Class 1 waste and included in dangerous waste (mercury content).

Compact fluorescent lamps and tubes are collected in sorting centres or by approved companies and are then mainly recycled. Treatment consists mainly of crushing, which enables separation of fluorescent powders, glass and metal components. The most sophisticated and latest techniques enable recovery of pure materials suitable for the manufacture of new lamps.

SUSTAINABLE REFURBISHMENT OF SCHOOL BUILDINGS

2. SERVICES AND ENERGY EFFICIENCY



2.7. Electricity production through cogeneration systems.



Cogeneration (also known as «combined heat and power») is the combined production of electricity (1/3) and heat (2/3). Cogeneration enables the saving of primary energy (in the case of Belgium: between 15% and 20%) and reduction of polluting emissions, including some greenhouse gases.

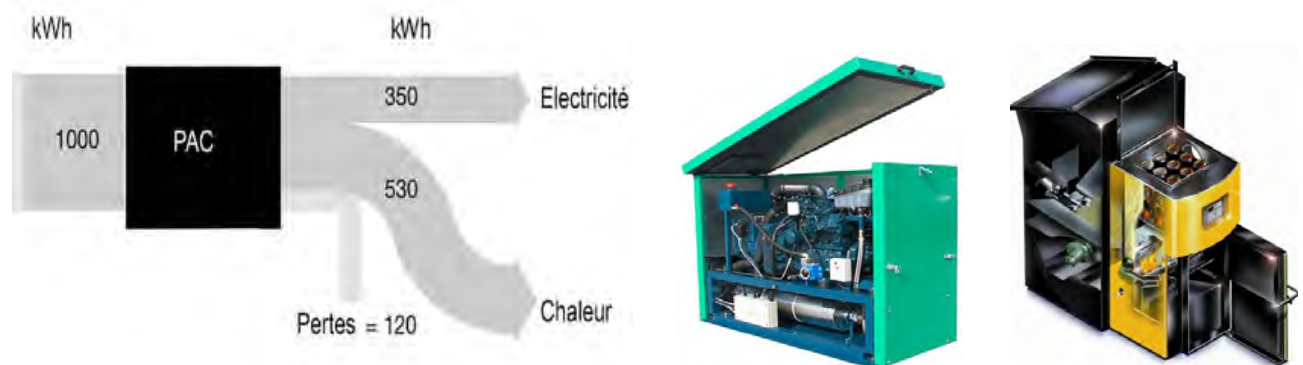

Heat recovery uses existing power generation technologies, i.e.

- Generator units (internal combustion engine)
- Gas, biogas or fuel oil turbines
- Steam turbines – steam engine
- Stirling engines (external combustion engine)
- Fuel cells

Various fuels can be used:

- Fossil fuels: gas, fuel oil, propane etc.
- Renewable fuels: wood, biogas, biodiesel, oils etc.

Most facilities operate either on natural gas or biomass. Small facilities or micro-cogeneration mainly operate on natural gas. Some designs can operate on either biogas or biodiesel.

When designing a cogeneration system, two factors have to be brought into the equation:

• The economic factor

The cogeneration system will not be designed to cover all heating needs, but only the base load. A cogeneration unit does not completely replace a boiler, but it is a useful supplement. Insofar as the heating demand matches normal operation of the cogeneration system, this provides the heat generation. During periods when little heat is needed, it is the boiler that provides the heat generation.

In other words, the cogeneration system needs to operate for as long as possible during a year for it to be cost-effective.

• The technical factor

This factor is linked to flexibility of generation. Generally, cogeneration systems require long generation cycles for good performance, but also for a good service life (essentially mechanical).

SUSTAINABLE REFURBISHMENT OF SCHOOL BUILDINGS

2. SERVICES AND ENERGY EFFICIENCY



In any refurbishment project, before investing in a cogeneration system, a feasibility study needs to be carried out to satisfy oneself of the technical and economic usefulness of the project. This should be done in the knowledge that the primary purpose is to reduce energy and environmental costs both with regard to heating (possibly HWS) and electricity. For a school building refurbishment project, where the envelope will have been optimised and heating needs thus reduced, it is possible to question the technical and economic usefulness of this type of installation.

- In southern and central Europe, if heating needs are reduced (better insulation and airtightness), given the internal gain to classroom premises (number of occupants per class, artificial lighting), the installation of cogeneration will not be cost-effective.
- In the Nordic countries, especially Norway, given the price of electricity, it is currently difficult to improve on the cost effectiveness of an electric heating system (direct or heat pump).

For these various reasons, we will not pursue this theme in this publication. Nonetheless, we suggest a number of reference works:

- **Guide Bâtiment Durable**, Bruxelles Environnement, Bruxelles - <http://guidebatimentdurable.bruxellesenvironnement.be/fr/index?IDC=3>
- **Energie Plus website** - www.energieplus-lesite.be
- **Installer une cogénération dans votre établissement - Guide de pré-faisabilité pour les acteurs du secteur tertiaire et PME**, Energie Wallonie - <http://energie.wallonie.be/fr/installer-une-cogeneration-dans-votre-etablissement-guide-de-pre-faisabilite-pour-les-acteurs-du-secteur-tertiaire-pme-p.html?IDD=11652&IDC=6110>
- **Cogénération et micro-cogénération, Solutions pour améliorer l'efficacité énergétique**, Méziane Boudelal, Technique et Ingénierie, Dunod / L'Usine nouvelle
- **Intégrer les énergies renouvelables, choisir, intégrer et exploiter les systèmes utilisant les énergies renouvelables**, Alain Filloux, Guide «Bâtir le développement durable, CSTB, juin 2010

SUSTAINABLE REFURBISHMENT OF SCHOOL BUILDINGS

2. SERVICES AND ENERGY EFFICIENCY



2.8. Power generation from renewable sources



2.8.1. Preliminary remark

There are currently various renewable energy sources for the generation of electricity:

- Solar energy,
- Wind power,
- Hydraulic power,
- Biomass,
- Electricity production through cogeneration systems.

The development and growth of all these sources is, in general, to be encouraged, but at the scale of school buildings and their refurbishment, only some generation systems can easily be integrated:

- Photovoltaic solar systems;
- Electricity generation by linking a cogeneration system to the heating system, for schools with a high hot water requirement (see Point 4).
- Small wind turbines.

In this document, we shall only discuss electricity generation using photovoltaic panels, which are of both financial and environmental interest

Why change over to renewable energy?

World energy use has a current 80% reliance on fossil fuels. Most of these energy sources will be exhausted in a few decades with, as a consequence, a noticeable price increase (the effect of supply and demand).

Moreover, many deposits of these resources are located in regions that are politically unstable or hard to access, which renders supply difficult. This is a second cause of price increase.

Further to this, fossil fuel resources need to be burned to generate energy, which is currently the cause of numerous problems involving pollution (global warming, environmental acidification, generation of ground-level ozone etc.) and health (respiratory problems, allergies etc.).

Photovoltaic collectors use solar energy to generate electricity from light, through the photovoltaic effect. Using free, clean and renewable energy, this fast-evolving technology brings together the interests of ecology and economy. It enables:

- The use of otherwise unused surfaces for energy generation (e.g. roofs, facades, carports etc.).
- Partial (even total) offsetting of electricity consumption, together with and suited to prudent and efficient management of electricity consumption. Ideally, it should supplement rather than replace Rational Use of Energy.

2.8.1.1 Operating principle

The photovoltaic effect was discovered by Alexandre Edmond Becquerel in 1839. The photovoltaic effect is obtained by absorption of photons in a semiconductor material, which then generates electrical power.

Every photovoltaic system connected to the grid comprises the following components:

- an array of panels (generator) made up of photovoltaic cells (1).
- a junction box (2). Depending on the type of connection, it enables the connection in parallel of several strings (panels connected in series) It also enables the installation, if necessary, of protection against surges in the

SUSTAINABLE REFURBISHMENT OF SCHOOL BUILDINGS

2. SERVICES AND ENERGY EFFICIENCY



cells and inverter.

- an inverter (3) that converts the direct current produced by the panels into usable, alternating current.
- at least one electricity meter (4). In Belgium, every installation includes a green certificates meter, as well as the ordinary electricity meter.
- a junction box to the supply grid (5).

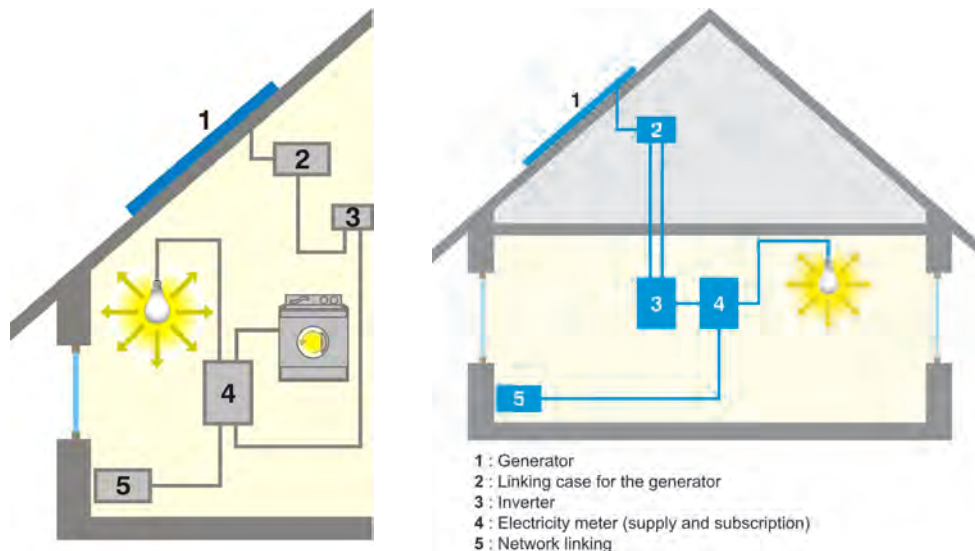

Direct current is generated in the solar panel cells by incident light. The array of interlinked panels forms a photovoltaic generator.

Direct current produced by the generator is transmitted to the generator junction box and then to an inverter. The inverter converts the direct current to alternating current. There are then two options:

- All of the alternating current power is fed into the public electricity grid, via a supply meter; The receivers will get the power required for their operation via an account meter, which separates it from the local electricity network;
- Alternating current produced is not fed to the public grid and is either consumed on site or stored in accumulators.

For school buildings, it is worthwhile to directly consume the electricity produced during working hours and to be able to feed power generated to the public grid during holiday periods.

2.8.1. General concepts : silicon wafers - cell/panel - generator

The basic material for crystalline solar cells is a silicon wafer 0.2 mm to 0.3 mm thick. The photovoltaic effect is produced inside these small components. When the various layers of semiconductors that make up the solar cell are exposed to light, a potential difference is produced. This phenomenon is measured externally as a voltage. To be used, the voltage must be amplified by traversing several cells in series.

A panel is generally made up of solar cells connected in series. The maximum number of cells (= voltage of the panel) is mainly limited by the conditions of installation and use of the panel (weight and size).

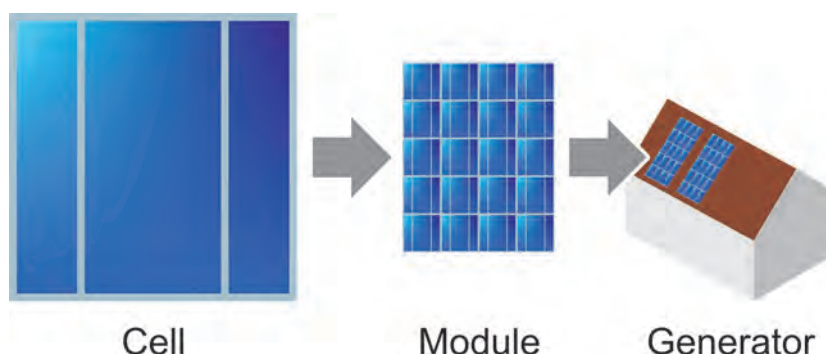

SUSTAINABLE REFURBISHMENT OF SCHOOL BUILDINGS

2. SERVICES AND ENERGY EFFICIENCY



When several panels are connected in series to assemble a photovoltaic system, they are known as a string. The set of strings of connected panels (even if there is only a single string) is called a generator.

2.8.3. Photovoltaic cell

A photovoltaic cell is an electrical component which generates an electrical voltage, when exposed to sunlight, through the photovoltaic effect. All photovoltaic cells are made from semiconductor materials. Usually this is silicon (Si), but one also finds cadmium sulphide (CdS), cadmium telluride (CdTe), alloys of copper e.g. copper indium diselenide (CIS) etc.

2.8.3.1 Types of cell

There are three current photovoltaic cell technologies, according to mode of production:

→ First generation: crystalline cells

The manufacturing technique for these cells, based on production of wafers from very pure silicon, remains very energy intensive and expensive.

Manufacturing method: the crystal is formed by cooling molten silicon in parallelepiped crucibles and is then cut into fine slices called wafers. The cells are then produced after doping and surface treatment.

There are two types of crystalline cell:

• Polycrystalline cells

Cooling of the silicon infusion is carried out in flat-bottomed parallelepiped crucibles. With this technique, crystals form in irregular orientation. This gives these cells their characteristic blue appearance with patterns generated by the crystals.

Efficiency

11% to 15% (thus giving a power of 110 Wc to 150 Wc per m²)

These cells are still the ones most used, because of their better price/performance ratio compared with monocrystalline cells.

Advantages

Price/performance ratio

Disadvantages

Low performance in low light conditions

• Monocrystalline cells

The cells are made up of very pure crystals obtained by cooling the silicon carefully and gradually.

Efficiency

12% to 19% (thus giving a power of 120 Wc to 190 Wc per m²).

Advantages

Very good efficiency.

Disadvantages

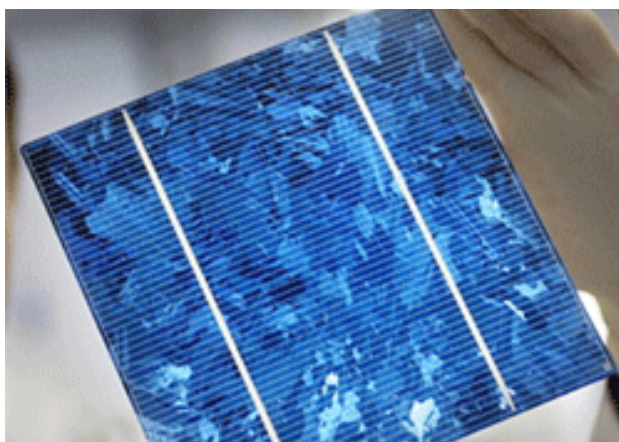

Source: www.solar-construction.com

SUSTAINABLE REFURBISHMENT OF SCHOOL BUILDINGS

2. SERVICES AND ENERGY EFFICIENCY



High cost;
Low performance in low light conditions

→ **Second generation: thin films**

For thin films, the semiconductor is directly laid by vapour deposition onto a support material (e.g. glass). Amorphous silicon (a-Si) (dark grey, non-crystalline silicon), cadmium telluride (CdTe) and copper indium diselenide (CIS) are the main components of this generation. Cells produced by this technology are those one finds in solar watches, calculators etc.

• **Amorphous silicon**

In contrast to crystalline cells, the active semiconductor material is much finer.
Less of the basic material is, therefore, required than for crystalline silicon cells.

Efficiency

60 Wc/m² – 70 Wc/m².

Advantages

Less expensive than first-generation cells, as they use less semiconductor material;
Manufacture is less polluting (the stage of transforming the silicon into wafers is unnecessary, so it is less energy intensive);
Operates in low light conditions;
Less sensitive to shadows and temperature increases;
Can be made into flexible panels.

Disadvantages

Lower overall performance;
Lower performance in direct light;
Greater loss of efficiency over time.

There are **other types of thin film cells**: cadmium telluride (CdTe), copper indium diselenide (CIS) etc.

CdTe gives good performance, but cadmium's toxicity remains a problem for its manufacture.

CIS cells give an efficiency in the region of 17% in laboratory conditions and up to 11% for commercially available cells.

→ **Third generation: multijunction**

To improve cell efficiency, current research is exploring a number of avenues, in particular:

- Multilayer cells: superimposition of multiple cells with different properties (using different energy bands, allowing a wider sweep of the solar spectrum). This type of cell is already marketed, but mainly for space applications. The concentrated efficiencies obtained are very promising (in the order of 30%).
- Concentrated solar cells (enable the use of low-energy photons, which are not usually absorbed by photovoltaic cells).
- Organic solar cells etc.

SUSTAINABLE REFURBISHMENT OF SCHOOL BUILDINGS

2. SERVICES AND ENERGY EFFICIENCY



Source: www.solar-construction.com



Source: www.solar-construction.com

2.8.3.2. Operation of cristalline cell

The targeted supply (doping) of foreign atoms (usually boron and phosphorus) enables two layers, with different electronic properties, to be created within the cell:

- Positive layer «p»,
- Negative layer «n».

An electrical field forms at the edge of these two layers, This is the space-charge region (SCR).

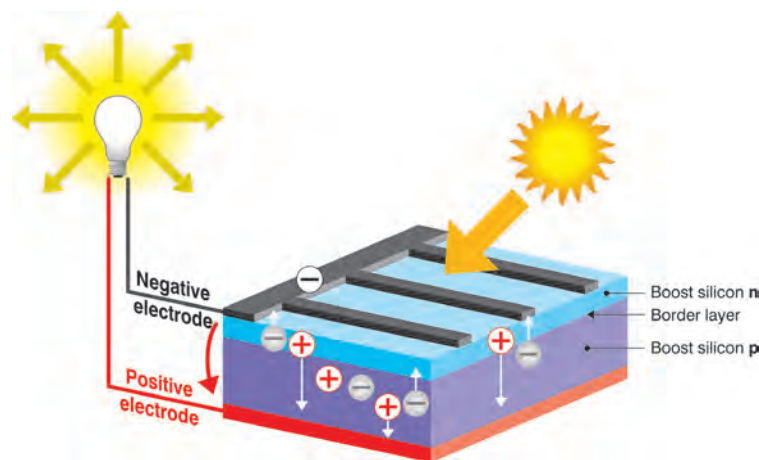

When the cell is illuminated, the electrical charges in the space-charge region separate. A voltage of 0.5V DC forms in the electrical connection, largely independent of illuminance.

2.8.3.3. Maximum power

The current and electrical power of a solar cell depend directly on the intensity of the luminous flux.

The cells provide to the maximum amount of energy when the sky is clear and sunny. In diffuse lighting conditions (cloud cover), the luminous flux is weaker and, consequently, so is the power generated.

The maximum power of a cell is defined on the basis of a luminous flux of 1000 W/m² at a temperature of 25° C. It is known as the peak power and is expressed in W_p (peak power Watts).

2.8.3.4. Current and voltage

A solar cell is characterised by:

- Current: dependent upon the strength of luminous flux and the size of the cell;
- Voltage: mainly dependent upon the material of which the cell is made.

The only means to increase voltage is to assemble several cells in series. A series of several cells is called a string.

SUSTAINABLE REFURBISHMENT OF SCHOOL BUILDINGS

2. SERVICES AND ENERGY EFFICIENCY



2.8.3.5. Effect of temperature

The heating of the solar cell causes a reduction in output. For crystalline cells, the loss of output is 0.5% per degree Celsius. Thin film cells are less sensitive than crystalline silicon cells.

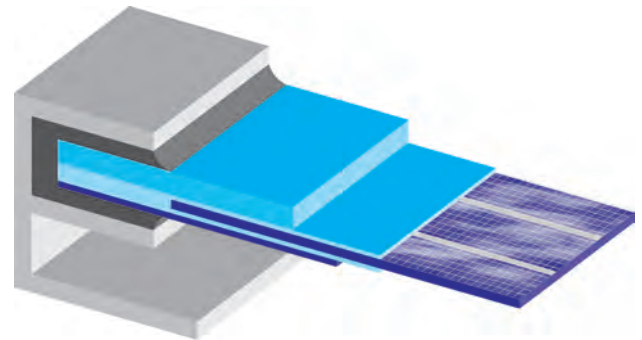
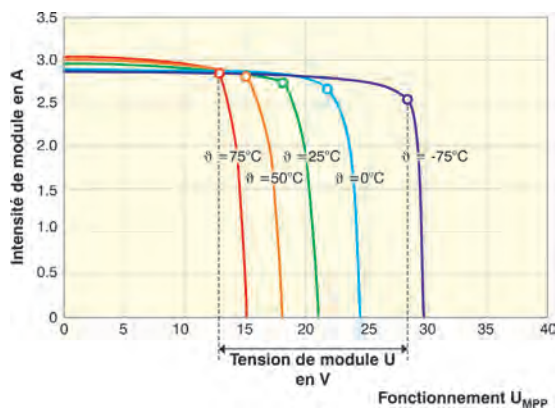

Therefore, any heating should be avoided. This is why installations providing ventilation to the rear surface of the module are to be preferred.

2.8.4. Panel

A panel is made up of several strings.

Joining cells into panels enables:

- An adequate voltage to be obtained;
- Protection of the cells and their metal contacts from the outdoor atmosphere (humidity etc.);
- Mechanical protection of the cells (impacts etc.).

The photovoltaic panel is generally made up of:

- Several solar cells connected to each other;
- Glazing (or laminate) for protection against bad weather;
- Surge protection by means of one or more bypass diodes;
- A connection device;
- Glazing to the rear surface;
- An aluminium frame.

The most common type of solar panel, found inter-alia for roof mounting, is the Tedlar glass panel.

There are however other types of panel, e.g. glass-glass solar panels, used for their translucent qualities: for glass canopies, facades etc.; or solar tile/slate panels, where the cells are directly integrated into panels shaped like traditional roofing. These are often more demanding with regard to labour. Other thin-film type panels have also recently appeared on the market. They are generally arranged on a flexible support (Teflon etc.).



Source: www.etemit.be



Source: www.solar-construction.com

SUSTAINABLE REFURBISHMENT OF SCHOOL BUILDINGS

2. SERVICES AND ENERGY EFFICIENCY



In order to manufacture a panel, several solar cells are electrically connected to each other (connected in series), so as to achieve the necessary voltage and current at the panel outlet. Each series is protected by a bypass diode which enables:

- Avoidance of heating, in the event of shadows falling on some cells, causing breakdown or damage;
- Limitation of the loss of efficiency, for the panel as a whole, that would result from such heating.

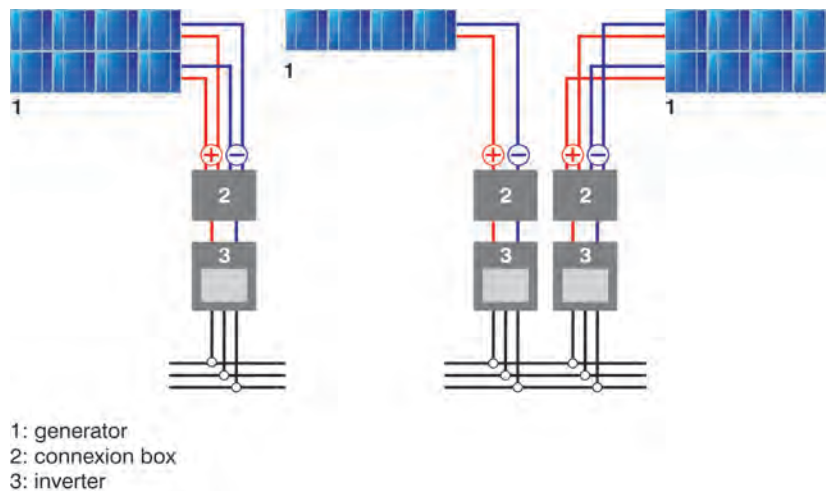

The panels are connected to each other (in series or in parallel) by electrical wires. Thus, they form an array of collectors (also known as a generator).

2.8.5. Inverter

Most of our current electrical devices work on alternating current, while a photovoltaic installation produces direct current. The primary role of an inverter will be to effect that transformation to alternating current. However, it does more than that. It must also enable:

- Tracking the maximum power point (MPP tracker) in relation to the current and voltage generated by the panels, e.g. by adjusting resistance.
- Synchronisation with the earth network in order to be able to reinject current generated. For this purpose, it must alter the voltage (transforming), frequency and resistance.
- Automatic disconnection in the event of voltage drop in the network.
- Observation and recording of typical operating values needed for maintenance and monitoring of the installation.

An inverter has well-defined operating ranges:

- Maximum power;
- Minimum and maximum voltages;
- Maximum current.



SUSTAINABLE REFURBISHMENT OF SCHOOL BUILDINGS

2. SERVICES AND ENERGY EFFICIENCY



These values must be consistent with the specifications of the array of collectors to avoid any risk of malfunction or even damage to the equipment.

2.8.5.1. Possible configurations

There are various possible configurations for positioning one or more inverters in relation to the photovoltaic panels: on each panel, string, array of collectors etc. The ideal configuration for an installation (connection of panels in parallel-series and location of the inverter) mainly depends on the homogeneity of the array of collectors (shadow, orientation and slope, types of cell, failures, dirt etc.).

→ Central inverter – one inverter controls the whole installation

With this configuration, the inverter does not distinguish differences between characteristics of the currents produced by the different strings. In fact, they are pre-coupled at the junction box. It is from this current (with an amperage equal to that of the sum of the currents and with a voltage equal to the highest voltage of the different strings), as actually detected by the inverter, that the latter adapts its intake settings to make the photovoltaic generator operate at its maximum power point.

Advantages

Cost,
Simplicity and speed of assembly

Disadvantages

The outlet voltage and thus power generation is very easily upset by a weaker string (shade, number of panels,

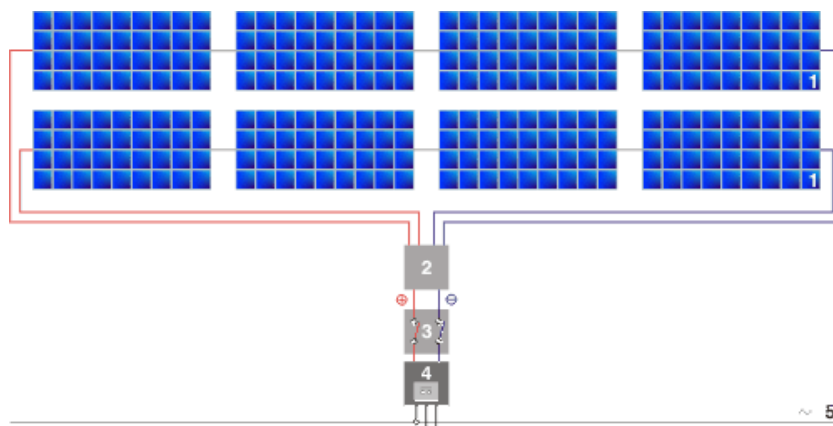

type of cell etc.).

This type of connection does not permit working with strings of different types without considerable impairment to generation.

→ String inverter - one inverter per string

In this configuration, each inverter can optimise the operation of each string.

Advantages

Tracking the maximum power point (MPP) for each string.

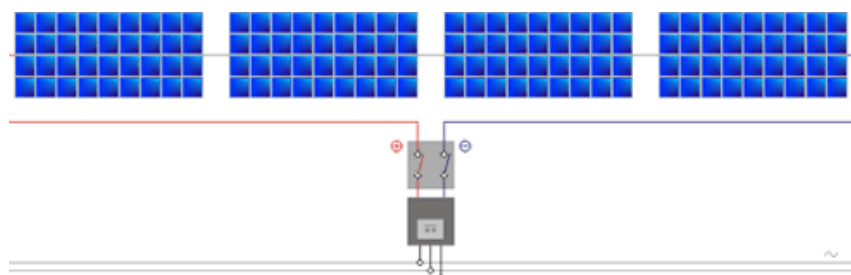

SUSTAINABLE REFURBISHMENT OF SCHOOL BUILDINGS

2. SERVICES AND ENERGY EFFICIENCY



Disadvantages

Effect of loss of efficiency of a panel (due to shadow, dirt, or failure) on the performance of the panels in the string.

→ **Multi-string inverter – one inverter controls various strings in parallel**

With this option, more or less combining the string and centralised configurations, each inlet is equipped with its own MPPT. The different direct currents generated are first synchronised before being transformed into alternating current.

Advantages

Combination of different types of string (types of cell, orientation, numbers of panels etc.) without overall interference with efficiency.

Clearly greater efficiency as compared with the centralised configuration, where there are different types of string.

→ **Modular inverter – one inverter per panel**

Advantages

Ease of use;

No direct current cabling;

Each module is independent (shadow on one panel and its resulting loss of efficiency does not affect generation by other panels. Similarly breakdown of an inverter does not affect other modules).

Disadvantages

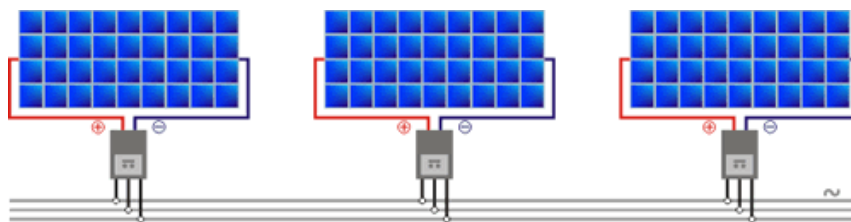

Cost,

Maintenance: in general this type of inverter is directly integrated with the panel. If it fails, the panel needs to be replaced (though its service life is usually longer than that of the panel).

In the case of a high output generator, when the cells are partially shaded, or when the panels have different slopes and/or orientations, use of string (multi-string) inverters or modular inverters is preferred.

2.8.5.2. *Assembly and connection*

The connection of different panels to each other can be done either in series or in parallel, according to the location and specifications of the inverter intake.

For assembly in parallel, the current of the different panels is summed and the voltage remains the same.

For assembly in series, the voltages are summed and the current through the panels remains the same.

→ **Assembly in series (summing of generated voltages)**

This type of assembly allows:

- Quick and easy assembly;
- Use of small sections of cable, without increasing conduction losses of direct current. (Power losses are, actually, a function of amperage squared).

It is mainly suitable for the most homogenous installations (without shadow, with identical orientation, identical slope, panels with narrow power tolerance range etc.). In this case, defects, shadow etc. will affect all the generation by panels connected in series.

→ **Assembly in parallel (summing the amperage generated)**

This type of assembly, on the contrary, is particularly suitable for more heterogeneous installations (different shadow, slope, orientation etc.), or when permitted voltages per installation are limited.

SUSTAINABLE REFURBISHMENT OF SCHOOL BUILDINGS

2. SERVICES AND ENERGY EFFICIENCY



In practice, one would endeavour, as far as possible, to connect in series the maximum number of panels with identical specifications (strings).

In general, care will be taken to limit the length of and carefully design the cabling between panels. Correct specification of cable diameter allows avoidance of excessive heating and, thereby, unnecessary conduction losses.

With low partial load, i.e. when the luminous flux is weak, inverter efficiency is lower.

To reduce the time that any single inverter is operating at low load, several communicating inverters can be used.

The principle is simple: if there is high illuminance, several inverters work together at full load; if, on the contrary, illuminance is weak, only a single inverter is in operation.

There are two possible scenarios:

- Inverters switching on and off according to need: master/slave principal . Connection is the same as for the centralised configuration.
- Strings either distributed to different inverters or not: team principal . This configuration is an extension of the string inverter configuration.

2.8.6. Designing a photovoltaic system for a refurbishment project

The objective is meeting the needs as far as possible, according to availability of surface area and budget.

The choice of the system depends mainly upon:

- The available surface area and its configuration (size, slope and orientation);
- Absence of shadows or impediment to solar radiation;
- Available financial capacity for investment;
- Technical and aesthetic demands of the project owner.

2.8.6.1. *Choosing the panels' position*

In any refurbishment project, before proceeding with installation of a photovoltaic system, some questions must be posed:

- Are there unused surfaces (roof, facades, ground-level space etc.) that can be used for power generation?
- Are these large surfaces? Are they well oriented? Are they shaded?
- In the case of installation on a roof, is the roof still in good condition?

The choice of where panels are to be positioned may involve several of these factors:

→ Available surface area

The available surface area determines the generating capacity that can be installed, according to the type of cell chosen.

In general, the maximum size of installation is limited by the available roof surface area.

A 1 kWc generating capacity requires the following surface areas:

- 6 m² of monocrystalline cells (considering a peak power of 165 Wc/m²),
- 8 m² of polycrystalline cells (considering a peak power of 125 Wc/m²),
- 15 m² of amorphous cells (considering a peak power of 66 Wc/m²).

→ Orientation and slope

In order to maximise power generation by an installation, the panels should be optimally oriented and sloped in order to collect the maximum solar radiation.

Solar tracking systems, also known as sun trackers allow continuous adjustment of the panels' slope and orientation. This type of installation enables an increase of approximately 25% in the output as compared with a fixed installation. However, it also entails considerable extra cost.

Orientation

In general, in the northern hemisphere, a South orientation will be chosen, or one approaching that (South-East or South-West).

As high temperatures adversely affect panel efficiency, preference will also be given to an East rather than a West orientation (as temperature is lower in the morning).

Slope

SUSTAINABLE REFURBISHMENT OF SCHOOL BUILDINGS

2. SERVICES AND ENERGY EFFICIENCY

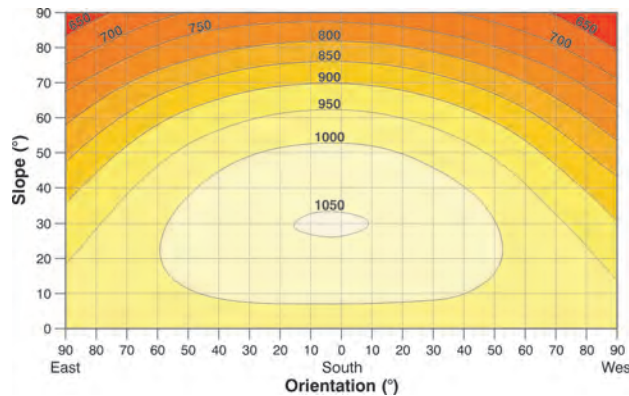

With regard to the slope of panels from horizontal, the approach is based on the height of the sun in the sky. The height of the sun depends on both latitude and season. Solar energy collected by a surface will be greater if that surface is perpendicular to the direct rays of the sun.

Orientation and slope: correction factor

Optimum efficiency is obtained with a South orientation and a slope of 35° from the horizontal.

If one departs from that, efficiency decreases. To quantify this decrease of efficiency, one applies a correction factor to the kWh obtained per year and per kWc. The values of this correction factor are given in the table below.

Tracker system

There are mobile installation systems, known as sun trackers, which enable power generation to be maximised by fol-

© www.ef4.be		inclinaison par rapport à l'horizontale (°)						
		0	15	25	35	50	70	90
orientation	est	88%	87%	85%	83%	77%	65%	50%
	sud-est	88%	93%	95%	95%	92%	81%	64%
	sud	88%	96%	99%	max 100%	98%	87%	68%
	sud-ouest	88%	93%	95%	95%	92%	81%	64%
	ouest	88%	87%	85%	82%	76%	65%	50%

lowing the sun on its daily course (orientation and slope).

a sun tracker can have two degrees of freedom of rotation: horizontal to adjust the zenith and vertical for the slope. Different types:

- Single axis trackers: (generally) enable the sun to be tracked from East to West;
- Dual axis trackers: enable adjustment of orientation and slope. The latter requires the use of two motors.

There are two different systems for tracking:



SUSTAINABLE REFURBISHMENT OF SCHOOL BUILDINGS

2. SERVICES AND ENERGY EFFICIENCY



- Active system: equipped with a light sensor, it enables instant tracking of the optimum position. If the sky is overcast (diffuse solar radiation), such a system moves the module into the horizontal position, which gives maximum efficiency for these conditions.
- Astronomical system: the position is a direct function of the pre-programmed course of the sun.

Other, anemometer type, sensors enable trackers to adopt a safe position in the event of bad weather.

→ Shadows

Over and above the loss of performance that may result from an incorrect slope or orientation, shadows on photovoltaic panels have a very negative effect on their performance.

In fact, these panels are made up of cells linked in series.

This connection in series means that the cell with the weakest performance will determine and limit the output of the whole module.

It is thus essential to choose a position that is affected as little as possible by fixed shadows from the environment and existing buildings around the collection surface.

On a flat roof, particular attention should be paid to shadows cast by panels on each other.

→ Type of fixing

Various types of fixing can be considered according to the availability of the site and potential collection surfaces.

• Sloping roof

Panels are attached to the roof structure of a sloping roof using metal brackets.

Panels may either be located above or integrated into the roof.

If the panels are integrated into the roof, they then replace the roof covering, as can be done with solar tiles.

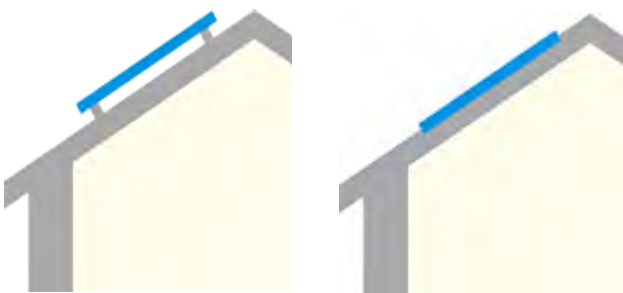

Possible heating of the cells is, in this case, a problem that must be taken into account.

If panels are integrated into the roof, it is more difficult to dissipate heat by ventilation than if they are located above it.

• Flat roof

N.B. in the case of installation on a flat roof, it is essential:

- To check the state of the roof and roof coverings (mainly weather tightness) in advance;
- To check that the existing structure or structural frame can support the overload associated with the collectors (80 kg to 100 kg per m² of collector) and their ballast.

On flat roofs, panels are generally laid on a metal or plastic structure. This allows an angle of slope to be obtained that will optimise the efficiency of the surface used, while ensuring ventilation to the back of the panel.

Some types of thin-film cells have also been produced. They allow direct integration into the weatherproofing of a flat roof and do not, thus, require the extra weight of a support. Though they are of interest both from the point of view of implementation (one material serving two functions) and that of budget, these cells give low performance and, in addition, must be installed according to the roof configuration, which will affect their efficiency.

• Facade

SUSTAINABLE REFURBISHMENT OF SCHOOL BUILDINGS

2. SERVICES AND ENERGY EFFICIENCY



It is possible to use photovoltaic panels as facade cladding. This type of configuration entails a major loss of efficiency due to reduced exposure to solar radiation (30% less than under optimal conditions). As with a sloping roof, modules can be integrated into or overlaid upon the structure.



Comment:

For school buildings under refurbishment, the surfaces of roofs or of fixed solar protection will be preferred, because children do not come into direct contact with these surfaces, which are better protected against impact, shocks or any vandalism.

• Solar protection

Cells can also be installed on fixed solar protection.

2.8.6.2. *Choice of panels and connection*

The choice of panel depends above all on the type of cell of which it is composed.

It is important to recall here that all technologies, whatever their provenance, are subject to tests under Standard Test Conditions (STC) specified in the European standards. This enables easy comparison between technologies according to their peak power.

The choice of panel often depends on two factors: its efficiency and the financial aspect. The more efficient a cell is, the more expensive it is and the greater the surface yield (kWh/m²).

In general, the type of cell used for the panel will be chosen according to available surface, output wanted and cost.

Aesthetics and the type of fixing can also influence the choice of panel.

with regard to connection, one would endeavour, as far as possible, to connect in series the maximum number of panels with identical specifications (strings). Care will also be taken to limit the length of and carefully design the cabling between panels. Correct specification of cable diameter allows avoidance of excessive heating and, thereby, unnecessary conduction losses.

2.8.6.3. *Choice of inverter*

The inverter is a very important component of the installation. Its specifications will naturally be determined according to the field of the collector in question.

Each inverter actually has specific operating ranges, which absolutely must correspond to the characteristics of the direct current generated by the panels.

The choice and design specification of the inverter will take account of:

- the maximum possible power generated by the panels (peak power is generally used (STC) reduced by 5% to 15%);
- minimum and maximum voltages (the voltage generated in an open circuit at -10°C is generally used as the low voltage and the MPP voltage at 70°C is generally used as the high voltage).
- maximum amperage

According to the size of the system, it may be necessary to reduce the number of inverters. In general, for systems larger than 5 kWc capacity, a second inverter can be provided.

SUSTAINABLE REFURBISHMENT OF SCHOOL BUILDINGS

2. SERVICES AND ENERGY EFFICIENCY



2.8.6.4. *Upkeep and maintenance*

There is little maintenance of a photovoltaic system. Occasional cleaning is still recommended.

Nonetheless, frequency of cleaning can be influenced by many surrounding factors: slope, location close to woodland, pollution etc. One of the advantages of this technology is that output can easily be measured, by means of installed meters. This allows rapid detection of abnormal operation of the system.

A sun tracker, on the other hand, requires more maintenance (motors etc.).

A photovoltaic system is a long-term investment, since its service life is generally greater than 25 years and can even be as much as 40 years. The manufacturers themselves generally guarantee that after 20 to 25 years the panel will still achieve 80% of its initial peak power.

An inverter, by contrast, has a more limited service life (between 10 and 15 years).

2.8.6.5. *Photovoltaic systems and grey energy (source: IEA-PVPS Task 10, EPIA European Photovoltaic Technology Platform)*

A study, carried out by Hespul with particular support from ADEME and the IEA, on the environmental impact of photovoltaic energy in the OECD countries, shows that, in Belgium, it will take about 3 years for a roof-mounted system to produce the energy required to manufacture it. This period is called the energy payback time.

For a facade-mounted system, it is estimated at 4.7 years. If one estimates the service life of an installation as 30 years, this means that it will produce 8.4 times as much energy as was required for its manufacture. This factor, known as the energy payback factor is 5.4 for facade-mounted systems.

Over its service life, a roof-mounted 1 kWc photovoltaic system will save the production of up to 8.5 tonnes of CO₂ (6.2 tonnes for facade-mounted systems).

2.8.6.6. *IEA Task 47 - Exemplary refurbishment projects with integration of PV panels*

Several renovation projects included in exemplary projects of the subtask A have integrated photovoltaic panels on roof or on façade (see subtask A). These include:

- Administration building Bruck/Mur - Austria (140 m² on the roof)
- TU Vienna Plus Energy - Austria (2246 m² on façades)
- School in Schwanenstadt - Austria (68 m² on the roof)
- Rockwool International Office Building - Hedehusene, Denmark (170 m² on the roof)
- Schüco Italian Headquarter - Italy (4550 m² on the roof)
- School Renovation - Cesena, Italy (pv panels on the roof)
- Boligselskabet Sjaelland Office Building - Denmark (130 m² on south façade)

SUSTAINABLE REFURBISHMENT OF SCHOOL BUILDINGS

2. SERVICES AND ENERGY EFFICIENCY



2.9. Heating recovery on ventilation system



If a building is well insulated and airtight, there will be little heat loss via the envelope and by infiltration. Heat loss via ventilation thus will account for a higher proportion. Mechanical heat recovery ventilation, fitted with a heat exchanger/heat recovery exchanger, considerably reduces such heat loss.

Ventilation fresh air, after being brought to the building's indoor comfort temperature, is then discharged to the outside with a higher energy level than the outside air being brought in. This is called enthalpy (heat content) greater than the outside air.

The intention is to transfer that heat from the extracted air to the incoming air.

In premises with high occupancy levels, such as classrooms, the amount of fresh air intake required may cause some thermal discomfort when the outdoor temperature is low.

Ideally, to avoid the sensation of a cold draught, the fresh air supplied should be preheated to a prescribed minimum temperature, which must be adjusted according to free heat gains.

There are various means of preheating fresh air, and heat recovery from extracted air may be a very worthwhile solution from the point of view of energy efficiency. It allows recovery of 50% to 85% of heat from extracted air (according to the type of heat exchanger selected). It must also be taken into account that the heat recovery system cannot on its own take up the preheating requirement in full because:

- In winter the temperature of the incoming fresh air can be inadequate. If 50% of discharged energy is recovered, the temperature gain, where the outdoor temperature is -10°C , will only be 5°C (given an exhaust air temperature of 20°C);
- When is very cold, discharged air in giving up its heat risks cooling to below 0°C , which entails the risk of frost on the heat exchange coil. To avoid this, the heat exchanger needs to be regulated, slowing the rate of exchange when the discharge air temperature drops too low, i.e. in very cold conditions and, thus, when there is the greatest need for preheating.

Therefore, most of the time the heat exchanger must be supplemented by a traditional preheating coil.

Even if their heat exchanger is not always cost-effective in accountancy terms, which demand a three-year return period, it still never represents an expense, since it still recovers its cost during its service life through the energy savings produced. We should, therefore, invest in technology rather than in fuel.

2.9.1. Principles

The heat recovery exchanger is fitted with a heat exchanger, enabling heat transfer. Stale air and fresh air from outdoors pass through this heat exchanger. The heat from extracted stale air is used to preheat intake air from outdoors. Only heat is transferred;

There is no contact between the two airflows.

This thermal exchange considerably reduces the energy consumption required to heat the fresh air from outdoors to a comfortable temperature for impulsion. In fact, a heat recovery exchanger can recover between 70% and 80% (even 90% to 95% for the most efficient types) of the heat from stale air and transfer it to the incoming flow of fresh air.

For refurbishment, installation of a heat recovery exchanger on the air extract first involves a double flow ventilation system where the extract fan is located close in the proximity of the supply air fan.

E.g.

For a heat exchanger with a thermal efficiency of 80%: if the air temperature is 0°C outdoors and 20°C indoors, after passing through the heat exchanger the supply air temperature is 16°C , with no heating input required.

SUSTAINABLE REFURBISHMENT OF SCHOOL BUILDINGS

2. SERVICES AND ENERGY EFFICIENCY

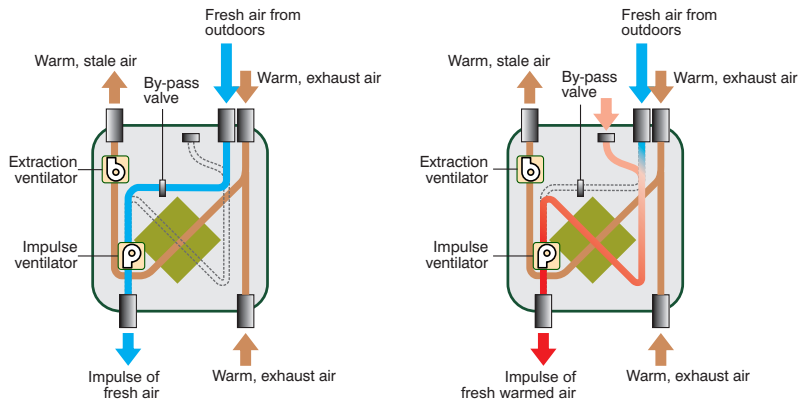

2.9.2. Heat recovery exchanger

2.9.2.1. Types of heat exchanger

There are four types of heat exchanger:

→ Heat pipes

The heat pipe is a heat superconductor operating in a closed cycle using evaporation– condensation, with liquid returned either by gravity or capillarity. Its usefulness is a result of the very high amount of latent heat from phase transition compared to specific heat. It comprises a hermetically sealed vessel containing a refrigerant fluid. The choice of heat transfer fluid is based on the anticipated operating temperature.

The flow of hot air through the lower part of the tube transfers its heat to the liquid, vaporising it. The vapour produced rises to the upper part of the tube where it comes into contact with cold air. The vapour then condenses on the internal surface of the tube, releasing its heat of condensation, and then is returned by gravity to the lower part of the tube for a fresh cycle.

There are still many heat pipes operating with chlorofluorocarbons (CFC) refrigerant fluids, now prohibited in new equipment.

The vertical arrangement is characteristic of the gravity type. There are also horizontal tubes where circulation occurs by capillarity. The latter system is reversible and can thus operate in summer. This type of heat exchanger is characterised by its low weight, absence of moving parts and reduced bulk. The exhaust and intake air pipes must, however, be close together.

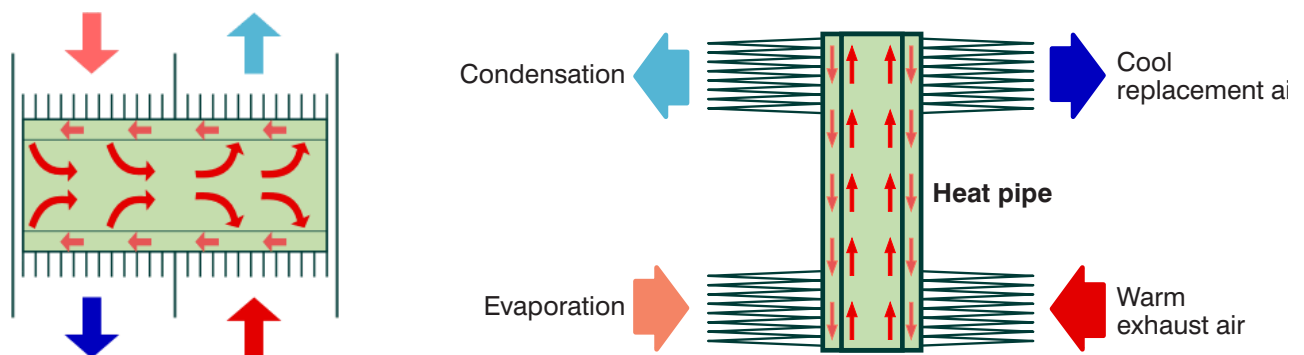

→ Plate heat exchangers

This type of heat exchanger is made up of thin aluminium or plastic plates, tubes or honeycomb-type corrugated plates, which separate the air channels. The material used for the manufacture of the plates varies: glass (not vulnerable to corrosion, but heavy and fragile), aluminium, stainless steel or synthetic materials. The plates are assembled by bonding or welding and placed in a rigid frame. The thickness of a plate generally varies between 0.1 mm and 0.8 mm and the gap between the plates is very small, between 5 mm and 10 mm, and flows are generally crossed.

In order to maximise exchange by convection, the plates may be corrugated, thus creating turbulence.

SUSTAINABLE REFURBISHMENT OF SCHOOL BUILDINGS

2. SERVICES AND ENERGY EFFICIENCY



Multiple options can be obtained by varying the size of plates and their number. It is also possible to:

- Increase the length of the heat exchanger, which, rather than a classic exchange by crossed currents, allows a mixed exchange with crossed currents and counter currents. This is called a double-plate heat exchanger.
- Assemble two heat exchangers in series with them operating, here too, by crossed current and counter current. If the heat exchangers are mounted in series, air channel flows will be such that the connections for both fresh air and exhaust air will be at the same level, which is always to be preferred.

To prevent overheating, heat recovery may be interrupted in summer or mid-season: a bypass will need to be provided. When the surfaces of the heat exchanger are cold enough (temperature below that of the dew point of extracted air), water vapour in the extracted air is cooled and condenses, which has the effect of increasing heat transfer. To eliminate condensation, the plates are often installed vertically. Units must then overlap and location constraints occur. With very low external temperatures, condensates may even freeze. To avoid problems of freezing and overheating, a means of regulation should be provided.

Similarly, given the risk posed by dirt, filters should be provided both on the fresh air channel and on the exhaust air channel.

If the system is dirty, this can cause not only a reduction in heat transfer, but also a change in the type of airflow. Therefore, regular maintenance of the heat exchanger should be provided for.

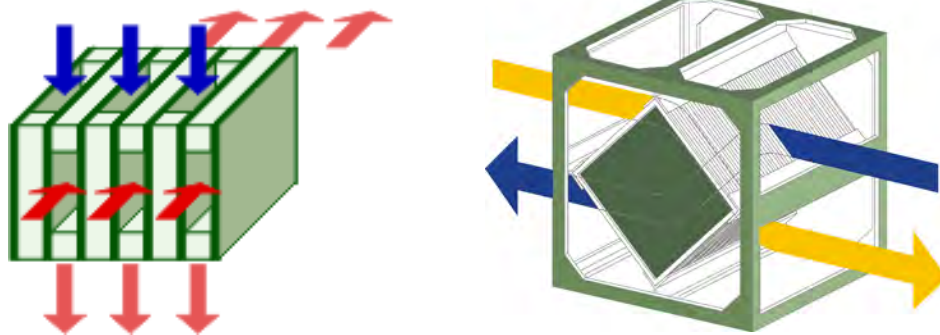

→ **Water-glycol solution heat exchangers** (picture below on the left side)

Water/glycol solution heat exchangers are made up of two batteries, usually made of copper tubes and aluminium fins (possibly copper/copper or entirely of galvanised steel), one placed in the extract unit and the other in the supply air impeller unit.

The distance between fins is 1.6 mm to 6 mm which, given the usual length of heat exchangers, renders a ClassG3 filter necessary for both intake and exhaust air; this is installed in each case upstream of the heat exchanger.

Given the bulk, not only of each heat exchanger, but also of the filter and transition pieces (boots) between the heat exchanger and air ducts both up- and down-stream, as well as the space required for changing the filter and cleaning the heat exchanger, a space 3.5 m to 4 m long is required. Sometimes it is realised too late that this space is not available for the installation, which is why it is essential to pay prior attention to this. In addition, it is always sensible to provide for thermal insulation of the connections to air ducts.

→ **Accumulator heat exchangers** (picture below on the right side)

The general principle of accumulator heat exchangers, otherwise known as regenerative heat exchangers is to recover heat contained in exhaust air by making this air pass over an accumulator material. This accumulator material is then subjected to the flow of fresh air to which it transfers its heat. The accumulator material might be impregnated with a hygro-

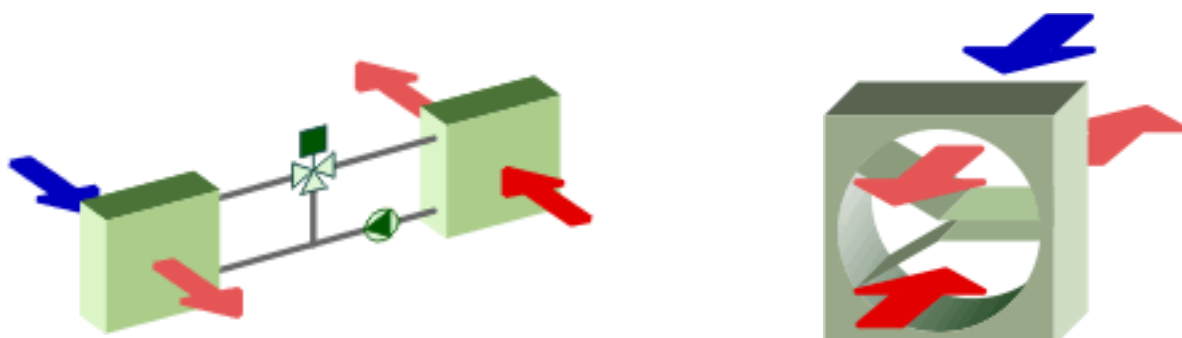

SUSTAINABLE REFURBISHMENT OF SCHOOL BUILDINGS

2. SERVICES AND ENERGY EFFICIENCY



scopic product so as to enable exchange of both sensible heat and humidity. There are several types of heat exchanger applying this technique.

2.9.2.2. Characteristics of each type

Criteria	Loop filled with glycol solution	Plate heat exchanger	Heat pipe	Accumulator heat exchangers
Need to place air ducts side-by-side	NO	YES	YES	YES
Possible to exchange humidity	NO	NO	NO	YES
Moving parts (risk of breakdown)	YES	NO	NO	YES
Output in sensible heat				
Specific bulk In m for 10,000 m ³ /h				
Danger of freezing	YES	YES	YES	NO
Mixing of fresh and stale air	NO	NO	NO	YES
Typical loss of charge In Pa	150 - 250	120 - 250	180	150

Source: Website Energie Plus - <http://www.energieplus-lesite.be>

2.9.2.3. Performance and energy gain

The efficiency of a heat recovery ventilation system depends first of all upon the airtightness of the building. For a building that is not very airtight, the system is partially short-circuited by various leaks: part of the heated air leaks to the exterior without passing through the heat exchanger and some fresh air enters the building directly without being preheated in the heat exchanger.

To assure efficiency of a heat recovery ventilation system, good airtightness is essential. This airtightness must achieve at least $\eta_{50} \leq 1 \text{ h}^{-1}$.

Otherwise, the efficiency of the system is determined by the thermal performance of the heat exchanger, the efficiency of the fans, the loss of pressure to be made up (dependent upon the design of the distribution network).

Consequently, it is important to require that, in the context of the refurbishment energy efficiency measures, the heat exchanger selected should comply with certain criteria including a minimum thermal performance and a specified power for the fans.

Use of a heat exchanger giving a temperature recovery performance of more than 90% and equipped with a regulating system enabling heat recovery during the whole heating season (management of defrosting), enables a saving in investment on post-heating units and on the installation of heat generation equipment.

2.9.3. Installation in school refurbishment

There are two possible pre-existing conditions for school buildings being refurbished:

2.9.3.1. The building may have a mechanical heat recovery ventilation system without heat recovery exchanger

In an existing installation, the short-term cost effectiveness of installing a heat exchanger may be problematic, given the high costs of its purchase and installation, the operating costs in terms of energy consumption of pumps, ventilators and accessory equipment, together with equipment maintenance costs. So far as technically possible for refurbishment, adopting a heat recovery system for exhaust air is especially useful if there are:

- high air flow rates (more than 10,000 m³/h);
- permanent use of the ventilation system;
- high thermal requirements;

SUSTAINABLE REFURBISHMENT OF SCHOOL BUILDINGS

2. SERVICES AND ENERGY EFFICIENCY



- an over-specified fan and fan motor on the output, which can avoid the need to replace sheaves and motor to maintain the prescribed flow rates.

If the air-handling unit is not replaced, the only realistic solution requiring a minimum of technical work is that of a glycol solution heat exchanger. It also has the advantage of not requiring the air intakes and outlets to be close together. It is, however, sometimes necessary to adapt the section of ducting at the coils to possibly adjust the air speed.

If the air-handling unit is completely replaced, any type of heat exchanger can be installed (as for a new building).

Comment:

The heat recovery exchanger does, however, entail:

- An additional investment during refurbishment;
- More space taken up with building services equipment;
- Increased loss of pressure to the system.

2.9.3.1. *The building may have no ventilation system*

The installation of a mechanical heat recovery ventilation system and its network of air ducts has an inevitable impact upon spatial organisation and the siting of building services areas and service ducts. Quite a lot of space is taken up by ducts and pipework both in the vicinity of the heat exchanger and service ducts. It may be necessary to install a false ceiling in circulation areas, entrance halls and sanitary facilities.

Good network design is also indispensable in assuring both heat exchanger efficiency and acoustic comfort for teachers and pupils. This means that the installation of a ventilation system must be considered very early in a refurbishment scheme.

Two solutions can be considered:

→ Installation of decentralised units, each one serving particular premises

In this case, it can be useful to integrate the ventilation unit into a building services duct within the facade insulation, if this needs to be improved or reinstalled (prefabricated facade component with integrated building services – see ECBCS Annex 50 «Prefabricated Systems for Low Energy Renovation of Residential Buildings»).

Such decentralised units require greater financial investment, but have the advantage of offering greater flexibility in terms of use, management and maintenance.

→ Installation of a centralised system within the building

In this case, some aspects need to be studied in depth: the installation's design specification, the choice of heat exchanger and fans and the design of the interior network.

Heat exchanger

- The heat exchanger – as well as the fans – must be sited centrally so as to limit the length of ducts, close to fresh air intake and stale air exhaust vents and in premises that will limit diffusion of noise nuisance.
- The heat exchanger must be easily accessed for maintenance and filter replacement;
- Condensate drainage and an electrical supply must be provided;
- Certain distance must be allowed between the heat exchanger and the ducting outlet (outside the premises), in order to be able to install silencers if necessary;
- The heat exchanger should always be fitted with a bypass so that air at the outdoor temperature can be blown in when desirable (e.g. in the event of overheating);
- A defrosting system must be provided in case of excessively low outdoor temperatures.

2.9.4. Maintenance

Maintenance of a heat recovery system is an important factor contributing to achievement of the forecast energy efficiency gains over the equipment's service life. Inter-alia, keeping the heat exchanger clean is a matter that should not be neglected. In fact, dirt on the heated exchange surfaces will have two damaging results for heat recovery: reduction of the heat exchange coefficient and reduced airflow.

Filter maintenance should be carried out between two and four times per year according to the size of the installation.

SUSTAINABLE REFURBISHMENT OF SCHOOL BUILDINGS

2. SERVICES AND ENERGY EFFICIENCY



2.10. Preheating / precooling of air by underground heat exchanger



The underground heat exchanger or earth pipe is a geothermal system that uses heat from the ground to preheat or pre-cool ventilation fresh air

While the temperature of outdoor air can vary in Europe between -20°C and $+40^{\circ}\text{C}$ throughout the year, the ground temperature at a depth of 2 metres remains stable, on average between 5°C and 15°C , according to the season. The principle is to use a fan to circulate ventilation fresh air through a buried pipe, before impelling it into the building:

- in winter, the air is heated while passing through the pipe and, consequently, less energy is required to heat it;
- in summer, the outdoor air is cooled using the coolness of the ground and, consequently, enables improved thermal comfort in the summer;

The underground heat exchanger gives a saving in the order of 20% to 25% of energy consumption linked to heating fresh air (5% to 10% of the total heating consumption) plus cooling during hot weather.

This technical facility can be worthwhile for new buildings, however, it is difficult to apply to school buildings in need of refurbishment.

In fact, major groundworks are required to install the ventilation pipes, often requiring large construction plant: mechanical excavator, lorries etc. Therefore, they are difficult to reconcile with the functioning of outdoor spaces and playgrounds (usually situated around school buildings), as well as with child safety. These works are also expensive, which often makes this type of installation not very cost efficient.

It should also be noted that when the earth pipe is combined with a heat exchanger and a dual-flow mechanical ventilation system, its efficiency becomes negligible as compared with that of the heat exchanger. Preference will, therefore, be given to the heat recovery exchanger.

For these various reasons, we will not pursue this theme in this publication. Nonetheless, we suggest a number of reference works:

- **Guide Bâtiment Durable**, Bruxelles Environnement, Bruxelles - <http://guidebatimentdurable.bruxellesenvironnement.be/fr/index?IDC=3>
- **Energie Plus website** - www.energieplus-lesite.be
- **Les puits canadiens / provençaux, guide d'information**, CETIAT (Centre techniques des industries aérodynamiques et thermiques, janvier 2008)

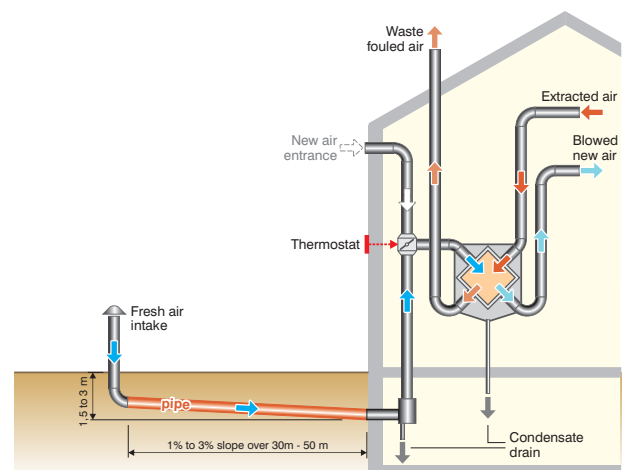
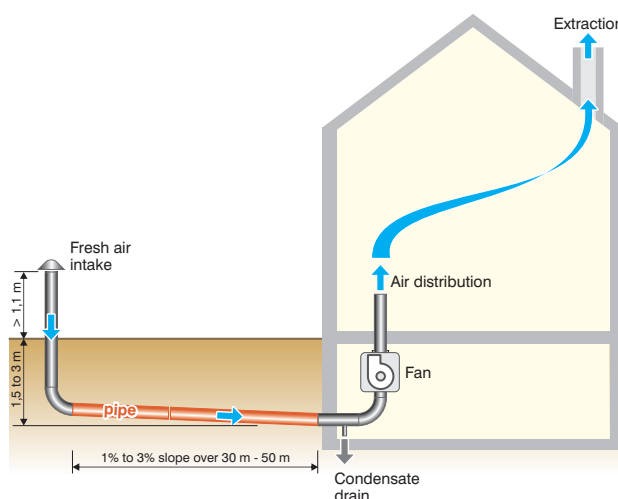

SUSTAINABLE REFURBISHMENT OF SCHOOL BUILDINGS

2. SERVICES AND ENERGY EFFICIENCY



2.11. Services and energy efficiency - Breeam assessment method

To assess the issue «Services and energy efficiency », BREEAM assessment method proposes various criteria mainly listed under the section «ENERGY» with a weighting of xx% in the evaluation:

- ENE 01: Reduction of emissions (see booklet section 1 «Comfort and quality of life»)
- ENE 02: Energy monitoring
- ENE 03: External lighting
- ENE 04: Low and zero carbon technologies
- ENE 07: Energy efficient laboratory systems

Therefore, an overview of these criteria is presented below.

For additional information : <http://www.breeam.org/page.jsp?id=381>

2.11.1. ENE 02 - Energy monitoring

This issue aims to recognise and encourage the installation of energy sub-metering that facilitates the monitoring of operational energy consumption. This issue is **mandatory** to achieve a minimum standard but for school building, only the first credit must be achieved.

Criteria	Number of credits	Explanation
Energy monitoring	1 credit	<p>The following major energy consuming systems (where present in the school building) are monitored using either a Building Energy Management System (BEMS) or separate accessible energy sub-meters with a pulsed output to enable future connection to a BEMS:</p> <ul style="list-style-type: none"> - Space Heating - Domestic Hot Water - Humidification - Cooling - Fans (major) - Lighting - Other major energy-consuming items where appropriate <p>The end energy consuming use is identifiable to the building user through labelling or data output.</p>

2.11.2. ENE 03 - External lighting

This issue aims to recognise and encourage the specification of energy-efficient light fittings for external areas of the development. This issue is not **mandatory** to achieve a minimum standard.

Criteria	Number of credits	Explanation																			
External lighting	1 credit	<p>All external fittings, where provided, within the construction zone meet the lighting requirements as given below:</p> <table border="1"> <thead> <tr> <th rowspan="2">External lighting location</th> <th colspan="2">Light fittings measured in lamp lumens/circuit Watt, when:</th> <th colspan="2">LED luminaires where the lamp is integral to the fitting measured in luminaire lumens/circuit Watt, when:</th> </tr> <tr> <th>Colour rendering index (Ra) ≥ 60</th> <th>Colour rendering index (Ra) < 60</th> <th>Colour rendering index (Ra) ≥ 60</th> <th>Colour rendering index (Ra) < 60</th> </tr> </thead> <tbody> <tr> <td>Building, access ways, pathways</td> <td>50</td> <td>60</td> <td>40</td> <td>50</td> </tr> <tr> <td>Car parking, associated roads, flood-lighting</td> <td>70</td> <td>80</td> <td>55</td> <td>60</td> </tr> </tbody> </table> <p>External light fittings are controlled through a time switch, or daylight sensor, to prevent operation during daylight hours. Daylight sensor override on a manually switched lighting circuit is acceptable</p>	External lighting location	Light fittings measured in lamp lumens/circuit Watt, when:		LED luminaires where the lamp is integral to the fitting measured in luminaire lumens/circuit Watt, when:		Colour rendering index (Ra) ≥ 60	Colour rendering index (Ra) < 60	Colour rendering index (Ra) ≥ 60	Colour rendering index (Ra) < 60	Building, access ways, pathways	50	60	40	50	Car parking, associated roads, flood-lighting	70	80	55	60
External lighting location	Light fittings measured in lamp lumens/circuit Watt, when:			LED luminaires where the lamp is integral to the fitting measured in luminaire lumens/circuit Watt, when:																	
	Colour rendering index (Ra) ≥ 60	Colour rendering index (Ra) < 60	Colour rendering index (Ra) ≥ 60	Colour rendering index (Ra) < 60																	
Building, access ways, pathways	50	60	40	50																	
Car parking, associated roads, flood-lighting	70	80	55	60																	

SUSTAINABLE REFURBISHMENT OF SCHOOL BUILDINGS

2. SERVICES AND ENERGY EFFICIENCY



2.11.3. ENE 04 - Low and zero carbon technologies

This issue aims to reduce carbon emissions and atmospheric pollution by encouraging local energy generation from renewable sources to supply a significant proportion of the energy demand. This issue is **mandatory** to achieve a minimum standard and provides a maximum of 5 credits. This issue is split into three parts:

Criteria	Number of credits	Explanation
Feasibility study	1 credit	<p>1. A feasibility study has been carried out by an energy specialist to establish the most appropriate local (on-site or near-site) low or zero carbon (LZC) energy source for the building/development.</p> <p>This study covers as a minimum:</p> <ul style="list-style-type: none"> - Energy generated from LZC energy source per year - Life cycle cost of the potential specification, accounting for payback - Local planning criteria, including land use and noise - Feasibility of exporting heat/electricity from the system - Any available grants - All technologies appropriate to the site and energy demand of the development - Reasons for excluding other technologies. - Where appropriate to the building type, connecting the proposed building to an existing local community CHP system or source of waste heat or power OR specifying a building/site CHP system or source of waste heat or power with the potential to export excess heat or power via a local community energy scheme. <p>2. A local LZC energy technology has been specified for the building/development in line with the recommendations of the above feasibility study.</p> <p>3. The feasibility study has been carried out at RIBA stage C (concept design) or equivalent procurement stage.</p> <p>or</p> <p>4. The organisation that occupies the building has in place a contract with an energy supplier to provide electricity for the assessed building/development from a 100% renewable energy source. This supply must be delivered by an accredited external renewable source. The contract must be valid for a minimum of 3 years from the date the assessed building becomes occupied.</p>
Low or zero carbon technology specification and installation	up to 4 credits	<p>Criteria 1 to 3 must be achieved.</p> <p>5. A local LZC energy technology has been installed in line with the recommendations of the feasibility study and this method of supply results in a reduction in regulated CO₂ emissions as follows:</p> <ul style="list-style-type: none"> - 2 credits : 10 % reduction in regulated CO₂ emissions - 3 credits: 20 % reduction in regulated CO₂ emissions - exemplary level : 30% reduction in regulated CO₂ emissions <p>or</p> <p>6. Where the feasibility study includes a Life Cycle Assessment of the carbon impact of the chosen LZC system(s), accounting for its embodied carbon emissions and operational carbon savings and emissions, and this method of supply results in a reduction in life cycle CO₂ emissions as follows:</p> <ul style="list-style-type: none"> - 3 credits : 10 % reduction in life cycle CO₂ emissions - 4 credits: 20 % reduction in life cycle CO₂ emissions - exemplary level : 30% reduction in life cycle CO₂ emissions <p>The LCA study must be completed in accordance with ISO 14044:2006 Environmental Management Life Cycle Assessment – Requirements and Guidelines</p> <p>7. The LCA must consider a 60 year period (a typical assumption for the life of a building) and any necessary replacements/maintenance requirements within this period</p>

SUSTAINABLE REFURBISHMENT OF SCHOOL BUILDINGS

2. SERVICES AND ENERGY EFFICIENCY



Free cooling	1 credit	<p>8. Where, regardless of the percentage reduction in the building's CO2 emissions from LZC sources and number of BREEAM credits achieved above, the building utilises ANY of the following free cooling strategies and the first credit within the BREEAM issue Hea 03 Thermal comfort has been achieved:</p> <ul style="list-style-type: none"> - Night-time cooling (requires fabric to have a high thermal mass) - Ground coupled air cooling - Displacement ventilation (not linked to any active cooling system) - Ground water cooling - Surface water cooling - Evaporative cooling, direct or indirect - Desiccant dehumidification and evaporative cooling, using waste heat - Absorption cooling, using waste heat. - The building does not require any form of cooling (i.e. naturally ventilated)
--------------	----------	--

2.11.4. ENE 07 - Energy efficient laboratory systems

This issue aims to recognise and encourage laboratory areas that are designed to minimise the CO2 emissions associated with their operational energy consumption. This issue is not **mandatory** to achieve a minimum standard .

Criteria	Number of credits	Explanation
Energy efficient laboratory systems	1 credit	<p>For school buildings:</p> <p>Recirculatory filtered fume cupboards (as oppose to ducted fume cupboards) are specified as the preferred option for the majority of applications</p> <p>If ducted fume cupboards are specified, the fume cupboards have a face velocity of less than or equal to 0.5 m/s .</p> <p>The specification of fume cupboards has been carried out in accordance with all relevant european guide- lines and recommendations.</p>

3. REDUCE RESOURCES CONSUMPTION



1.	Reducing drinking water consumption	231
1.1.	Water consumption in schools	232
1.2.	Raising users' awareness and changing behaviour	233
1.2.1.	Raising children's awareness about the necessity of drinking water and about water resources	233
1.2.2.	Encouraging the drinking of tap water	233
1.2.3.	Installation of drinking water fountains	233
1.2.4.	Careful choice of cleaning products	234
1.3.	Action to be taken for sustainable management of water on the site and in the building	234
1.4.	Rational use of water, designing or improving sanitary facilities to minimise consumption while maintaining water quality.	235
1.4.1.	Limiting water loss in the school: flushing out leaks	235
1.4.2.	Designing and installing a quality plumbing installation	235
1.4.3.	Installing water-efficient appliances and fittings	236
1.5.	Recovery and use of rain water	237
1.5.1.	Rainwater harvesting	237
1.5.2.	Rainwater filtering	239
1.5.3.	Rainwater storage (tank)	240

Picture: Catherine Massart

1.5.4.	Feed, distribution and hydrophore pump	242
1.5.5.	Rainwater in the school: inform and protect	244
2.	Replenishing water resources and reducing rainwater runoff	245
2.1.	Design concepts for integrated management of rainwater	245
2.2.	On-site water management (around the buildings)	246
2.2.1.	Useful indices	246
2.2.2.	Planting of the plot	247
2.2.3.	Selection of ground cover materials (adjacent areas, traffic and parking areas etc.)	247
2.3.	Rainwater retention and infiltration systems	247
2.3.1.	Swales	248
2.3.2.	Dry basin	249
2.3.3.	Soakaway	250
2.3.4.	Shafts	250
2.3.5.	Rainfall-retaining roofs	251
2.3.6.	Design principles	252
3.	Controlling consumption of natural resources	253
3.1.	Various available resources	254
3.1.1.	Non-energy natural resources	254
3.1.2.	Recycled resources	254
3.1.3.	Energy resources	254
3.1.4.	Resource availability	255
3.1.5.	Sustainable exploitation of timber resources – FSC and PEFC certification schemes	256
3.2.	The concept of grey energy	256
3.2.1.	Definition of grey energy	256
3.2.2.	Relationship between grey energy and operational energy	257
3.2.3.	Relationship between grey energy and service life	258
3.2.4.	Comment: fossil resources and raw materials	258
3.2.5.	Grey energy-saving	258
3.3.	Environmental impacts of buildings materials	259
3.3.1.	Atmospheric pollution	259
3.3.2.	Impact on the landscape and biodiversity	262
3.3.3.	Waste production	262
3.3.4.	Impact on health	263
3.4.	Materials selection: goals and action during refurbishment	264
3.5.	Guiding principles for the selection of materials and construction methods	264
3.5.1.	Rationalising the use of construction materials during refurbishment	265
3.5.2.	Optimising maintenance and maintaining performance during the building's service life.	266
3.5.3.	Optimising the end of refurbishment life: facilitating deconstruction, encouraging sorting and re-use.	266
3.5.4.	Limiting depletion of resources by employing three courses of action: economy of materials, selection and sourcing of materials and re-use of materials.	267

3.6.	Environmental impact, ecological audit and environmental assessment tools	267
3.6.1.	Eco-audit and life-cycle analysis	268
3.6.2.	Environmental assessment tools	268
4.	Reduce non energy resources consumption - Breeam assessment method	273
4.1.	WAT 01 - Water Consumption	273
4.2.	WAT 02 - Water Monitoring	273
4.3.	WAT 03 - Water leak detection and prevention	274
4.4.	MAT 01 - Life cycle impact	275
4.5.	MAT 02 - Hard landscaping and boundary protection	275
4.6.	MAT 03 - Responsible sourcing of materials	275
4.7.	MAT 04 - Insulation	276
4.8.	MAT 05 - Designing for robustness	276
4.9.	POL 03 - Surface water run off	276

SUSTAINABLE REFURBISHMENT OF SCHOOL BUILDINGS

3. REDUCE NON ENERGY RESOURCES CONSUMPTION



3.1. Reducing drinking water consumption



Water, as a resource, is a major issue for sustainable development, because it is intimately linked to the survival of every living thing on Earth. The WHO and UNICEF defined having reasonable access to water as meaning that «it is possible to reliably obtain at least 20 litres per member of a household per day» and that «the source is less than 1 km away from its place of use» (WHO, 2008; WHO & UNICEF, 2003).

This issue affects all of the world's economic sectors: food, health, agriculture and industry, including the construction industry. But this issue also and substantially affects the balance between ecosystems and biodiversity on the one hand, and the geopolitical balance between countries on the other hand.

E.g.

- Billions of people, mainly in developing countries, draw their water directly from rivers, lakes, springs and wetlands;
- Freshwater fish may supply up to 70% of animal protein in many developing countries.

Today, «water is a global resource in crisis»¹. This crisis is simultaneously caused by natural meteorological or hydrological disasters and by the depletion of water resources consequent upon population growth and human activity, in particular the consumption of fossil fuels, global warming and also poor land management.

The challenge posed by water resources is to know how to manage them over their whole cycle, at both a local and a global level.

→ Accessibility and availability of fresh water worldwide and in Europe

Water is a resource that is unequally distributed on the Earth's surface, with regard to its quality, quantity and accessibility, by reason of the climate, landscape, geology and the economic and technological means of each country.

Taking UNESCO's figures, in 1995, approximately 1.8 billion people were living in areas subject to severe water stress i.e. without access to sufficient quality and quantity of water. This figure continues to increase and the United Nations forecasters anticipate that, in 2025, half of the population will lack drinking water if nothing is done to halt the process.

Water shortage or «water stress» designates the annual availability of water per head of population for a country or a region. When a country or region reaches the stage of water stress, this signifies that it has reached the limit of its capacity to meet ecosystem and human needs. This limit is between 1,700 m³ and 2,500 m³ per person per year.

Looking at the two maps (next page), one notes that many countries have already reached that limit, whether because of low water supply or replenishment, or because of high population density, or a combination of the two.

One also notes that many European countries have only between 1,700 m³ and 5,000 m³ of renewable fresh water per head of population per year and are at, or past, the water stress limit. This phenomenon is partially explained by population density and the large area of impermeable surfaces. Having become aware of this situation, it becomes urgent to manage our water resources in a considerate and rational manner.

→ Exploitation of water resources

Over the course of the 20th century, the world's population grew from 1.7 billion persons in 1900 to over 6 billion in the year 2000. During this period, the demand for water increased sixfold².

In 1950, world water resources were estimated at 17,000 m³ per person per year. Due to high population growth together with industrialisation, urbanisation and agricultural intensification, renewable and available water resources were no more than 7,500 m³ per person per year in 1995.

It is liable to fall to less than 5,100 m³ in 2025. (Source: Eurostat 2002). In the countries of the European Union, average water resources amount to 7000 m³ per person per year. (Source: Eurostat 2002).

This major increase in water consumption is not only due to population growth, but also to the increase in average demand for water per person, which is a consequence of greater ease of access to drinking water and to industrial and agricultural development.

1 Source: [MAHAUT 2009]

2 Source: «Dossier eau» available at <http://www.cnrs.fr/cw/dossiers/douseau>

SUSTAINABLE REFURBISHMENT OF SCHOOL BUILDINGS

3. REDUCE NON ENERGY RESOURCES CONSUMPTION

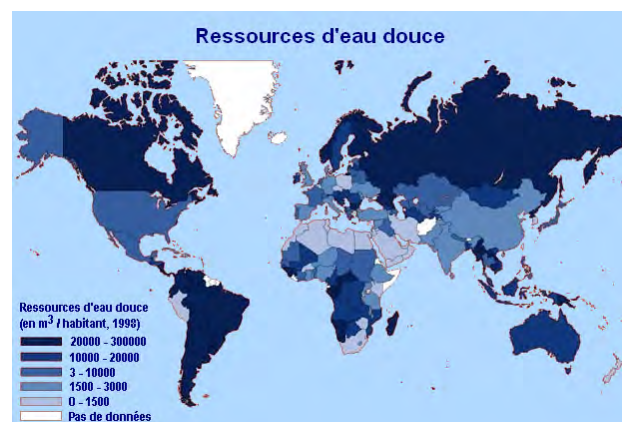
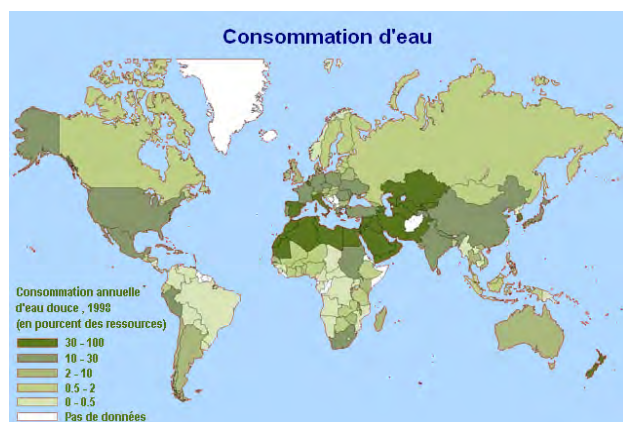

Today, worldwide, people draw nearly 5,000 km³ of fresh water per year for their various purposes.

Water is, thus, at the heart of most human activity. Agricultural activities, in particular irrigation and animal husbandry, are the world's main consumers of water. They total approximately 70% of world consumption. Water is also used in numerous industrial processes, e.g. in the chemical and metallurgy sectors, and in the paper and cardboard industry.

Finally, water is consumed for communal domestic purposes (schools, hospitals, road cleaning etc.) and by households (hygiene, cleaning, food etc.).

For our basic needs (drinking, washing and cooking), we need five litres per person per day. For a reasonable quality of life and good public health, we need up to 80 litres per person per day for laundry and waste removal.

Yet, average domestic consumption of water in Europe is between 150 litres and 200 litres per day, according to region and location. Most of this consumption is for hygiene and supply to sanitary facilities.

→ Pollution of water resources

Water pollution remains a disturbing issue. Pesticides, nitrates, nitrites, organic materials and phosphates are some of the pollutants found in underground and surface water. If the quality of underground bodies of water is still good in most cases, that of surface water remains a problem in several areas.

A suitable supply of good quality water is vital for a good quality of life and necessary for economic and social progress. Two tasks must be undertaken: we must learn to economise on the water and we must manage our available resources in a more sustainable way.

These ideas need to be acquired by children at the earliest age.

Responsible use of water is the greater part of preventive measures, both for reducing consumption and reducing the pollution of wastewater that we dispose of.

3.1.1 Water consumption in schools

The Court of Auditors (Belgium) surveyed 56 of the French Community's autonomous elementary schools, which offer both infant and primary education. These establishments spend 202 euros on energy consumption and 18.38 euros on water per pupil per year. With regard to gas and fuel oil, the average cost is 140 euros per pupil, but the Court noted that six schools need to spend more than three times this and four others less than half. Annual electricity consumption was 59.92 euros per pupil. Three establishments spent less than half, while five spent more than three times this amount. The Court, consequently, points to an annual consumption per pupil that can vary between 10.60 euros and 455.80 euros.

With regard to water consumption, the Court highlighted «significant variations». One establishment's consumption (141.60 euros per pupil) is eight times greater than the average. Seven schools also spent less than 10 euros per pupil for water consumption while, for five others, the expenditure was three times greater than the average.

Source: <http://www.lalibre.be/economie/actualite/article/719503/ecoles-des-disparites-fortes-dans-la-consommation-d-energie.html>

SUSTAINABLE REFURBISHMENT OF SCHOOL BUILDINGS

3. REDUCE NON ENERGY RESOURCES CONSUMPTION



3.1.2. Raising users' awareness and changing behaviour

Domestic water consumption has increased considerably over the past century. In 1900, each person consumed between 15 and 20 litres per day for all their needs. Today, domestic consumption reaches 150 to 200 litres per day, according to region and situation. The greater part of this consumption is distributed as follows:

- Hygiene (40%),
- Supply to sanitary facilities (25%),
- Cleaning and laundry (30%),
- Food (5%).

Therefore, 55% of our needs do not require water of drinking standard. Some public institutions, such as hospitals, sports halls, swimming pools etc., also consume very large quantities of drinking water.

With regard to schools, it is essential to raise the awareness of both teachers and children about their water consumption, about water pollution and the rational use of this resource that is vital to our life on Earth.

A policy for rational use of drinking water must be set up by means of simple actions and by the installation of water-saving equipment.



Source: cieau.com



Source: autosanit.com

3.1.2.1. Raising children's awareness about the necessity of drinking water and about water resources

This awareness raising can be carried out through various subject classes and can, at overall level of the school, become the theme for a school year.

Answers can be given to various questions:

- How does tap water affect health?
- Where does our drinking water come from?
- What is the water cycle?
- Bottled or canned drinks: how do they affect environment and health?

This awareness raising can also occur through an evaluation and analysis of what happens within the school in terms of water consumption and waste produced in connection with consumption of drinks.

3.1.2.2. Encouraging the drinking of tap water

Many children arrive in school with plastic water bottles, Tetra packs of fruit juice etc. in their school bags. A policy of rational drinking water use and a policy of waste reduction require getting rid of vending machines for sugary drinks and prioritising the use of tap water in school by encouraging:

- children to use a flask;
- teachers to give access to the classroom sink so that children can refresh themselves at snack time or when returning from breaks. Each child can have their own reusable glass that they leave in the classroom.

3.1.2.3. Installation of drinking water fountains (hygiene concern)

Drinking water fountains can also be installed in the school. These are directly connected to the water supply.

Preference should be given to vertical jet drinking fountains. By pressing a button on the edge of the steel basin, a domed jet of water is emitted, allowing the child to drink while avoiding direct contact with the mechanism. This is a hygienic system, which allows pupils to be provided with a high-quality drink, without using unnecessary cups.

SUSTAINABLE REFURBISHMENT OF SCHOOL BUILDINGS

3. REDUCE NON ENERGY RESOURCES CONSUMPTION



3.1.2.4. Careful choice of cleaning products

Limiting a school's water consumption is a vital policy for good citizenship, but it is just as important to have a concern for the quality of waste water:

- through not throwing just anything down sinks, toilets and drains: e.g. food remains, packaging, handicraft products, leftover paint etc.;
- through avoiding overuse of detergents. In fact, though these products are for cleaning, they also pollute the environment. Their consumption should, thus, be limited by not exceeding the recommended quantities and giving preference to environmentally-friendly products with simple ingredients.

3.1.3. Action to be taken for sustainable management of water on the site and in the building

Contrary to unlimited/irresponsible consumption of district/municipal/city/tap water and sewage, if the project is to commit itself to the water cycle there is a need for more thoughtful and considerate site-level management that also takes into account the question of cleaning and maintenance. This comprises four main, interconnected elements:

→ Water-saving

Water-saving appliances entail only a slightly higher investment, which protects user-comfort and reduces consumption costs.

→ Rainwater harvesting

Use of rainwater for purposes that do not require drinking water can prove to be an ecologically sound solution. According to the project's local conditions, it can also lead to savings. However, this needs to be looked at taking into account installation and renewal costs of the storage tank and of duplicate pipework.

→ On-site rainwater management

Unlike traditional drainage systems that seek to speedily drain water downstream into the drainage system, on-site rainwater management systems aim to restore the water to the natural environment as far upstream as possible. The following are preferred, in order of priority:

- Evaporation, evapotranspiration and infiltration directly into the ground if conditions allow;
- Storage, followed by infiltration or channelling for a purpose that can be achieved with rainwater;
- Storage followed by release at a controlled flow rate.

→ Recycling wastewater (grey water and sewage)

Consideration can be given to local recycling of wastewater (grey water and/or sewage). Wastewater can be easily treated so that it can be reused instead of being directly discharged into the sewers. In densely-populated urban areas, the quantity of water collected from roofs is often insufficient to supply all needs suited to water of that quality. Rather than making up the shortfall with mains water, it is possible to re-use recycled wastewater, in particular for cleaning buildings, watering outdoor areas and supplying sanitary facilities.

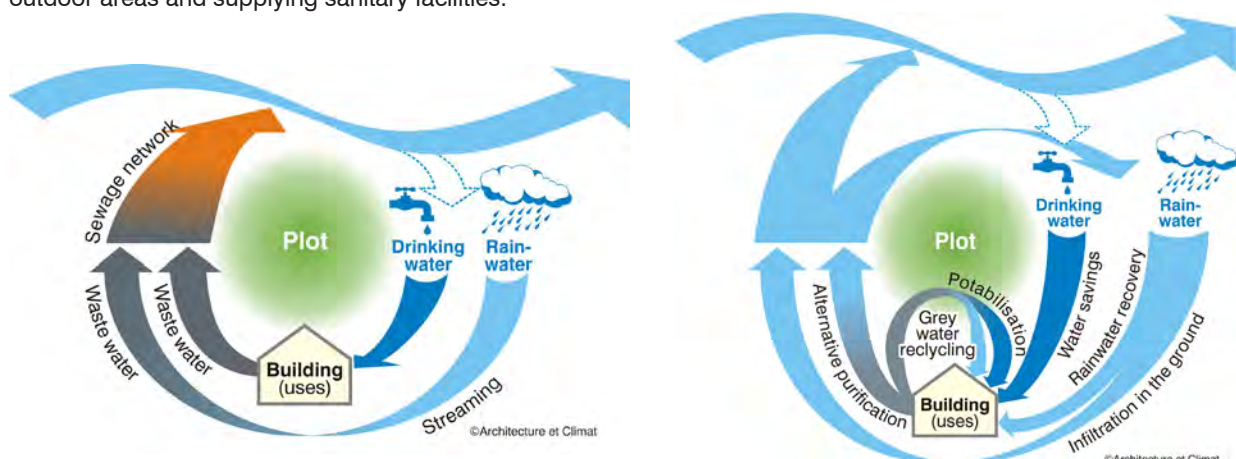



3.1.4. Rational use of water, designing or improving sanitary facilities to minimise consumption while maintaining water quality.

Toilets, showers, taps, water pipes and domestic appliances are some of the installations that suck up water and need to be tackled. This needs to be addressed just as much on an individual level as in all the institutions or buildings to which the public or children have access, such as schools, swimming pools, sports halls, libraries etc.

3.1.4.1. Limiting water loss in the school: flushing out leaks

Leaking taps and trickling toilet flush tanks can be a heavy burden to a school budget.

Water leaks	Quantity wasted - average data
Dripping	4 liters per hour
Fine trickle	16 liters per hour
Trickle	63 liters per hour
WC cistern leak	25 liters per hour

Source: Information sheet «Faire un usage rationnel de l'eau» Guide pour la construction et rénovation de petits immeubles, IBGE [Brussels Institute for the Management of the Environment], 2007.

Therefore, it is vital to be able to locate a water leak on the school water supply pipework as quickly as possible.

In order to be able to rapidly detect a water leak it is necessary to:

- during refurbishment, check the condition of the water supply installation with regard to water tightness during the refurbishment;
- have a good knowledge of the water supply installation as it was actually implemented on-site (based upon drawings).

→ Checking water supply information → on-site

Before the start of refurbishment works and at completion, the contractor shall perform a check of the installation by pressurising it in order to:

- detect any leaks on the existing system before refurbishment;
- check the repair of any leaks;
- check for defective work (new system or extension of existing system) that could give rise to leaks.

→ Knowledge of the water supply installation

A good knowledge of the water supply installation is essential for the management, maintenance and monitoring of that installation.

To that end, designers shall ensure they obtain a drawing of the water supply and drainage installation as installed during construction or as constructed/modified on the refurbishment site.

This plan must give the following information:

- Location of supply and drainage pipes;
- Numbered and labelled shut-off valves at the bottom of rise and down pipes;
- The various inspection covers;
- The various connections.

→ Checking, upkeep and maintenance of installations

In the context of sustainable management of a school's facilities, it is essential that the whole of the water supply installation and appliances are checked very regularly. When a problem is detected (leak, faulty appliance etc.) action must be taken quickly to carry out repair or replacement in order to prevent water being wasted.

3.1.4.2. Designing and installing a quality plumbing installation

This is about assuring the quality of water in the internal installation, from the meter to the draw-off points, and protecting the public water mains.

A well-designed installation is one that:

SUSTAINABLE REFURBISHMENT OF SCHOOL BUILDINGS

3. REDUCE NON ENERGY RESOURCES CONSUMPTION



- has the shortest possible supply pipework;
- includes the minimum number of vulnerable elements such as elbows, joints etc.;
- avoids dead legs, corrosion due to the presence of the different metals, contamination of water by problematic materials such as a lead and contamination by non-potable water (rainwater etc.);
- is identifiable and accessible in order to facilitate its management, maintenance and monitoring. Any problems should be easily identified and repair and other works should not entail demolition;
- is regularly maintained.

3.1.4.3. Installing water-efficient appliances and fittings

Usually this is about devices that entail only minimal or nil extra cost, listed below in the four groups:

- The water supply network and its accessories:
Pressure reducers, distance between draw-off points and sanitary hot water reservoirs, leak detector etc.
- Tapware, valves and accessories
Flow limiters, automatic taps etc.
- Water-efficient appliances for equivalent use:
High-efficiency or pressure-assist flush toilets, waterless urinals etc.
- Sanitary appliances encouraging economical use
Dishwashers in canteens and refectories, washing machines in nurseries etc.

Water-saving devices		Compatibility with existing installation	Water-saving	Other environmental advantages	Investment costs (€)	Effect on habits
Supply installation	Proximity of sanitary hot water reservoirs	YES	0.16 litres/drawn/m of pipework	Energy and materials (pipework) saving	/	NO
	Pressure reducer 	YES	2 to 9.5 l/min per tap according to pressure	Increases service life of installation	50 to 250	NO
	Leak detector	YES	2 to 9.5 l/min per tap according to pressure	Saves materials by preventing water damage	/	YES
Tapware and fittings	Dynamic flow limiter 	YES	55% for a low-cost shower	Energy-saving if hot water	No additional cost	NO
	Aerator mixer tap	YES	20% by comparison with a traditional mixer tap	Energy-saving if hot water	75 to 100	NO
	Automatic tap 	YES	60% (mechanical) 69% (infrared)	Energy-saving, if hot water	75 to 250	NO

SUSTAINABLE REFURBISHMENT OF SCHOOL BUILDINGS

3. REDUCE NON ENERGY RESOURCES CONSUMPTION



Sanitary appliances	Waterless urinal 	YES	100% by comparison with a traditional urinal	Increases service life of drainage pipework	500 to 600	NO
	Dual flush WC cistern 	YES	53% by comparison with a 9 l cistern	Reduces dilution of waste	75 to 100	YES
Other water appliances	Drinking fountains 	YES	Prevents water waste	Good for health, limits waste	450 to 1400	YES
	Two-bowl sink (kitchen) 	YES	Prevents water waste	Energy-saving	/	YES

Source: Information sheet «Faire un usage rationnel de l'eau» Guide pour la construction et rénovation de petits immeubles, IBGE [Brussels Institute for the Management of the Environment], 2007.

3.1.5. Recovery and use of rain water

The use of rainwater is an attractive response both economically and ecologically: it reduces tap water consumption and, thus, the quantity of water pumped from groundwater, it reduces the use of water softeners, both devices and chemical and reduces the dilution of waste water in sewers etc.

The use of rainwater is not just attractive for individuals, but also in industrial settings or in the context of local authority buildings (offices, schools, swimming pools, libraries etc.).

The main use of rainwater harvested in a school will be school cleaning, watering soft landscaping and, as applicable, supply to sanitary facilities, taking all precautions with regard to risk prevention and hygiene (especially for the youngest children).

3.1.5.1. Rainwater harvesting

Rainwater falling on the roof is collected via the gutters and rainwater downpipes. It then passes through a first filter in order to eliminate dust and particles before being stored in the tank. The stored water is pumped to the various appliances and taps.

The rainwater tank comprises:

- an overflow system, in case the tank overflows (e.g. from a succession of major storms);
- a feed system using drinking water;

The choice of materials for the system, its capacity, the choice of roof equipment and catchment surface to be connected to the system are issues that must be studied and assessed according to the desired rainwater consumption.

Rainwater is usually harvested from the roof surfaces of buildings. The slope of the roof, its orientation and covering will affect the volume of rainwater harvested:

SUSTAINABLE REFURBISHMENT OF SCHOOL BUILDINGS

3. REDUCE NON ENERGY RESOURCES CONSUMPTION

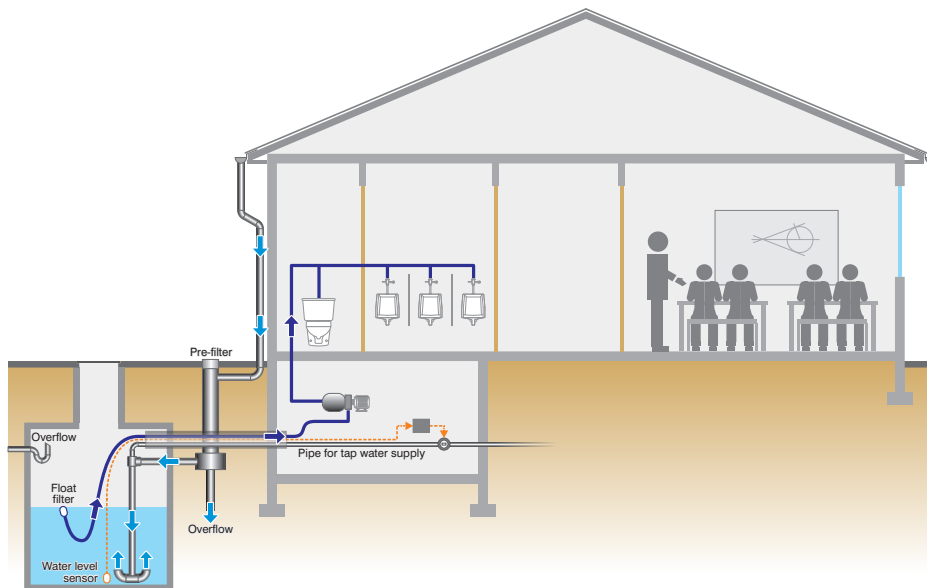

→ Slope and orientation

The slope of the roof and its orientation influence the quantity of water harvested.

- 0° to 30° slope: slope coefficient of one whatever the orientation;
- 30° slope: slope coefficient of 0.75 to 1.25 according to orientation;
- 40° slope: slope coefficient of 0.64 to 1.36 according to orientation;
- 45° slope: slope coefficient of 0.57 to 1.43 according to orientation;
- 55° slope: slope coefficient of 0.48 to 1.52 according to orientation;
- >55° slope: slope coefficient of 0.45 to 1.55 according to orientation;

→ Roof covering

Each roof surface that is rained upon is described by a runoff coefficient, which depends on the roughness of the surface, its slope, the saturation level of the covering etc. The following coefficients can be considered according to two types of rain:

Type of roof covering	Run-off coefficient	
	Normal rain	Heavy rain
Sloping roof		
Slate	0.85	1.00
Bitumen	0.88	1.00
Metal	0.88	1.00
Synthetic	0.88	1.00
Tiles	0.85	1.00
Glazed tiles	0.93	1.00
Flat Roof		
Bitumen	0.75	1.00
Gravel	0.60	1.00
Extensive roof - 5cm	0.50	1.00
Extensive roof - 10cm	0.50	1.00
Intensive roof (20 cm to 40 cm)	0.20	1.00

Source: IBGE - Comparaison de mesures alternatives pour la gestion des eaux de pluie à l'échelle de la parcelle - fiche informative – OUTIL GESTION EAU DE PLUIE OGE12, Author: V. Mahaut

SUSTAINABLE REFURBISHMENT OF SCHOOL BUILDINGS

3. REDUCE NON ENERGY RESOURCES CONSUMPTION



Pictures: Tatiana De Meester, Sophie Trachte

3.1.5.2. Rainwater filtering

The filtration systems allow water to be obtained that is of sufficient quality for supply to sanitary facilities, cleaning and/or soft landscape watering. Filtration of rainwater harvested from roofs is done in two stages:

→ Pre-filtration

A pre-filter with a mesh size of less than 2 cm is installed upstream of the tank inlet, in order to avoid an excessive inflow of organic material into the tank which could ferment there and give off an unpleasant smell, requiring frequent cleaning.

These pre-filters can be sited at the collecting surface, gutter, downpipe, or in the ground. The latter will then be provided with an inspection hatch for any maintenance purposes. Some manufacturers offer solutions that integrate the pre-filter into the tank. Self-cleaning pre-filters are preferred to non-self-cleaning filters, which require regular maintenance.

They are fitted with a fine stainless steel grid which traps leaves and other particles and lets approximately 90% of the water flow into the tank. The remaining 10% of water takes the dirt towards a second outlet. These filters can take different forms: pot filters, vortex filters or a pre-filter fitted vertically in a rainwater downpipe. The yield of a pre-filter is the percentage of water filtered as a ratio of the total quantity of rainwater passing through it. This yield may be reduced for lack of maintenance.

→ Post-filtration

If pre-filtering is adequate for operation, filtering downstream of the hydrophore pump will be necessary to protect appliances installed downstream from blockages or accumulation of suspended particles.

A mechanical filter is installed to retain fine particles:

- 1 to 9 microns: washing machines
- 15 to 20 microns: WCs



Warning, care must be taken to regularly clean the filters according to the quantity and quality of water filtered. Care must also be taken to monitor their airtightness, as they can allow growth of bacteria.

	Picture	Description	R (%)	Indicative Price (euros)	Comments
Rainwater downpipes		<p>Catchment filter</p> <p>Zinc, copper or plastic body, intended for installation on the rainwater downpipe, able to filter water from a roof up to 180 m². Stainless steel filter within the gutter. A filter is required for each downpipe.</p> <p>Suitable for downpipes of 80, 87, 110 or 100 mm. Requires upstream height of downpipe of at least 1 m. Connection to tank: 50 mm</p>	70 to 90	180 to 270	<p>Simple to install on existing rainwater downpipes.</p> <p>The yield reduces to 65% in the event of heavy rain</p>

SUSTAINABLE REFURBISHMENT OF SCHOOL BUILDINGS

3. REDUCE NON ENERGY RESOURCES CONSUMPTION



Ground	 <p>Picture © www.eaurigine.fr</p>	<p>Buried filter</p> <p>Plastic body with stainless steel filter. Self-cleaning filters or provided with a basket to be periodically emptied.</p> <p>Suitable for roof surfaces of at least 350 m² up to 1500 m².</p> <p>Height adjustable thanks to a telescopic adjuster. Cover can be suited to pedestrian or vehicle traffic.</p>	95 to 100	300 to 1000 according to capacity	Requires a depth that is not always available.
		<p>Dual filter</p> <p>Buried installation for roofs up to 350 m², comprising a 5 mm (large mesh) pre-filter and a 0.5 mm or 1 mm (fine mesh) filter.</p> <p>For an installation to be buried, the filters are complemented by extension tubes and covers. They can also be placed in an inspection chamber (without cover or extension tube).</p>	99	430 with extension tube and cover	Horizontal system, requiring less depth.

Source: IBGE - Comparaison de mesures alternatives pour la gestion des eaux de pluie à l'échelle de la parcelle - fiche informative –OUTIL GESTION EAU DE PLUIE OGE09 – Author: V. Mahaut

3.1.5.3. Rainwater storage

A tank is a closed storage reservoir for temporary storage of rainwater. It can be constructed of masonry or prefabricated, concrete or synthetic, buried or not. There are two very distinct types according to the water management goal: the harvesting tank and the stormwater tank. We shall deal here principally with the harvesting and/or storage tank whose essential purpose is harvesting, conservation and giving value to rainwater through its domestic use. The design of such tanks depends upon the average regional rainfall, its frequency, the harvesting surfaces and the use to which that water will be put.

The storm water tank (or pond, or holding chamber) is meant for the temporary harvesting of water from very heavy rain, which is then discharged to the outlet at a flow rate controlled so as not to overload the downstream network when the water level is at its highest. The intention is that this structure should most often be empty, so that it can fulfil its water management purpose during the next downpour.

→ Design

When designing a tank, the goal is that it should, as often as possible, be sufficiently full of water to be able to meet certain needs. The rainwater tank should be designed so as to optimally meet requirements (80% to 90%).

The design principle of a rainwater harvesting tank is to determine its volume when filled to capacity. This volume depends



Picture: © www.gerbaud.com



Pictures: © www.maisonpassive.be

SUSTAINABLE REFURBISHMENT OF SCHOOL BUILDINGS

3. REDUCE NON ENERGY RESOURCES CONSUMPTION



upon:

- rainfall: annual average, distribution over time (frequency and intensity);
- the runoff supply surfaces: size, slope, orientation and covering;
- the demand for harvested water;
- the desired degree of autonomy with regard to the top-up by mains water.

The method proposed by the Vlaamse Milieu Maatschappij in the brochure *Waterwegwijzer voor architecten* (available on the Internet at <http://www.waterloketvlanderen.be/publicaties>) is valid for central European climates.

→ Materials

Two types of materials are available for rainwater harvesting: inert materials (concrete or fired clay) and synthetic materials. The material from which the tank is made must be watertight and preserve the water quality. This is why one-piece, prefabricated concrete tanks, or tanks constructed of cement-rendered masonry are preferred for their capacity to neutralise the acidity of rainwater. Their bottom surface only may, possibly, be tiled for ease of maintenance.

If local conditions lead towards choosing a tank of synthetic material, care should be taken that it is opaque and made of recycled or actually recyclable material. Limestone is put in it to neutralise the acidity of rainwater, which is necessary to prevent corrosion of water pipes, tapware and valves.

Metals are to be avoided insofar as their contact with rainwater generates corrosion.

→ Installation

According to the layout of the building, the rainwater tank will be located where it is sheltered from external pollution, in a cool, dark place to avoid the growth of algae and, if possible, on a 10 cm bed of sand. Ideally it will be buried; it can also be located above ground in a cellar, in the garden or even on the upper floors of a building from the point of view of a gravity-fed supply, if the building structure permits.

Ideally, a rainwater tank should be buried, protected if necessary from unwanted infiltration by a waterproof render. If local conditions favour the choice of an above-ground tank, care should be taken to place it in a cool place, protected from the sun. It should be installed on a stable surface.

The tank must be accessible, in particular for cleaning and checking equipment:

- The inlet pipe cover must be free of all vegetation or deposits;
- The opening must be large enough to allow a person to enter the tank;
- The bottom of the tank must be solid enough to support the weight of a ladder with a person on it.

In urban areas, for purposes of maintenance of the tank and its filters, the tank must be divided into two sections:

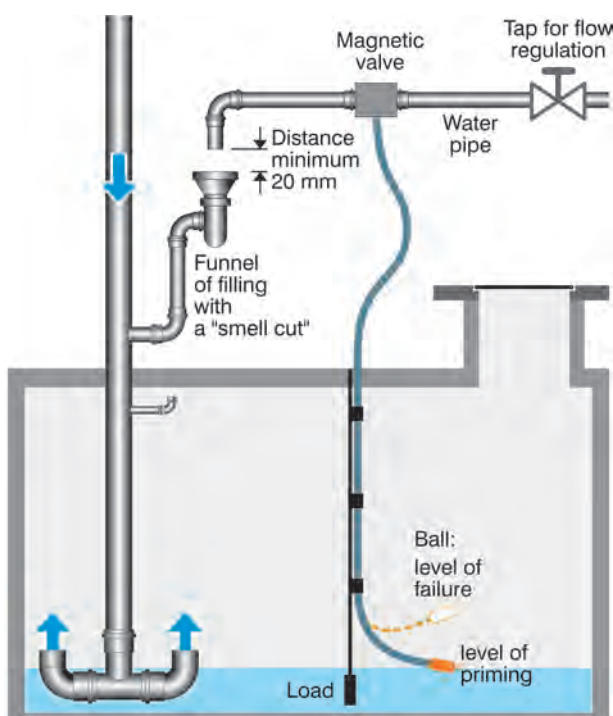

SUSTAINABLE REFURBISHMENT OF SCHOOL BUILDINGS

3. REDUCE NON ENERGY RESOURCES CONSUMPTION



- An initial section serving as a settling pond, with a capacity 10% to 20% of that of the second section and the surplus of which feeds the second section;
- A second section serving as the actual reservoir.

→ Equipment

A rainwater harvesting tank should be equipped with the following items (see diagram):

- Calmed inlet for rainwater;
- Mains water top-up feed;
- Aeration system;
- Gauge or level detector (optional);
- Overflow outlet;
- Drain down facility;
- Access for maintenance: hatch or manhole according to the size of the tank.

→ Tank maintenance

Tank maintenance comprises:

- Cleaning every 5 to 10 years (if there is a filter upstream of the tank), cleaning the tank bottom in dry periods using a high-pressure cleaner, a cleaning brush or a spray hose. Use of chlorine bleach is strongly discouraged and is unnecessary.
- Regular cleaning out of inlets and outlets using a controlled flow rate or by overflow;
- In winter, emptying non-buried tanks/casks that are exposed to frost.

3.1.5.4. Feed, distribution and hydrophore pump

→ Various methods of distribution

Draw-off points can be fed in various ways according to, on the one hand, their purpose and the quantity of water to be distributed and, on the other hand, their location in relation to the tank.

- Using an electric pump: water is drawn from the tank and pumped (under pressure) into the pipes feeding the draw-off points.
- Using a manual pump: water is drawn manually and flows along. There are also manual suction and high-pressure pumps for feeding a draw-off point at a distance from the pump.
- By gravity: water flows from the tank, which is located above the distribution system. The pressure is a function of the height of the water level in the tank in relation to the draw-off point (1 bar represents a 10 m water column).
- By direct flow: water is drawn from the bottom of the tank, which is fitted with a tap that can have a hose pipe attached for general outdoor use.

→ Types of electric pumps in current use

The most frequently used pumps are centrifugal ones. These are composed of impellers located within an enclosure (pump body) with two or more openings, the first one in the axis of rotation (intake), and the second perpendicular to the axis of rotation (discharge). The liquid held between two impeller blades is forced to turn with them, centrifugal force then pushes the mass of liquid outwards from the impeller, where the only outlet is the discharge opening. The fluid energy is, thus, that derived from the centrifugal force.

There are both monocellular and multicellular pumps. The monocellular system has the advantage of using few components, which makes it more robust, but it is noisier. It requires more power from the motor and there is a rapid loss of pressure when flow is increased. The multicellular system has the advantage of requiring a less powerful motor, being quiet and discharging water at an adequate pressure. However, the greater number of components compared with the monocellular system makes it less robust.

There is also another type of pump, the displacement pump (piston, screw, gear, diaphragm etc.). These mainly differ from centrifugal pumps by their field of application: Centrifugal pumps are more suited to high volumes (5 to 10,000 m³/h), but with small pressure differences (1 to 20 bar). Displacement pumps are better for small volumes (0 m³/h to 10 m³/h) for large pressure differences (1 to 4000 bar)

SUSTAINABLE REFURBISHMENT OF SCHOOL BUILDINGS

3. REDUCE NON ENERGY RESOURCES CONSUMPTION



Other advantages of centrifugal pumps as compared with displacement pumps:

- For the same specification, they are more compact.
- Simple construction, without valves;
- Easy-to-use;
- Inexpensive;
- Better performance;
- Even and quiet flow;
- In the event of clogging or obstruction to the discharge pipe, they do not suffer damage and there is no burst risk to the installation.

→ Characteristics of widely-used pumps

The table below shows the most widely-used types of pump that are marketed under several brands (collective use only).

Description/bulk/indicative price	Application/assessment
 <p>Submerged pump</p> <p>This type of pump is placed directly in the tank. It has the characteristic of being able to operate over large distances between the water storage tank and draw-off points.</p> <p>Bulk: Base diameter = 175 mm; 540 mm to 710 mm.</p> <p>Indicative price: 200 to 600 euros</p>	<ul style="list-style-type: none"> • Designed for distribution of water in commercial operations and for rainwater harvesting. • Space-saving, as placed at the bottom of the tank; • More demanding; Silent; • Pump cooled by the fluid being pumped (water).
 <p>Combined systems</p> <p>It is possible to opt for assembly of two pumps in series to improve yield and assure continuity of supply in the event of maintenance or repair of one of the pumps.</p> <p>Bulk: L = 835 mm; W = 660 mm; H = 1225 mm.</p>	<p>System adapted to rainwater harvesting in multi-occupancy buildings and small commercial operations (50 to 60 WC) for drinking water-saving in conjunction with tanks or reservoirs</p>
 <p>Combined tank + pump systems</p> <p>Tank in synthetic material and pump with electronic control. Some models allow automatic filling of the tank.</p> <p>Bulk: L = 1730 mm; W = 820 mm; H = 1700 mm.</p> <p><small>Pictures © wilo.be</small></p>	<ul style="list-style-type: none"> • System suited to existing buildings. • For greater capacity, tanks can be installed in series.

Source: IBGE - Comparaison de mesures alternatives pour la gestion des eaux de pluie à l'échelle de la parcelle - fiche informative –OUTIL GESTION EAU DE PLUIE OGE09 – Author: V. Mahaut

→ Rainwater inlet (in the tank)

The rainwater inlet in the tank must be installed according to the diagram below. This method allows the avoidance of turbulence at the bottom of the tank, where sludge deposits form from settlement.

→ Drinking water feed (in case of drought)

In the event of a prolonged drought, the rainwater tank may empty either completely or partially and it is necessary to allow for a drinking water feed. A permanent connection between the two networks is not permitted. It must be possible to completely separate the two networks.

This can be performed manually or automatically:

SUSTAINABLE REFURBISHMENT OF SCHOOL BUILDINGS

3. REDUCE NON ENERGY RESOURCES CONSUMPTION



- Manually: filling the tank by hose pipe or by a permanent filling system (filling according to estimated consumption before the next rainfall).
- Automatically: the pump's float, at its low point, opens the drinking water feed valve, which feeds the tank with an adequate quantity of drinking water for one day's needs.

→ **Overflow system**

The rainwater tank must be provided with an overflow system. This will only operate approximately 10 times a year, according to the design of the tank. For sustainable refurbishment, it is advised to connect the overflow to a system of ground infiltration, such as a soakaway, ditch, pond etc., so as to discharge the surplus rainwater to groundwater.

When this first solution is not practicable for technical or economic reasons, the overflow should be connected to the public utility, taking certain precautions according to the characteristics of the network (anti-return valve, trapped inlet to overflow pipe).

3.1.5.5. Rainwater in the school: inform and protect

To ensure appropriate use of rainwater in schools and to do so safely, the supply network to draw-off points should take account of the following:

→ **A separate network**

In order to maintain separation between mains water and rainwater, a separate network of indoor pipework should connect only those appliances meant to use water from the rainwater harvesting system.

→ **Identification of the rainwater network**

It must always be possible to clearly and immediately distinguish between installations supplied with drinking water and those supplied with rainwater. To this end, they shall be permanently and clearly marked by the following means:

- Marking of pipework (colour rings, coloured pipework);
- «Non-potable water» labels in the immediate proximity of rainwater draw-off points;
- Possible colouring of rainwater (preferably blue or green);
- A schematic diagram of installation identifying the various components.

→ **Selection of materials**

The natural acidity of rainwater risks eventually corroding metal pipework and, thus, significantly degrading the water quality. Synthetic pipework in PVC, PE or polybutene should thus be preferred.

→ **Safety**

Outside taps must be installed out of the reach of children (160 cm height) or secured. Some service taps can be provided with a special key.

→ **Information**

The school can inform all parents, teachers and children about the design concepts and advantages of the rainwater harvesting system implemented there. This can be done in the form of display panels so as to make the whole school population aware of this issue.

SUSTAINABLE REFURBISHMENT OF SCHOOL BUILDINGS

3. REDUCE NON ENERGY RESOURCES CONSUMPTION



3.2. Replenishing water resources and reducing rainwater runoff



The water cycle is mainly driven by the sun and the Earth's gravity, which give water the energy it needs to circulate on the Earth's surface (the water cycle's processes of evaporation, precipitation, transpiration, runoff, infiltration). Natural imbalances can appear when humanity, for its own needs, disturbs the natural water cycle. Increasing soil sealing and urbanisation, as well as the increased intensity of storms cause more and more flooding of public and private infrastructure. Runoff, pollution and pumping are the main disrupters of the natural cycle and are associated with urbanisation, industrial development and the highway network, population increase and changes in behavioural standards with regard to water.

An approach that combats soil sealing involves:

- reducing soil sealing on the plot of the building under refurbishment, particularly by selecting permeable ground coverings, by setting out green areas of open ground, by planting trees and hedges etc.;
- reducing the impact of soil sealing on the plot of the building under refurbishment by proposing and installing compensatory measures.

Managing the water cycle by reducing runoff water allows mitigation of the following: erosion, flooding, drying out of groundwater, loss of the purification function of the ground, dilution of wastewater and increasing quantity of wastewater to be treated etc. Proposing and implementing compensatory measures also allows works to be carried out on other aspects, such as biodiversity, improvement of outdoor spaces, improvement of air quality etc.

3.2.1. Design concepts for integrated management of rainwater

→ Minimising runoff

Limiting the volume of runoff water can be achieved in several ways, observing the following order of priorities:

- Limiting the footprint of buildings by increasing density, if possible, by height rather than horizontally;
- Setting out non-built-up areas as green areas of open ground, planted and, as far as possible, flat (possibly terraced);
- Allowing for permeable surfaces to adjacent areas and grey spaces (access, parking areas etc.) such as gravel, stabilised dolomite, open-jointed blocks, stabilised lawn etc. that have low runoff ratios.

→ Avoiding rainwater runoff by harvesting, infiltration and/or evaporation of water

Once rainwater is running off surfaces, it is important to reduce the volume of runoff by encouraging one of the processes of the natural water cycle. Water can be infiltrated into the ground, evaporated from the surface of a body of water or subjected to evapotranspiration by plants. There are various means for achieving these objectives:

- Planting trees on adjacent areas and grey spaces so as to allow the rain to be intercepted by their leaves and then to be subject to evapotranspiration;
- Installing green roofs (intensive or extensive) on the flat or low-pitch roofs, which particularly allows evapotranspiration of water by plants;
- Implementing construction that permits infiltration into the ground of excess, unpolluted runoff water;
- Implementing construction that allows evaporation of water from collecting surfaces of roofs;
- Emphasising the water cycle as an element that structures public space through physical features that channel rainwater in multifunctional visual devices: infiltration ditches, landscaped infiltration ponds etc.

Integrating these structures into landscaping is often a measure of occupant awareness and of better performance of the structure (thanks to proper maintenance resulting from diverse use of the premises).

It should also be noted that certain devices such as ponds, pools, dry basins must be adapted to the educational context and safety measures must be taken to avoid any risk of drowning.



→ Collection and slow release of rainwater

If runoff water cannot find an outlet such as the ground or the air, it is still possible to slow it down so as to defer its draining, reduce pressure on the downstream network during heavy rain and prevent possible flooding. Available means involve setting aside an empty volume that can temporarily fill up with water in the event of heavy rain:

- Implementing measures to channel and reduce the speed of water flow: drainage channels, swales or very rough pipes that follow a long route and are flat bottomed, possibly staircased or terraced etc.
- Implementing temporary water retaining measures to roofs (rainfall-retaining roofs). Rainfall-retaining roofs (see picture on right) offer a greater volume for water storage than green or gravel roofs for the same depth of water, because of they do not comprise fill material.
- Implementing structures or measures for rainwater retention in order to allow its discharge to an outlet with a limited or controlled flow rate. Such structures can take the form of swales, dry basins, or infiltration ditches, drainage blankets etc. They may have a minimal or plant covering. Storm water basins and tanks fall within this category of structures.
- Installing rainwater harvesting tanks in order to put the water to use: harvested rainwater is then used for various purposes.

→ Limiting pollution of runoff water

The quality of all water must be carefully analysed when it is discharged into the natural environment or the drainage system. The ground and the sea have a natural purification function, but this function is limited and variable. It is important to respect it and assist it if the volume of dirty water or the pollution is too great, in order to limit the risk of groundwater and environmental pollution.

Runoff water contains various pollutants present in the atmosphere (absorbed during precipitation) or on the runoff surfaces: dust (atmosphere, roofs, parking areas, adjacent areas etc.), sand (atmospheric, from adjacent areas etc.), organic material (moss, green roofs, animal and plant debris etc.), fertiliser, phosphates (green roofs), heavy metals (metal roofs, highways) etc.

When the site is in the proximity (less than a kilometre) of a protected water catchment area, pre-treatment of runoff water should be considered for large parking areas and for main paved areas, so as to improve the quality of discharges into the natural environment.

3.2.2. On-site water management (around the buildings)

«On-site management of rainwater aims to compensate for soil sealing inherent in the construction and setting out of adjacent areas. Its goal is to reduce runoff and mitigate the load on existing public drainage infrastructure. It contributes to flood prevention and prevention of surface water pollution as well as replenishing groundwater.» Source: Guide pratique à la construction et rénovation durable de petits bâtiments, IBGE, 2007

Several measures, of proven effectiveness, can be quickly and easily implemented:

- Encouraging the setting out of green areas and, more particularly, doing so in the courtyards of buildings and in the centre of islands;
- Increasing the permeability of grey spaces (terraces, driveways, parking areas);
- Encouraging green roofs (acting as storm water basins).

3.2.2.1. Useful indices

→ Soil sealing ratio

The soil sealing ratio is the relationship between the surface of impermeable ground and the total surface of the plot. During the redevelopment of the plot, the project author should take care that the soil sealing ratio is between 0.4 and 0.2.

Traditional	Effective	Very effective
80 to 40%	40 to 20%	< 20%

→ Soil infiltration coefficient

The infiltration capacity of a soil corresponds to its permeability. It is expressed in mm/h (or in m/s). The table below gives an order of magnitude for the infiltration capacity for different types of soil.

SUSTAINABLE REFURBISHMENT OF SCHOOL BUILDINGS

3. REDUCE NON ENERGY RESOURCES CONSUMPTION



Type of ground	Infiltration capacity
Coarse sand	500
Fine sand	20
Fine, silty sand	11
Light gravel	10
Turf	2.2
Silt	2.1
Light clay	1.5
Moderately heavy clay	0.5
Loam	0.4

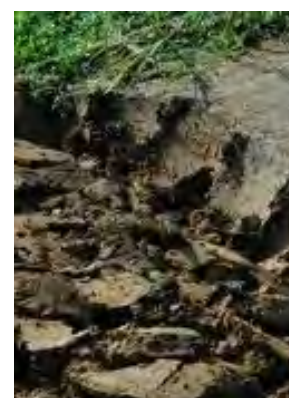

When there is a layer of backfill in the ground, a permeability test becomes essential. An infiltration measurement test allows determination of the infiltration capacity of a soil. This test can be carried out quite easily without major technical or financial means.

3.2.2.2. Planting of the plot

During the refurbishment of the plot and its common areas (around the school buildings to be refurbished), it is possible to implement certain planting arrangements that enable rainwater retention and infiltration. These arrangements have the advantage of reinstating or strengthening the site's biodiversity as well as improving the quality and comfort of these outdoor areas.

→ Soft landscaping for water retention and infiltration

Certain types of planting, such as trees, hedges and bushes can facilitate the retention and infiltration of rainwater and runoff.

→ Retention and collection installations

Gulleys and channels

Natural systems that can be integrated into the layout of large and medium-sized building complexes, as separating and design elements.

Wide, flat and open channels with a shallow slope are created to channel water to underground pipework. The course of the water is made visible and accessible.

Green roof

Green roofs are also important elements for rainwater management on the plot, because they function as storm water basins and, during heavy rainfall, they relieve pressure on the drainage network by providing temporary holding and a delayed, gradual flow.

3.2.2.3. Selection of ground cover materials (adjacent areas, traffic and parking areas etc.)

During refurbishment of the outdoor and common areas of the school, the designers will prioritise permeable paving for parking spaces, access driveways and areas other than playgrounds, in order to allow rainwater infiltration (See table, next page).

3.2.3. Rainwater retention and infiltration system

Gradually, the urbanisation of medium and large European towns and cities, as well as their conurbations has led to a considerable amount of soil sealing, contributing to flooding incidents.

This soil sealing, inherent to infrastructure and construction, can be compensated for at the level of the individual plot and of the building. One of the major objectives of the procedure proposed below is to noticeably reduce this soil sealing by

SUSTAINABLE REFURBISHMENT OF SCHOOL BUILDINGS





3. REDUCE NON ENERGY RESOURCES CONSUMPTION



encouraging the use of alternative compensatory techniques (swales, green roofs, rainwater storage tanks etc.).

These compensatory measures have the advantage of being multifunctional, i.e. they can play various roles in private or common areas (playing field, green area, water catchment area etc.) and noticeably improve the quality of these spaces thanks to a great variety of plants and materials.

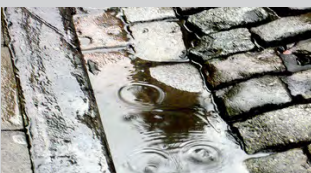
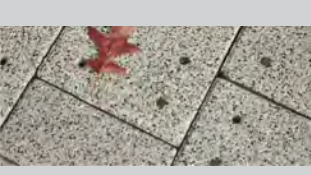
The measures proposed below are ones that can be applied without danger or risk in school common areas and play areas.

Ground cover materials		
Gravel		Ground covering of natural stone pebbles or pea shingle. The thickness of the covering and size of grains depends upon the load to be supported. Simple, cheap installation. Not suitable for heavy traffic.
Dolomite		Ground covering composed of a mix of coarse dolomite, cement, mixing water and lime. A geotextile membrane keeps the layers separate and prevents weed or plant growth. Not suitable for frequent vehicle traffic.
Wide-jointed paving		Concrete or natural stone paviments laid with wide joints (2 to 3.5 cm). The joints are filled with fine gravel or coarse sand. Permeability is reduced if vegetation grows in the joints.
Permeable paving		Perforated concrete paviments with small channels on the lower surface to discharge water.
Concrete cellular grassed paving		Pierced concrete slabs, filled with soil and grass seed. The paviments are laid on a substrate with a gravel foundation. According to the specification, grass occupies between 35% and 65% of the surface area. The slabs are suitable for traffic and vehicle parking. Regular maintenance of the grass (fertiliser, mowing etc.)
Plastic cellular grassed paving		Slabs made from high-density recycled polyethylene. When assembled they form a cellular layer which is filled with gravel or soil and grass seed. Lightweight, robust system – simple installation.

3.2.3.1. Swales

A swale is a shallow depression in the ground that serves the purpose of collection, retention, flow and/or infiltration of rainwater. As it is shallow, can be temporarily submerged and has shallow-sloping banks, it is usually, but not exclusively, laid out as a green area. As a long feature, with banks that may or may not be parallel, its form can follow contour lines and

SUSTAINABLE REFURBISHMENT OF SCHOOL BUILDINGS

3. REDUCE NON ENERGY RESOURCES CONSUMPTION



it can narrow in certain places. A network of open-air swales can replace an underground rainwater network, with the advantage of simple design and being inexpensive. Its advantages make it the most widely-used of alternative techniques.

Rainwater collection

Rainwater is collected either using pipework (for recovery of water from roofs or carriageways), or directly after runoff on adjacent surfaces.

Principal purpose

Holding rainwater from a more or less heavy rainfall episode. Holding and flow occur in the open air within the swale.

Discharge

The water can be discharged to a drainage outlet or by infiltration and evaporation (preferred solutions).



Swales - Picture: V. Mahaut

3.2.3.2. Dry basin

A dry basin is like a widened swale. It has a rounder shape and it is used more for holding water so that it can infiltrate into the ground or for returning it to the drainage outlet. The banks of dry basins often have shallow slopes but can be steeper and the depth of water can be greater than in swales. As they can be temporarily submerged, they are most often, but not exclusively, set out as green areas, they can have either a plant or hard surface covering. Storm water basins with hard-surfaces to their bottoms and vertical sides (concrete, slabs etc.) are a particular type of dry basin. The dry basin is generally the final stage in a possible succession of alternative measures leading up to the drainage outlet.

Rainwater collection

Rainwater is collected either using pipework, or directly after runoff on adjacent surfaces.

Principal purpose

Open-air holding of water from a rainfall episode. It acts to spread out and cap rainwater levels.

Discharge

The water is discharged to a drainage outlet or by infiltration and evaporation (preferable).

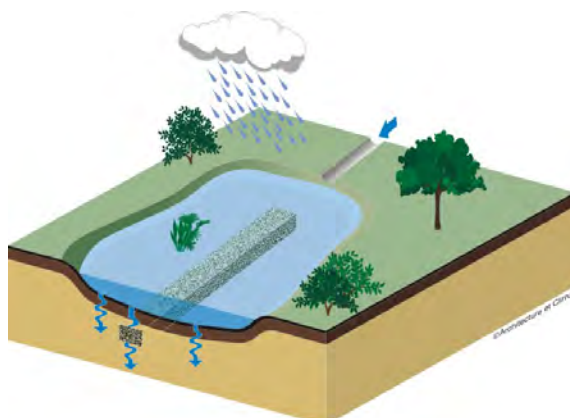

School in Scharnhäuserpark - Germany - Picture: V. Mahaut

SUSTAINABLE REFURBISHMENT OF SCHOOL BUILDINGS

3. REDUCE NON ENERGY RESOURCES CONSUMPTION



3.2.3.3. Soakaway

Soakaways are holes in the ground filled with very porous granular material gravel, pebbles and crushed rock (without sand), cellular materials etc. Soakaways are often, but not always, covered with a finish according to their surface use (concrete slab, lawn, porous asphalt, pebbles, porous slabs, porous concrete etc.). If they are not covered, the granular material is exposed to the open air. They can be planted like a gravel-filled lagoon and be part of the purification process for runoff water.

When grassed over, they can be rendered invisible in a garden. Generally, soakaways covered in the same material as is used for their immediate environment (hard surface, dolomite, lawn, planted bed etc.) can be unnoticed. Rainwater storage occurs in the spaces within the granular material and does not overflow the upper surface. The water is then infiltrated into the ground and/or returned at a regulated flow rate towards a drainage outlet.

Catchment

Rainwater can infiltrate the soakaway in three different ways:

- By injection into the soakaway: water is harvested on adjacent, impermeable surfaces using pipes or drainage channels. The water is then injected into the granular structure via gulleys or dispersal drains installed in the upper part of the granular base course.
- By run off to the top surface of the structure: runoff water from adjacent impermeable surfaces flows towards the soakaway, perpendicularly to its length and is distributed over its upper surface. This water then infiltrates to the granular structure through a permeably paved surface.
- By infiltration directly into the soakaway: rain falling on the surface does not run off, but is caught by a permeable surface, which allows it to infiltrate directly to the underlying, granular base course.

Principal purpose

The essential purpose of a soakaway is to hold the water from a rainfall episode. The water is held in the granular structure.

Discharge

The water is discharged to a drainage outlet or by infiltration into the ground and, to a smaller extent, by evapotranspiration. These various methods of discharge are combined according to the capacity of each. Soakaways may be used alone, as a complete alternative technique, or to complement other techniques.

→ Trench

A trench is a linear soakaway 1 meter to 2 metres deep, similar to a ditch filled with granular material, with or without a surface covering. Frequently, water comes directly from runoff from surfaces adjacent to the trench and perpendicular to its length, e.g. along a roadway.

→ Permeable parking areas

A permeable parking area is, in effect, a soakaway surfaced in a porous material. Rainwater landing on that surface does not run off, but infiltrates directly into the granular base course. The permeable parking area only catches rainwater falling on its surface (rainfall) and, thus, it does not manage runoff water from other surfaces that are impermeable.

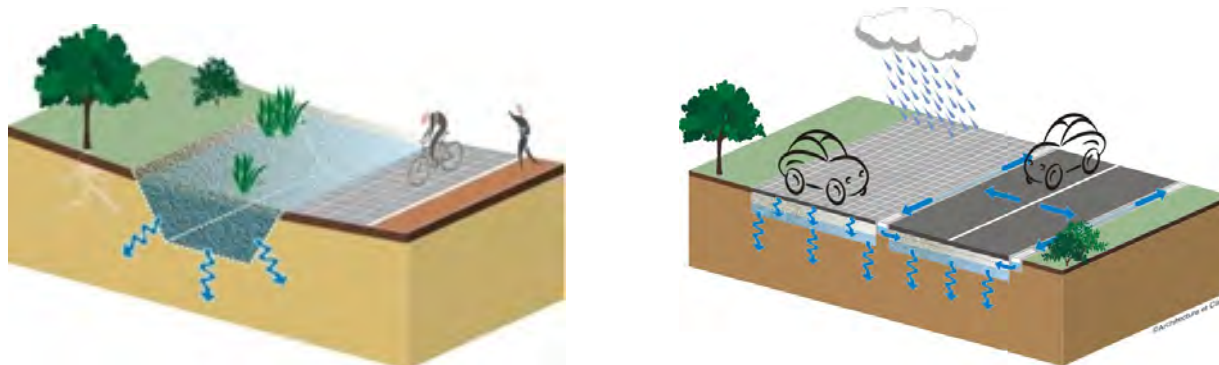

3.2.3.4. Shafts

A shaft several metres, even tens of metres, deep can be used to allow runoff water to flow to a permeable subsoil in order to provide a discharge flow rate compatible with the catchment surfaces drained after holding and any pre-treatment. This solution is often chosen when the surface soil layers are impermeable, but there is a permeable subsoil. It often drains large surfaces (> 1000 m²) and requires no drainage outlet other than the subsoil.

SUSTAINABLE REFURBISHMENT OF SCHOOL BUILDINGS

3. REDUCE NON ENERGY RESOURCES CONSUMPTION



Catchment

Water is collected using pipework or drainage channels, and may be pre-treated and stocked in the open air upstream of the shaft or in the shaft.

Principal purpose

The essential purpose of a shaft is to conduct drainage water to a very permeable stratum. The water infiltrates into the ground through the bottom of the shaft and possibly through the side walls if it is designed for that. It may also be used for holding and, in spite of its small surface area, it can hold a great deal of water.

Discharge

The water is discharged by infiltration to the permeable subsoil.

The shaft is often associated with and receives the outflow from holding techniques such as below-paving storage, porous trenches, ditches or even holding ponds. It is, thus, the ultimate drainage outlet for either an open-air or soakaway system. It can also function as an emergency system in the event of exceptional rainfall. It is, moreover, possible to increase the infiltration from open ditches by placing filter pits along their length.

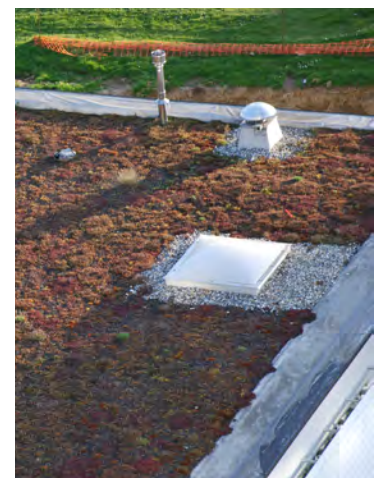
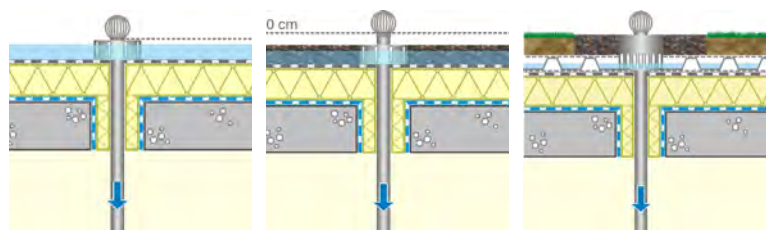
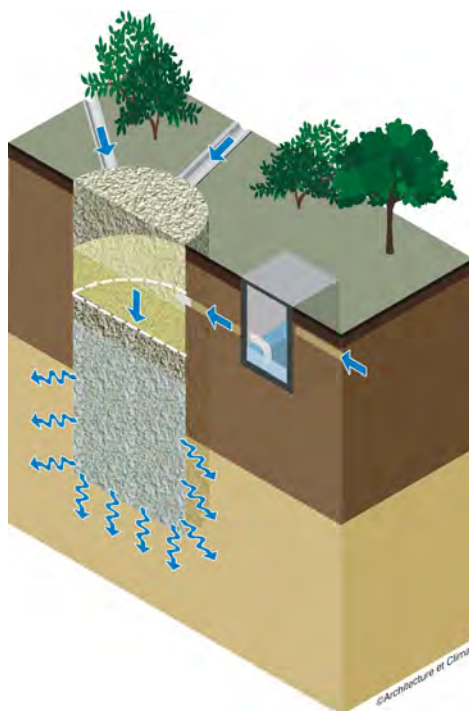

Pictures: Tatiana De Meester and Sophie Trachte

3.2.3.5. Rainfall-retaining roofs

Rainfall-retaining roofs are roofs that can temporarily hold a small volume of rainwater very close to the catchment surface (the roof). This technique is used to slow rainwater runoff on flat roofs as early as possible.

The principal is to retain a certain level of water (several centimetres) by using a parapet around the roof, a planted substrate or a layer of rounded aggregate and then discharging this water through evaporation, evapotranspiration and/or low flow rate release.

Catchment

Rainwater is collected directly on the roof surface. No special catchment structure is necessary, unless the water is also coming from a higher level roof.

Principal purpose

The essential purpose of the roof is to catch rainfall and to hold it temporarily.

Discharge

Water is discharged by evaporation in the case of water-holding roofs, and by evapotranspiration in the case of green roofs and/or at a regulated flow rate towards a drainage outlet (Rainwater downpipe, wastewater system etc.).

Rainfall-retaining roofs are used as a prior technique to other techniques to offset soil sealing.

SUSTAINABLE REFURBISHMENT OF SCHOOL BUILDINGS

3. REDUCE NON ENERGY RESOURCES CONSUMPTION



3.2.3.6. Design principles

On the basis of meteorological and rainfall observation datas, rainfall models, known as Project rainfall, may be calculated and used to design hydraulic structures.

Each hydraulic goal is defined by:

- the occurrence of a rainfall event, i.e. its recurrence interval;
- a maximum outflow rate that must not be exceeded;
- an emptying time that must not be exceeded.

→ Outflow rate

The outflow rate is the flow rate expressed in litres per second of the outflow from the plot towards the drainage outlet (drain, river etc.).

For a selected outflow rate and rainfall recurrence interval for a particular project, designing the structure comes down to the definition of a retention volume.

→ Retention volume

The retention volume is a volume of water to be held which will not, during the anticipated rainfall episode, be infiltrated, evaporated, evapotranspired or discharged at a regulated flow rate to a drainage outlet.

→ Emptying time

Once the rain is over, the facility can slowly empty by infiltration, evaporation, evapotranspiration or, at a defined regulated flow rate, to a drainage outlet and it will then await the following rainfall to serve its purpose again. In general, it is recommended that the emptying time should not in any event exceed two days. Ideally, it should not exceed six to 12 hours, in order to avoid nuisance from smell and mosquitoes in summer.

SUSTAINABLE REFURBISHMENT OF SCHOOL BUILDINGS

3. REDUCE NON ENERGY RESOURCES CONSUMPTION



3.3. Controlling consumption of natural resources



The world around us is made up of matter, energy and information. Matter and energy are considered to be raw materials, i.e. materials extracted from or produced by the natural world, and used as components or sources of energy in the production and transport of finished goods. The construction sector today is the biggest consumer of energy (45%) and of raw materials (50%) in Europe. It is thus necessary to address this issue in the course of sustainable refurbishment of school buildings, particularly by way of construction materials and processes.

Materials are the matter that is transformed into a finished product by the addition of energy and information. All materials or construction products consume energy and other resources during their whole service lifetime:

- **Energy resources** (coal, fuel oil, natural gas, hydraulic energy, electric power etc.) that are mainly used as fuel for transport and processing;
- **Non-energy resources** (plants, animal or mineral materials, including metals, petrochemical products, recycling products etc.) which are used as components or inputs in the manufacture of construction products;
- **Water resources** are used as components and/or elements in a manufacturing process or a phase in the fabrication process (dressing, sawing, mixing etc.) or both.

All these resources can be described by the more generic term «natural resources». Natural resources are defined as the various animal, vegetable or mineral resources on Earth that are necessary for human life and economic activity. These resources can be subdivided into two distinct groups according to the fragility or availability of the resource:

- **Non-renewable resources**, which are constituted of mineral raw materials (minerals, metals, rock) and fossil fuels (oil, natural gas, coal etc.). These various resources come from deposits formed during the Earth's geological history and constitute a stock that is, of its very essence, depletable;
- **Renewable resources** which can, in principle, be exploited without depletion, as they can permanently regenerate themselves. These various resources include sources of renewable energy (solar, wind, hydraulic, biomass), water, soils (cultivable land) as well as biological resources made up of the living resources exploited by humanity (forests, pastures, maritime fisheries, biodiversity – animal and vegetable species) and by the varieties of cultivated plants and breeds of domestic animals.

Renewable resources have very variable regeneration periods, which can range from several months for cultivable resources to more than 30 years for construction timber. This regeneration period is, thus an essential factor in comparing two renewable resources.

E.g.: Hemp and linen: a few months to grow; Cork: 9 years; Construction timber: 20 to 30 years.

Each resource is characterised by its properties, its availability and its place of origin. It is these properties that form the intrinsic qualities of the material and, consequently those of the finished product – its technical and/or physical performance – and that affect its impact on the environment.

A sustainable approach in terms of selection of construction materials necessarily implies limiting exploitation of natural resources as far as possible.

Implicit in this approach, is completion of the life-cycle of materials, i.e. rendering the flow of materials cyclical by making maximum use of waste – produced during the various phases of the life-cycle of the materials – as raw materials for the fabrication of new materials and/or the construction/refurbishment of buildings.

According to this principle, buildings must, thus, be considered as stores of raw materials and the traditional channels of waste treatment as sources of potentially exploitable secondary materials.

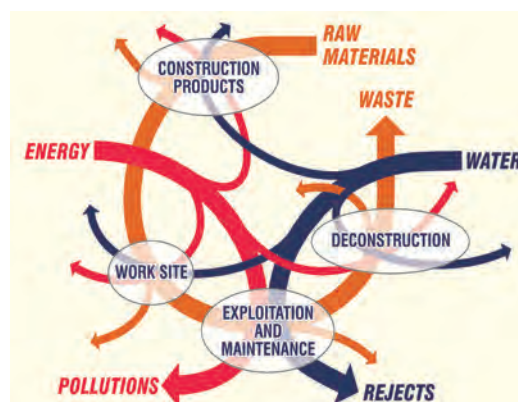

Illustration: Building life cycle by E. Dufresnes

SUSTAINABLE REFURBISHMENT OF SCHOOL BUILDINGS

3. REDUCE NON ENERGY RESOURCES CONSUMPTION



3.3.1. Various available resources

3.3.1.1. Non-energy natural resources

Non-energy natural resources are used in the industrial construction sector, in their natural state and/or in the form of raw materials as inputs to a manufacturing process.

Non-energy resources = raw materials

Production of building materials and products consumes raw materials and water in a greater or lesser quantity according to the type of materials/products and manufacturing process.

E.g.

- In Belgium, 1 m³ (2400 kg) of standard, heavy, reinforced concrete cast in situ requires approximately 350 kg cement, 1800 kg aggregates (sand and granular material), 100 kg steel reinforcement and 200 L water.
- 1 tonne of clinker (1 m³ of cement) requires 1.7 tonnes of raw materials.

Site-level construction methods will also affect the quantity of materials and volume of water to be used.

E.g.

Timber frame construction as compared with traditional, concrete and masonry block, construction.

Preference should, thus, be given to construction methods that consume less water and raw materials, in particular encouraging prefabrication and dry construction methods etc.

3.3.1.2. Recycled resources

Certain resources or raw materials used in the manufacturing processes are secondary or recycled materials.

Recycled materials are those that have already been through a complete service life and are reintroduced as raw materials into a new cycle of production.

E.g.

- Concrete aggregate
- Cellulose flakes
- Recycled rockwool in the form of blocks
- Recycled glass used in the manufacture of fibreglass or cellular glass

It is important to stress that, in terms of sustainable resources management, these materials are extremely attractive insofar as they:

- Limit waste by reusing materials previously exploited;
- Recycle waste giving it fresh value (particularly economic value);
- They husband stocks of both energy and non-energy natural resources.

3.3.1.3. Energy resources

Each change and all processing requires energy: altering temperature, form and chemical composition etc. «Energy is nothing other than the unit of account for the transformation of the world around us».

Energy resources are used in the industrial construction sector as transport and processing fuel.

Indeed, the totality of industrial processes needed for the extraction of raw materials, manufacture of construction products, their transport, use, demolition and end of service life processing consume energy resources – to a greater or lesser extent according to the type of materials.

Energy that is consumed during the total life-cycle of construction materials is, currently, essentially produced from fossil fuels. The most widely-used fossil fuels are fuel oil, natural gas and coal.

The share of renewable energies (hydraulic, biomass, wind and solar power) in the manufacturing process is, on average, relatively low and of the order of 5% to 15% at best.

Certain industrial processes also use a greater or lesser quantity of waste, such as tyres or used oil etc.

As renewable fuels and fuels from recycled waste are still relatively marginal in the industrial construction sector, it is clear that this sector consumes a huge amount of fossil resources (45% of total energy consumption), thus driving overexploitation of these fossil resources. With current intensive use, these will be exhausted within six, or possibly just three, decades.

SUSTAINABLE REFURBISHMENT OF SCHOOL BUILDINGS

3. REDUCE NON ENERGY RESOURCES CONSUMPTION



Pictures: Sylvie Rouche

3.3.1.4. Resource availability

Availability of a resource indicates the quantity in which the material or resource is available in nature and whether or not its regular use is in balance with the available stock or with its natural regeneration.

Availability of resources is assessed differently according to whether one is referring to renewable or non-renewable resources.

→ Regeneration periods and rates

The term «regeneration period» is used for renewable resources, principally organic materials of vegetable or animal origin. The term «abiotic depletion potential» is used for non-renewables, such as mineral or synthetic resources.

The regeneration period of a resource corresponds to the time required for development of the material between each harvest or each shearing.

E.g.

Hemp and linen, used in particular as thermal and acoustic insulators, are harvested several times a year; their regeneration period is thus less than one year.

Bark of the cork oak, used as a thermal and acoustic insulator and for floor coverings, is harvested every 9 to 10 years (once the tree reaches the age of 15 years).

However, one must not confuse the regeneration period with the regeneration rate, which is defined as the relationship between the typical service life of a material and the regeneration period of the primary material from which it is made.

→ Abiotic depletion potential

The abiotic depletion potential (ADP) is based on the comparison of natural non-renewable abiotic resources and that of antimony (Sb).

Antimony is a chemical element of the pnictogen group. Its symbol is Sb and its atomic number is 51. It is a metalloid of metallic colour. Antimony is present in many minerals, often alloyed with the lead and in the form of an oxide or sulphide.

By convention, antimony has an ADP of 1. A value higher than 1 for a resource indicates that one is consuming a resource rarer than antimony. Conversely, resources with a very low ADP value (less than 0.001), are considered inexhaustible in human terms.

Examples (according to the ECOINVENT Database, in kg antimony equivalents) – per kilo of material:

- Gravel: 0.00002888 kg antimony e.
- Copper: 0.048696 kg antimony eq.
- Concrete: 0.56528 kg antimony eq.
- Cork: 0.0001415 kg antimony eq.
- Gold: 180 to 220 kg antimony eq.

The availability of resources and their preservation are major issues for sustainable development. It is essential, for sustainable resource management, to establish a link between actually existing stocks of resources on Earth and the present and future demands or needs that these stocks have to meet.

The availability of a resource is a useful indicator for raw materials from natural resources that are being employed for a first life-cycle in the manufacture of a material or product.

Conversely, this indicator cannot be used for recycled materials, because one does not have data regarding their availability comparable to the data on natural resources.

Note that the availability of recycled materials is still often unreliable and their supply is not always continuous.

SUSTAINABLE REFURBISHMENT OF SCHOOL BUILDINGS

3. REDUCE NON ENERGY RESOURCES CONSUMPTION



3.3.1.5. Sustainable exploitation of timber resources – FSC and PEFC certification schemes

Certain certification schemes give an assurance of sustainable conditions of exploitation. For wood-based materials (timber or timber products), this concerns in particular the FSC and PEFC certification schemes.

→ FSC certification scheme

FSC is the acronym for Forest Stewardship Council.

The FSC certification scheme is a private, membership organisation audited by an independent body.

Products bearing the FSC label contain wood from forests that obtained a certificate on the basis of their sustainable management. At the end of July 2007, 877 forests met the FSC standards and criteria. In total, this represented 89 million hectares of forest. The «FSC Pure» label may be used only when the product is composed of 100% FSC-certified materials. The «FSC Mixed» label indicates that the product is derived from a production process using FSC-certified material, recycled material or materials from other audited sources. The «FSC Recycled» label indicates that the product is made from 100% recycled material. The label applies only to the resources: it does not guarantee the subsequent stages of the production process.

The organisation that manages this certification scheme is the Forest Stewardship Council. This is an international organisation whose mission is to promote ecologically sound, socially responsible and economically viable management of the world's forests. The members of FSC represent environmental and social groups, the timber sector and trade, the paper industry, indigenous peoples and forestry groups throughout the world. The FSC label is recognised worldwide.

→ PEFC certification scheme

PEFC is the acronym for Programme for the Endorsement of Forest Certification Schemes. The PEFC label is awarded to a product containing at least 70% wood derived from sustainably managed forests. This is an international umbrella organisation based on mutual recognition of various national forest certification systems. 33 national systems are members of the PEFC and mutual recognition applies to 23 of them. Together these 23 systems have already certified more than 200 million hectares of forest. This makes the PEFC the largest certification scheme in the world for certification of forests (approximately 70% of the total certified area).

The PEFC certification scheme is private, mutual and audited. Auditing is carried out by independent and accredited certification bodies. The label can be used if the product contains at least 70% of PEFC-certified wood.

The PEFC label poses a problem for the consumer: it is impossible to know the exact provenance of wood labelled PEFC. This is a major problem, given that there are different systems of certification with different criteria in each country. Mutual recognition by various certification systems of variable quality, thus gives rise to a major lack of transparency.



3.3.2. The concept of grey energy

3.3.2.1. Definition of grey energy

When referring to grey energy in the construction materials industry and the construction sector, one must differentiate between «grey energy» and «embodied energy».

SUSTAINABLE REFURBISHMENT OF SCHOOL BUILDINGS

3. REDUCE NON ENERGY RESOURCES CONSUMPTION



→ Grey energy

Grey energy is calculated from primary energy and is given in MJ/kg of material produced. This energy can be divided into four types:

- **Primary renewable energy;**
- **Primary non-renewable energy (NRE);**
- **Material primary energy:** this energy takes into account the energy embodied in materials and theoretically recoverable at the end of their service life.
- **Process primary energy:** this takes into account the energy employed in processing, operation and transport of the material or system.

→ Embodied energy

Embodied energy is calculated from primary energy and is given in kWh/kg of material produced. Embodied energy is the energy required by a product's production process. It should be considered as the energy required for the process or, again, the energy consumed by the entirety of the processes connected with production of a product (even a building), from the extraction and processing of natural resources to the manufacture, transport and delivery of the products. Embodied energy does not take into account the implementation, maintenance and replacement during operational life and disposal of construction materials.

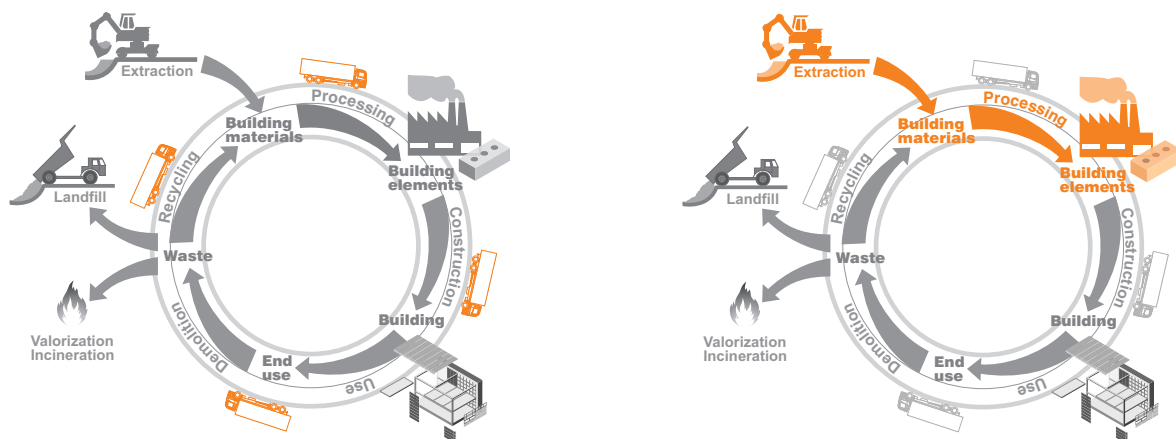

3.3.2.2. Relationship between grey energy and operational energy

Grey energy consumption must be set beside the operational energy consumed during the service life of a building.

In effect, in the construction sector, the past years have seen a desire to considerably reduce energy consumption associated with the use of buildings. In central Europe, this reduction in energy needs has been evidenced mainly through very efficient insulation and airtightness, enabling achievement of the «low-energy» standard or even, in the best cases, the German «Passivhaus» standard.

However, several research teams, including Architecture et Climat, have been able to demonstrate that while attention to the efficiency of the envelope tends to result in a noticeable reduction in energy consumption for use of the building, proportionally more materials, and thus more grey energy, are consumed as shown in the illustration (next page).

This grey energy thus becomes the dominant factor in the overall energy audit and must, therefore, be a paramount criterion in the choice of construction materials.

Explanation of the graph

The grey energy/heating energy comparisons are based upon a model of an individual house, according to four heating demand performance levels. (Source: Catherine Massart, Sophie Trachte)

- [D]: nearly 90 kWh/m² per year;
- [C]: 38 kWh/m² per year;
- [B]: 15 kWh/m² per year;
- [A]: 10 kWh/m². per year.

The heating system was assumed to have an overall efficiency of 80%. This is achieved with natural gas, with a global warming potential (GWP) of 231 g equivalent CO₂/kWh calorific value.

Each performance level corresponds to a particular thickness of insulation materials for each wall construction.

Two construction types were defined (solid and frame construction). For each of these types, according to the type of ball, the authors

SUSTAINABLE REFURBISHMENT OF SCHOOL BUILDINGS

3. REDUCE NON ENERGY RESOURCES CONSUMPTION



defined wall constructions with various materials. Two cases were used to define the walls:

- [↗] material with major global warming potential;
- [↘] material with minor global warming potential;

The comparisons were made over 50 years, taking into account replacement and removal of certain materials

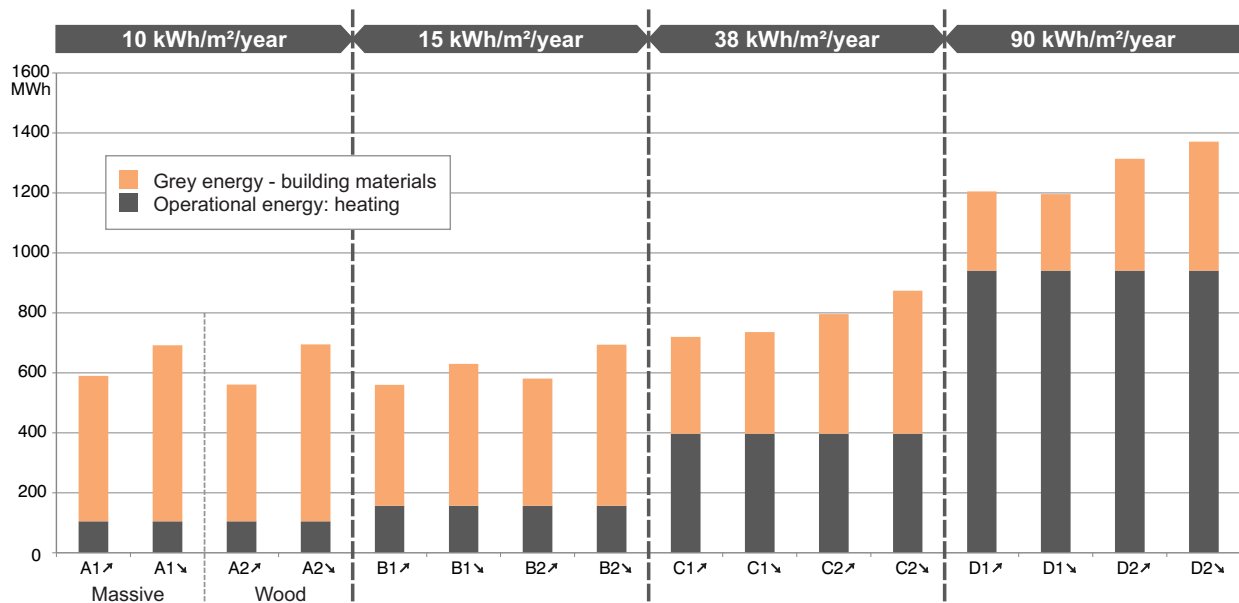

3.3.2.3. Relationship between grey energy and service life

In the industrial construction sector, certain manufacturing processes are also very energy intensive. These are essentially processes that require a major increase of temperature for a relatively long time. This particularly concerns industrial processes associated with cement, manufacture of fired-clay products and metal manufacture, but also with the manufacture of wood-based panels. This energy intensiveness must be set beside the materials' service life (more than 100 years for concretes, fired clay and metals).

E.g.

The total grey energy required for the manufacture of a fired-clay brick is 2.85 MJ/kg.

This value can be divided by the service life of the material (100 years). One thus obtains a value equivalent to 0.0285 MJ/kg.

The total grey energy for manufacture of a plaster render is 1.72 MJ/kg. This value can be divided by the service life of the material (30 years). One thus obtains a value equivalent to 0.0573 MJ/kg.

3.3.2.4. Fossil resources and raw materials

Oil and its derivatives are also, but to a lesser extent, used as raw materials in various manufacturing processes of construction materials: plastic materials, sealants, insulation, adhesives, paints and solvents.

These various materials were, for the most part, developed during the inter-war period and have now become indispensable both in our daily life and our construction methods.

Thus, it is paramount to conserve energy resources for production of these plastic or synthetic materials, rather than using them as fuel.

3.3.2.5. Grey energy-saving

Refurbishment of existing school buildings already represents a major grey energy-saving by comparison with construction of new buildings, as it allows:

- as a minimum, retention of the structure of the building, i.e. an economy of approximately 626 kWh/m³ of reinforced concrete retained;
- use to be made of existing networks/installations (electricity, gas, transport etc.);
- limiting the quantity of waste (by comparison with complete demolition and reconstruction).

SUSTAINABLE REFURBISHMENT OF SCHOOL BUILDINGS

3. REDUCE NON ENERGY RESOURCES CONSUMPTION



However, grey energy can be further reduced during refurbishment in the following way:

- through selection of energy efficient materials and construction products (as calculated over their whole life-cycle) that are sourced locally;
- through selection of materials and construction products with a long service life (>30 years) and with low maintenance requirements;
- through an interior layout of the buildings and premises that enables them to easily be adapted to future occupancy needs and to conversion.

Means employed for retaining the adaptability of buildings under refurbishment. The following means should be employed:

- preferring dry or demountable techniques;
- preferring frame or modular structures;
- preferring mechanical fixings that permit easier demounting;
- preferring exposed services;
- over-designing some facilities.

3.3.3. Environmental impacts of buildings materials

Extensive usage of materials, energy and construction materials has major consequences for the environment and for the health of both construction workers and building occupants. The environmental and health impacts must be considered over the total life-cycle of these inputs, from the extraction of raw materials required for manufacture up to the end of the product's service life.

3.3.3.1. Atmospheric pollution

Extraction of raw materials, manufacturing processes, installation on-site, end of service life treatment and transportation – essentially based on fossil fuels – processes that emit atmospheric pollutants of which the most important are carbon dioxide CO₂, sulphur dioxide SO₂, nitric oxides NO, volatile organic compounds VOCs, fine and very fine particles etc.

These various pollutants are responsible for major damage to the environment, such as global warming, acidification of air, water and soil, reduction of the ozone layer and production of tropospheric ozone.

→ Greenhouse effect – Global Warming Potential

The main greenhouse gases naturally present in the atmosphere are water vapour (H₂O), carbon dioxide (CO₂), methane (CH₄), nitrous oxide (N₂O) and ozone (O₃). Water, in the form of vapour or clouds, constitutes the largest quantity of greenhouse gas. It contributes 60% of the total greenhouse effect.

Other or anthropogenic greenhouse gases also play an important role, as the greenhouse effect produced by them is very intense. Other than the main gases already mentioned above, there are also fluorinated gases, such as the hydrofluorocarbons (HFC), chlorofluorocarbons (CFC), perfluorocarbons (PFC) and sulphur hexafluoride (SF₆).

Carbon dioxide (CO₂) is the main (with regard to quantity) greenhouse gas produced by human activity, 74% of the total (for all forms of emission combined).

Each greenhouse gas has a different effect on global warming.

E.g. over a period of 100 years, 1 kg of methane has a greenhouse effect 25 times stronger than 1 kg of CO₂.

To compare the emissions of each gas according to their impact on climate change, a reference unit is used, i.e. CO₂ equivalent. The CO₂ equivalent is also called the global warming potential (GWP). Carbon dioxide, which serves as the reference substance, has a value of 1. The global warming potential of a gas is given in terms of the mass of carbon dioxide that would produce an equivalent greenhouse effect.

E.g. methane has a GWP of 25, which means that it has a warming potential 25 times greater than carbon dioxide.

→ Acidification – Potential acidification

Since the 1970s, atmospheric deposition of sulphur has been designated as responsible for the dieback of some German and Scandinavian forests. 14,000 Swedish lakes are now affected by this acidification, resulting in considerable damage to vegetable and animal life.

It is now scientifically proven that anthropogenic discharges of oxides of sulphur (SO₂), oxides of nitrogen (NO_x), am-



monia (NH₃) and chlorine (HCl) into the environment all have an acidifying effect on natural soils and waters. These substances, transported long distances in the atmosphere from their place of emission, form a diffuse and cross-border pollution. Atmospheric acidification is, thus, a regional and/or continental phenomenon and not a global phenomenon like global warming.

Anthropogenic nitrogen is discharged into the atmosphere essentially in the form of nitrogen oxides (NO_x) produced by the combustion of fossil fuels, ammonia (NH₃) used in agriculture as a fertiliser or produced by livestock, as well as nitrous oxide (N₂O) and nitric oxide (NO) produced by microbial transformation of nitrogen fertilisers.

Acidification Potential or potential for atmospheric acidification

To determine a contribution to atmospheric acidification, one determines an acidification potential (AP) value in SO₂ kg equivalent. Sulphur dioxide (SO₂), which serves as reference substance, has a value of 1. The overall acidification potential of a gas is the factor by which its mass must be multiplied to obtain a mass of SO₂ that would produce an equivalent acidification effect.

Type of pollutant	Formula	GWP	Carbon Equivalent(per kg emitted)
Water vapour	H ₂ O	8	2,18
Carbon dioxide	CO ₂	1	0,273
Methane	CH ₄	25	6,82
Nitrous oxide	N ₂ O	298	81,3
Dichlorodifluoromethane	Cl ₂ F ₂	6200 to 7100	1690,74
Tetrafluoromethane	CF ₄	6500	1772,55
Sulphur hexafluoride	SF ₆	22 800	6217,56

GWP and Carbone Equivalent of various atmospheric pollutants - Source: IPCC, 4th Assessment report (2007)

→ Eutrophication – Eutrophication Potential

Eutrophication is an environmental phenomenon that was initially described for surface waters and coastal waters. This local phenomenon corresponds to an increase in the growth of algae (followed by their rotting) which leads to partial or total loss of oxygen in the aquatic environment. This is the outward sign of the imbalance which results from an excessive supply of nutrients, in particular nitrogen (contained in ammonia, nitrates and nitrites) and phosphorus (contained in phosphates). This imbalance is nonetheless accelerated by anthropogenic discharges of nutrients originating from agricultural applications of sprays and soil additives excessively rich in fertiliser (nitrogen and phosphorus) and anthropogenic discharges rich in nitrates, ammonia and untreated organic matter.

Eutrophication is observed especially in ecosystems with slow water replacement and, in particular, in deep lakes. Coasts and estuaries are not spared, as their waters are relatively undisturbed and receive many discharges emanating from human activity.

The concept of eutrophication of water has been extended to land-based ecosystems. This phenomenon causes a problem of loss of biodiversity at the same time as one of increasing vulnerability of ecosystems to acidifying depositions, parasites and bad weather. Eutrophication of land is generally caused by excessive applications of nitrogen and by its accumulation in the ecosystem. It has the effect of modifying the existing flora, to the profit of species that prefer to grow in nitrogen-rich environments. These species become dominant and, thus, progressively take over the available space and light. Eventually, one observes the disappearance of species and a loss of biodiversity.

→ Destruction of the ozone layer – Ozone Depletion Potential

For several decades, every year, during springtime in the southern hemisphere, chemical reactions involving bromine and chlorine have been causing rapid and severe destruction of the ozone layer in the southern polar region. The shrinking of this layer is known as the «ozone hole». The largest reductions have been observed in the polar regions, in particular the Antarctic, during the coldest periods. These reductions are due to emissions of certain atmospheric pollutants associated with human activities. The cause is the emission of chemical substances: chlorofluorocarbons (CFCs) and halons, mainly used in the refrigeration industry, in aerosol canisters, in solvents for the electronics industry, in synthetic foams and extinguishing agents.

The stratospheric ozone layer is essential for life on Earth, because it protects from dangerous ultraviolet rays (UV) emitted by the sun. Over exposure to ultraviolet rays can produce harmful effects on health and on the environment:

- Health effects: in the short term, an increase in sunstroke and superficial burns; in the long term, an increase in illnesses and skin cancers, weakening of the immune system and increase of eye problems;

SUSTAINABLE REFURBISHMENT OF SCHOOL BUILDINGS

3. REDUCE NON ENERGY RESOURCES CONSUMPTION



- Environmental effects: reduction of photosynthesis and slowing of plant growth, loss of plankton and reduction of immunity to infectious diseases, causing a decrease of biodiversity in the long term.

Each of these chemical substances has a different effect on the shrinking of or damage to the ozone layer in the upper atmosphere, known as the Ozone Destruction Potential. This scale is intended to classify the damaging effect of the action of various gases – principally the chlorofluorocarbons (CFCs) – on the ozone layer.

The reference substance for this scale is trichlorofluoromethane (CFC-11), which has the destructive potential index value of 1.0. This potential is, thus, for a compound other than CFC-11, the ratio of the global ozone depletion due to that compound to the global ozone depletion caused by the same mass of CFC-11.

Most CFCs have an ODP close to 1:

- Bromine compounds have a higher ODP (generally between 5 and 15) because of bromine's greater reactivity with ozone;
- Hydrofluorocarbons (HFCs) have a lower ODP (between 0.005 and 0.2) because of the presence of hydrogen which renders them reactive in the troposphere.

→ Photochemical creation of ozone – Photochemical Ozone Creation Potential

In contrast to the risk of destruction of the stratospheric ozone layer, the quantity of ozone contained in the troposphere (0-12 km altitude) has increased by a factor of five in the northern hemisphere since the end of the last century, under the effect of anthropogenic pollution mainly emitted by road and air traffic, industries, thermal power stations etc.

This development has major consequences for health, plant life and the greenhouse effect.

On sunny days, solar radiation causes chemical reactions in the atmosphere involving the primary pollutants, also known as precursor gases, such as nitrogen oxides (NO and NO₂, collectively known as NO_x) and volatile organic compounds (VOCs). These complex chemical reactions give rise to photo-oxidants. In our regions, the best-known of these is ozone (O₃), a molecule made up of three oxygen atoms. The phenomenon is known as the «ozone peak» and is quite frequent in the summer period, because in summer the stability of the mass of air limits the dispersal of pollutants.

The Photochemical Ozone Creation Potential (POCP) of a chemical compound is the theoretical additional formation of ozone in the troposphere compared with the baseline situation. The purpose of this scale is to grade the impact of the various precursor gases, principally nitrogen oxides, carbon and the VOCs - on the formation of ozone in the lower layers of the atmosphere.

The reference substance for this scale is ethylene (C₂H₂), which has an ozone formation potential of 1.0.

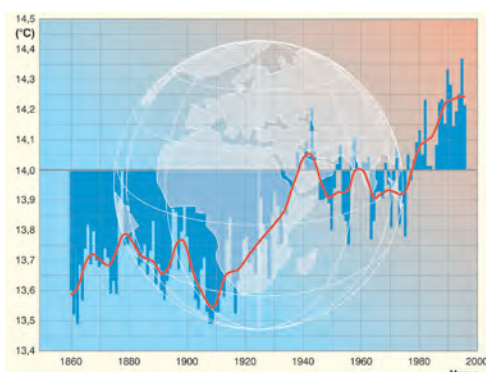

Global Warming since 1860

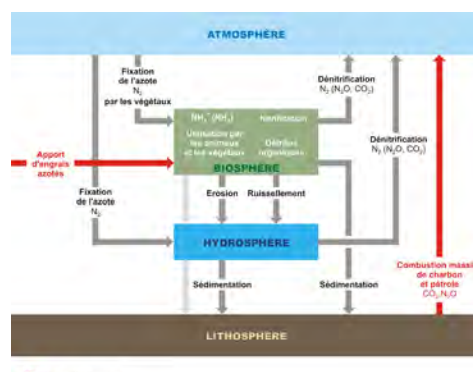

Cycle of azote

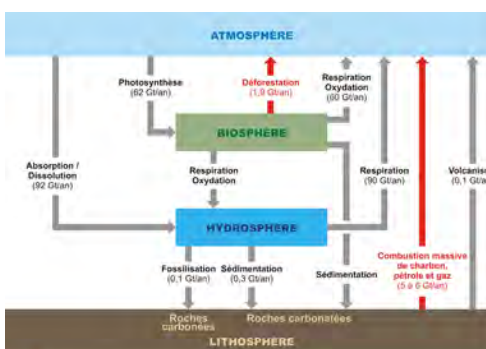

Cycle of carbone

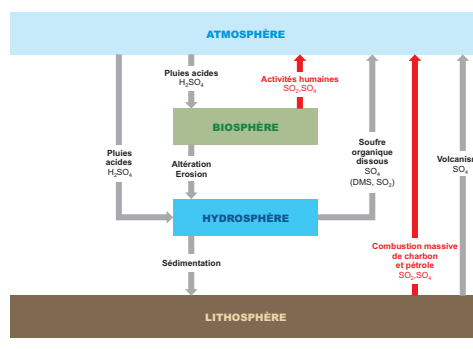

Cycle of sulphur

SUSTAINABLE REFURBISHMENT OF SCHOOL BUILDINGS

3. REDUCE NON ENERGY RESOURCES CONSUMPTION



In order to limit the emission of atmospheric pollutants (associated with the industrialisation of construction materials), the use of the following is preferred:

- Local materials and/or materials transported by means of transport causing little pollution;
- Materials whose manufacturing process does not use, or uses only a low quantity of substances harmful to the environment;
- Timber or plant-origin products, if they are sourced from sustainably managed forests and cultivation;
- Materials whose manufacturing process uses renewable energies (biomass, solar, hydraulic).

3.3.3.2. *Impact on the landscape and biodiversity*

The use of certain raw materials or materials can have damaging consequences for the landscape, biodiversity and existing ecosystems. This is particularly the case for timber production, which can, when it is not sustainably managed, entail the deforestation of large areas of forest. This is also the case for some quarrying of aggregates or stone materials or for some extraction of minerals or metals etc.

In order to limit the impact on the landscape and biodiversity, the use of the following is preferred:

- Timber or plant-origin products, sourced from sustainably managed forests and cultivation;
- Stone materials sourced from Belgian or European quarries, subject to strict regulation in terms of environmental friendliness;
- FSC or PEFC-certified timber and timber products;
- Materials manufactured from recycled materials.

3.3.3.3. *Waste production*

Manufacturing, implementation and demolition inevitably involve waste production. If most construction waste is currently, intrinsically recyclable, most of it, for lack of technical means or the difficulty of disassembly and sorting (during demolition), is still treated in the traditional way by incineration or by taking it to an industrial landfill site. These traditional channels of waste treatment have a not inconsiderable impact on the environment (atmospheric pollution, risk of pollution to soil or water resources etc.) and are often costly. Their operation will be limited in the coming years (according to European standards).

E.g.

Inert materials (concrete, bricks etc.):

- Average cost of recycling: € 8.5 per tonne (source: MEDECO)
- Average cost of putting into industrial landfill: € 10 per tonne (source: MEDECO)

Manufacture of aluminium from extracted raw materials:

- 116.1 MJ/kg (source: ECOSOFT)

Manufacture of aluminium from recycled aluminium waste:

- 19.5 MJ/kg (source: ECOSOFT)

In order to limit construction waste production the following are to be preferred:

- During the design phase:
 - production of accurate bills of quantities and plans, so as to correctly assess the quantities of materials to be used;
 - use of prefabricated materials, of standardised sizes and/or in bulk, in order to limit on-site cutting and offcuts;
 - the use of recyclable and actually recycled materials.
- During the works phase:
 - sorting of waste produced by demolition and construction works. removal of waste to recycling facilities;
 - mechanical fixings and joints, enabling easier subsequent dismantling and facilitating sorting.

SUSTAINABLE REFURBISHMENT OF SCHOOL BUILDINGS

3. REDUCE NON ENERGY RESOURCES CONSUMPTION



3.3.3.4. Impact on health

«Children are our future and the future of sustainable development begins with safeguarding the health of our children»
Kofi Annan, UN secretary general, 2003.

The quality of the air we breathe, whether indoors or outdoors, is a factor that noticeably affects our health.

According to the World Health Organisation (WHO):

- air pollution is a major environmental risk to health. By reducing air pollution levels, we can help countries reduce the global burden of disease from respiratory infections, heart disease, and lung cancer.
- the lower the levels of air pollution in a city, the better respiratory (both long- and short-term), and cardiovascular health of the population will be.»

If in developing countries, many deaths can be attributed to unhealthy environments (poor water quality, malaria, inadequate sanitation, severe indoor air pollution from cooking and heating smoke etc.), the Western countries are mainly affected by allergies and cancers, which affect the whole population, including a large number of children.

Thus, the European project EnVIE showed the influence of poor air quality on the incidence of illnesses.

The example of Belgium:

Each year, in Belgium, 12,000 cases of asthma as well as 10,000 cases of cardiovascular illness, 3000 cases of lung cancer or 12,000 cases of SBS (sick building syndrome) are due to poor indoor air quality. The study shows that over all the above-cited pathologies in Belgium, 7000 cases per year have their origin in the presence of excessive concentrations of VOCs.

Whether through handling raw materials and construction materials, or during our daily activities in our indoor and outdoor environments, we are permanently in direct contact with physical and chemical pollutants.

These physical and chemical pollutants are partly given off by the materials themselves and partly present in the air we breathe. In both cases, these pollutants can cause problems ranging from simple irritation of the hands or eyes (during handling), to irritation of the respiratory tract, whose effects can range from temporary ones to permanent respiratory impairment or chronic illness.

The lungs and respiratory system are the first target of these pollutants. In fact, our lungs represent a surface of nearly 90 m² that comes into contact every day with approximately 15 m³ of air, i.e. nearly 20 kg, while daily ingestion of water is only approximately 2 kg and of food between 1 kg and 2 kg.

In this section, we shall not touch upon either electromagnetic pollution or pollution by bio-contaminants. Electromagnetic pollution comprises electrical and magnetic fields present in our environment and due to human activity. By bio-contaminant, we mean a pollutant of biological origin. Occupation of a dwelling generates this type of pollutant through the presence of people, animals, plants and vegetable matter, mites etc.

This field of research is relatively new and complex. Many unknowns remain, especially with regard to harmful raw materials introduced in manufacturing processes or installation and use, how they react within the material, how they react to a higher or lower level of humidity, the quantity at which these substances become actually harmful to health etc. An in-depth study would require:

- Technical data on the materials' composition and the concentration of toxic substances;
- Scientific data regarding emissions specific to each type of construction material (primary pollutants) and to a totality of materials made up into walls (type of pollutants, quantity omitted, emission period etc.);
- Scientific data on the potential for creation of secondary pollutants given the presence of several primary pollutants and the hygrothermal context.

Emissions of primary pollutants are caused by the components of materials.

According to doctors Suzanne and Pierre Déoux, these emissions are at a high level immediately after manufacture, diminishing by 60% to 70% during the first six months and generally disappearing a year after construction or use.

Most manufacturing processes use many toxic substances, such as heavy metals (lead, cadmium, mercury, zinc and arsenic), biocides, fungicides, certain solvents (toluene, benzene and xylene), volatile organic compounds (VOCs) (formaldehyde) and certain additives (flame retardants etc.).

These substances are mainly found in the finishing materials and finishes, such as wood treatment products (preservation and finishes), varnish and paints, waterproofing materials and sealants, adhesives, some renders, some floor coverings (fitted carpet, vinyl etc.).

Moreover, installation and use of certain materials, such as mineral-based insulation, can cause their dispersal in the air and inhalation of fibres. These are classified as Category 3 by the European Union (possible carcinogenic effects, but not adequately assessed) and can cause irritation of the skin, eyes and respiratory tract (demonstrated risks) and, potentially, can cause respiratory illness or even cancer of the respiratory tract.

SUSTAINABLE REFURBISHMENT OF SCHOOL BUILDINGS

3. REDUCE NON ENERGY RESOURCES CONSUMPTION



These chemical substances have a considerable effect on the health of living creatures and the environment. This is why there are now European regulations enabling the registration, assessment, authorisation or restriction of use of certain substances. This involves the following regulations:

- **REACH:** Regulation (EC) No. 1907/2006 of the European Parliament and Council of 18 December 2006. The European REACH regulation requires manufacturers and importers of chemical substances to evaluate the risks arising from their use and to take the necessary measures to manage all identified risks. REACH makes industry responsible for assessing and managing the risks posed by chemical products and for furnishing adequate safety information to users.
- **CLP:** Regulation (EC) No. 1272/2008 2243 of the European Parliament and Council of 16 December 2008 on classification, labelling and packaging of substances and mixtures. The CLP regulation also sets the regulatory framework for the classification, packaging and labelling of dangerous chemical substances and products. Its purpose is to ensure the protection of people (who may come into contact with them) and of the environment. The classification allows identification of hazards that the chemical products may present due to their physico-chemical properties, their effects on health and on the environment.

In order to limit the impact of materials on health, the following should be prioritised:

- Surface treatments (preservation and finishes) with water-based or suspension-based materials, without volatile organic compounds (VOCs) and that permit easy maintenance without the use of harmful products;
- Finishes (floor, wall and ceiling) of natural origin all minimally processed, that can be installed by mechanical fixings, without involving sources of allergens, radioactive emissions (e.g. some plasters or renders), not containing biopersistent fibres (present in some insulation materials) and permitting easy maintenance without the use of harmful products;
- Certificated materials, especially adhesives, paints, thin floor coverings and wood treatment products etc.

The use of fibrous materials that can entail a potential risk for the installer and user shall be limited. Proper and sufficient ventilation of indoor areas shall be allowed for.

3.3.4. Materials selection: goals and action during refurbishment

For sustainable construction, responsible and public-spirited choice of materials or construction products means taking the following into account for their whole service life:

- A technical and/or physical performance audit;
- An environmental audit;
- An energy audit;
- A health audit (workers and occupants);
- An economic audit.

Carrying out these five audits is not easy, mainly because of the lack of objective and quantifiable data for the environmental and health audits. For this reason, this section is written with the goal of defining actions and guidelines that will enable the limiting of environmental and health impacts of construction materials and techniques.

3.3.5. Guiding principles for the selection of materials and construction methods

Nowadays, planning a building refurbishment must be done while taking into account the future life-cycle of the building and conducting an analysis, from the design phase onwards, of the new programming, the spatial arrangement, particular new construction methods (in the case of an extension or major refurbishment) and selection of materials. This should be carried out in a way that gives preference to a potential for development and that facilitates future changes, all the while minimising environmental and health impact.

The goal is to give the building and its components an extended service life. This idea covers two complementary spheres of action:

- In terms of the building: the concept of being evolutive and flexible, aiming for adaptability of the building to changing needs.
- In terms of materials: promoting the life-cycle and selection of materials, promoting the capacity for disassembly and processing or redevelopment.

SUSTAINABLE REFURBISHMENT OF SCHOOL BUILDINGS

3. REDUCE NON ENERGY RESOURCES CONSUMPTION

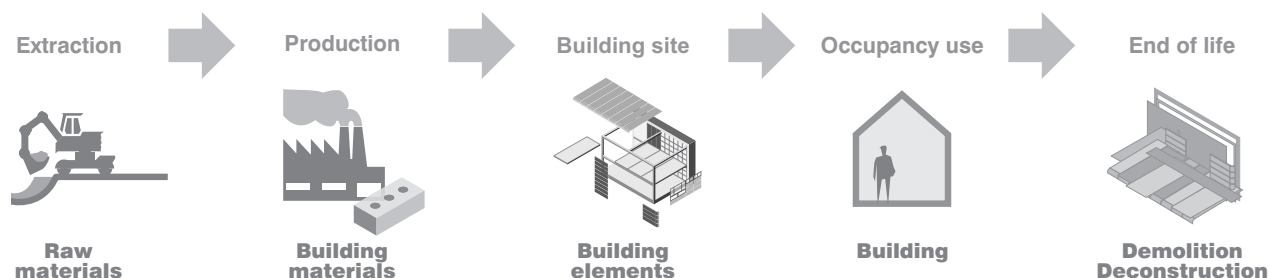

This is why the principles proposed below apply on two different levels: selection criteria linked to the service life of the building and selection criteria linked to the service life of the actual materials.

In terms of the building to be refurbished, the following principles can be proposed.

3.3.5.1. Rationalising the use of construction materials during refurbishment

Here, we can take up the maxim of Ludwig Mies van der Rohe that «less is more», in order to clearly express this principle of rationalisation. Mies van der Rohe used that phrase to express his enthusiasm for and attraction to minimalism.

We shall use this expression in its initial sense, i.e. those materials which do not have any impact on the environment and health cannot be installed, used or manufactured. In terms of rationalisation of materials, several principles can be stressed that will guide the design process.

→ First Principle

The first principle is to suit the selected construction method to the service life of the building within which the system is used. In fact, the service life of the building can vary according to the proposed use of the building, its location and changing needs. The materials selected must, thus, have a service life suited to that of the building or at least approaching it.

In the case of a building with a short service life (5 to 20 years), the designer will prefer demountable construction techniques and construction materials that are easily taken apart. These techniques allow easy dismantling and/or evolution of the building, while limiting the environmental impact.

→ Second Principle

The second principle, which is complementary to the first, is the choice of a construction method that permits evolution, flexibility and/or adaptability of structures in a way that increases their service life. The adaptability of the building means its capacity, without changing either its use or the services it provides, to undergo change at minimal environmental cost (raw materials, energy, waste and discharges).

→ Third Principle

The third principle is to encourage mechanical techniques for assembly and fixings, which enable factory prefabrication or pre-assembly, particularly for finishing and claddings. In fact, these various techniques offer the following advantages: rationalisation of the quantity of materials used, reduction of transport to the construction site, reduction of waste produced on-site, potential improvement of the performance qualities of prefabricated components, improved working conditions for the construction workers, optimisation and control of the assembly processes, speed of on-site work (mainly limited to assembly of major components), cost savings thanks to increased control of fabrication processes and the reduced need for on-site labour etc. Prefabrication will also have the advantage of developing dry construction, which not only allows freedom from the constraints of weather conditions, but also the reduction of on-site water consumption.

→ Fourth Principle

The fourth principle is optimising the design of construction components by using standardised, commercial sizes. This principle is more difficult to apply to refurbishment, where existing dimensions must be observed.

→ Fifth Principle

The fifth and final principle of rationalisation is to prefer the use of raw-finished materials, limiting the use of finishing materials and finishes. Indeed, finishing materials and finishes are becoming more and more complex, combining numerous substances and additives. They are thus liable to emit more pollutants and to have more negative effects on the quality of indoor air and human health. Leaving materials with a raw finish also means maximising their potential for recycling

SUSTAINABLE REFURBISHMENT OF SCHOOL BUILDINGS

3. REDUCE NON ENERGY RESOURCES CONSUMPTION



by avoiding mixing them with other materials. This type of finish, however, requires a very high quality of on-site work because no additional coating will be used to hide any defects.

3.3.5.2. *Optimising maintenance and maintaining performance during the building's service life.*

Once they are operational, the materials or construction components must fulfil their function for as long as possible without reduction in performance. Three selection principles associated with maintenance and maintaining performance can be highlighted.

→ **First Principle**

The first principle is to optimise the compatibility of materials and construction systems with the use or function they have to fulfil. Construction materials must first of all be chosen for their performance according to the use and demands that will be made upon them.

The choice of an external cladding will, for example, be made according to its resistance to outdoor climate conditions. Materials in contact with the indoor environment will be selected according to their resistance to shock, humidity or even the presence of particular products etc.

→ **Second Principle**

The second principle is to choose materials with a long service life and that need little or no maintenance.

→ **Third Principle**

The third and final principle complements the second and it is to facilitate the upkeep, repair and/or replacement of construction components. All construction components, particularly facade components (cladding, solar protection, safety rails, thresholds etc.) and components in contact with the indoor environment (floor, wall and ceiling coverings), must be easily accessible to allow their upkeep, maintenance or repair without major work, without disturbance to the occupants and without altering auxiliary components. The same applies to technical installations.

3.3.5.3. *Optimising the end of refurbishment life: facilitating deconstruction, encouraging sorting and re-use.*

The end of life of construction materials is an important phase in the service life, especially with the goals of, on the one hand, reducing resource consumption and, on the other hand, minimising the production of waste that needs treatment.

The end of life phase comprises two stages: demolition (or deconstruction) and what is done with waste. Deconstructing a building, i.e. its dismantling or disassembly, offers the advantage of facilitating on-site sorting and thus allowing a better use of waste. If waste is correctly sorted, it can be more easily reused and/or made use of in recycling facilities.

Optimisation of the end of life of certain parts or components of a building, during refurbishment, can be achieved by following two principles.

→ **First Principle**

The first principle is to facilitate the deconstruction or dismantling of components by anticipating – during design and when drawing up the construction file – selective demolition of the building: As-Built plans, user and maintenance file, as-built technical details, accurate inventory and bill of quantities of materials used (potential waste) as well as the technical sheets. This principle applies more to reconstruction or new construction, but can also be integrated into some refurbishments.

→ **Second Principle**

The second principle is to encourage the re-use of materials, particularly in the context of refurbishment projects.

The question that should be asked each time, when considering a component, product or material that one would like to get rid of, is no longer «Is it still fashionable, isn't it out of date?» but «What is the amount of labour invested in it, what is the quantity of matter, energy and labour that I will economise, what is the quantity of waste avoided?»

Once the question is posed, one realises that, except in the event of major technical obsolescence and setting aside masonry and reinforced concrete components, every construction component can be reused.

With regard to selection of materials during refurbishment, the following environmental and health criteria can be proposed below:

SUSTAINABLE REFURBISHMENT OF SCHOOL BUILDINGS

3. REDUCE NON ENERGY RESOURCES CONSUMPTION



3.3.5.4. *Limiting depletion of resources by employing three courses of action: economy of materials, selection and sourcing of materials and re-use of materials.*

→ **First Principle**

The first principle is to select materials originating from the re-use and recycling sector prioritising the re-use or recycling of materials coming from other sites or workplaces being deconstructed or refurbished or by prioritising the use of materials from recycling facilities.

If the designer opts for the re-use of materials, the technical advisers must be quickly informed, because this choice may have implications for performance achieved by components and the building as a whole, as well as on the design of technical components (lighting, radiators).

Encouraging the use of materials from recycling facilities can be done either by using materials whose manufacturing process uses a high percentage of recycled materials (cellulose flakes, glass-fibre, cellular glass etc. for insulation), or by using highly recyclable materials (steel, metals, concrete, bricks etc. for the building carcass).

In all cases, it is indispensable to be familiar with effective recycling facilities: there is no point in using highly recyclable materials if there are no such facilities or they are extremely distant (i.e. not nearby in Europe).

For their part, designers, when selecting construction materials for implementing their renovation projects, may also encourage or facilitate materials recycling by:

- using homogeneous materials i.e. materials that have not been subject to chemical transformation;
- favouring non-composite materials (avoiding several layers of different materials assembled by glueing);
- favouring easily demountable materials.

→ **Second Principle**

The second principle is to use materials derived from renewable resources with a high regeneration rate and/or materials derived from non-renewable resources but present in large quantities and available without major technical intervention (extraction). This principle aims to limit, as far as possible, overexploitation of particular resources and, thus, to limit impacts on the environment and biodiversity.

→ **Third Principle**

The third principle is to choose materials that have undergone little or no processing during the production stage. In fact, the more complex the manufacturing process, the more processing it requires, the greater its environmental impact in terms of energy consumption and atmospheric pollution. Thus, preference should be given to finished products of materials that remain close to the original raw material. This principle also facilitates making use of and recycling materials at the end of their service life.

→ **Fourth Principle**

The fourth principle is to select construction materials according to their origin or geographical provenance taking into account the means of transport used. If the distance covered by construction materials influences their environmental audit, the mode of transport used to travel that distance is also a significant element of the environmental audit.

Designers should, therefore, take care to choose materials that are local, regional or from nearby countries, as far as possible limiting road transport. They should also prefer direct routes from the factory.

During demolition, designers should also take care to identify the treatment and/or recycling facilities in the proximity of the site.

→ **Fifth Principle**

The fifth and final principle of the resources economy is to give preference to materials having only a slight impact on the consumption of grey energy, by selecting, for the same function and equivalent performance, a material which, for the totality of the stages of its service life, is grey energy efficient i.e. renewable and non-renewable grey energy.

When comparing several construction products, fulfilling the same function in an equivalent way, account should be taken of products or components which maximise the use of renewable energies in their manufacturing process.

3.3.6. **Environmental impact, ecological audit and environmental assessment tools**

In the context of sustainable refurbishment of a school, selection of construction materials must be performed on the basis of a multi-criteria analysis of:

SUSTAINABLE REFURBISHMENT OF SCHOOL BUILDINGS

3. REDUCE NON ENERGY RESOURCES CONSUMPTION



- Physical and technical characteristics
- Their environmental audit;
- Their impact on the health of both construction workers and occupants;
- Their economic cost.

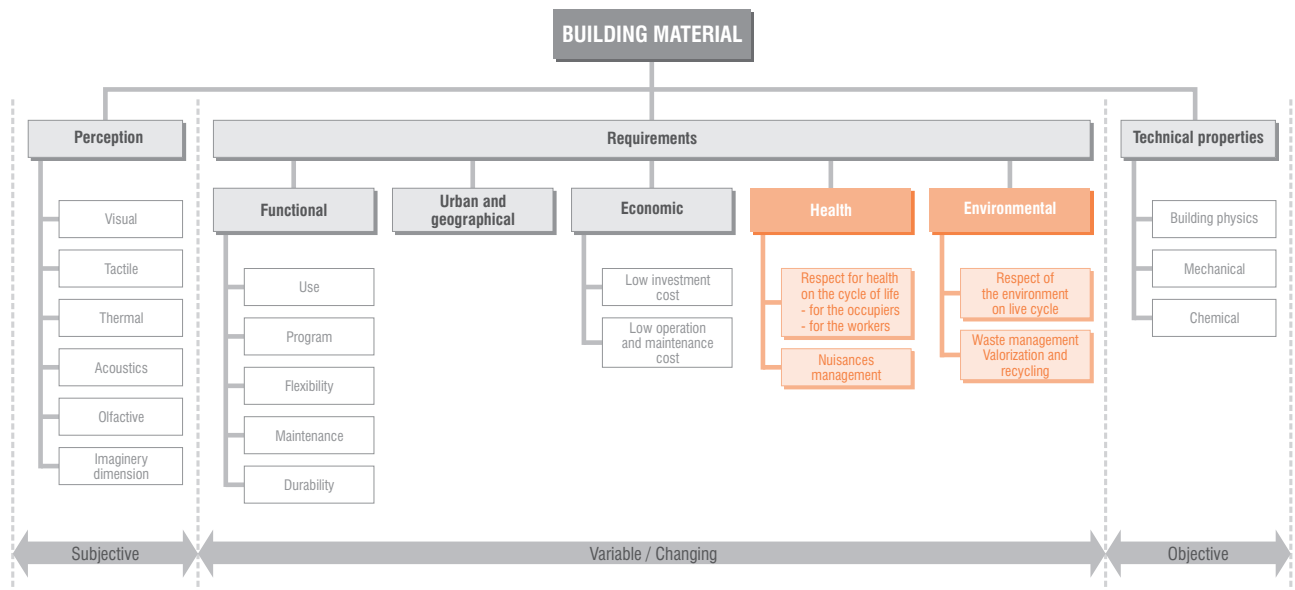

Source : Sophie Trachte, *Matériau, matière d'Architecture Soutenable*, Phd Thesis, juin 2012

3.3.6.1. Eco-audit and life-cycle analysis

The environmental audit, eco-audit or life-cycle analysis (LCA) is a complex study permitting quantification of a product's environmental impacts from the extraction of the raw materials it is made from until disposal at the end of its service life, including the distribution and utilisation stages.

The totality of these successive stages is defined by a cycle i.e. a sequence of transformations undergone by the materials throughout their service life.

This idea of a cycle is variable and depends upon the number and type of stages considered:

- The cradle to gate cycle includes the stages of extraction, transportation and manufacture or production. The cycle ends with the finished product leaving the factory;
- The cradle to grave cycle includes all stages from extraction to the end of service life, taking into account the various transportation stages;
- The cradle to cradle cycle includes all stages from extraction to the end of service life including the transport stages and the recycling stage when the waste material is considered to be a raw material for a new cycle of production.

The LCA applies only to a product as such. It studies the product and its function and thus enables comparison between products for a given function.

3.3.6.2. Environmental assessment tools

Numerous tools permit the environmental assessment of construction materials for a wall comprising several types of materials or for an entire building.

Architects and project owners can use these tools to help them optimise their selection of materials and construction methods.

There are numerous tools on the European market, but most of them generally apply to the priorities of a more restricted sector (region or country) in terms of construction choices or materials production.

As a reminder, it is important, when wanting to use one of the tools listed below to understand:

SUSTAINABLE REFURBISHMENT OF SCHOOL BUILDINGS

3. REDUCE NON ENERGY RESOURCES CONSUMPTION

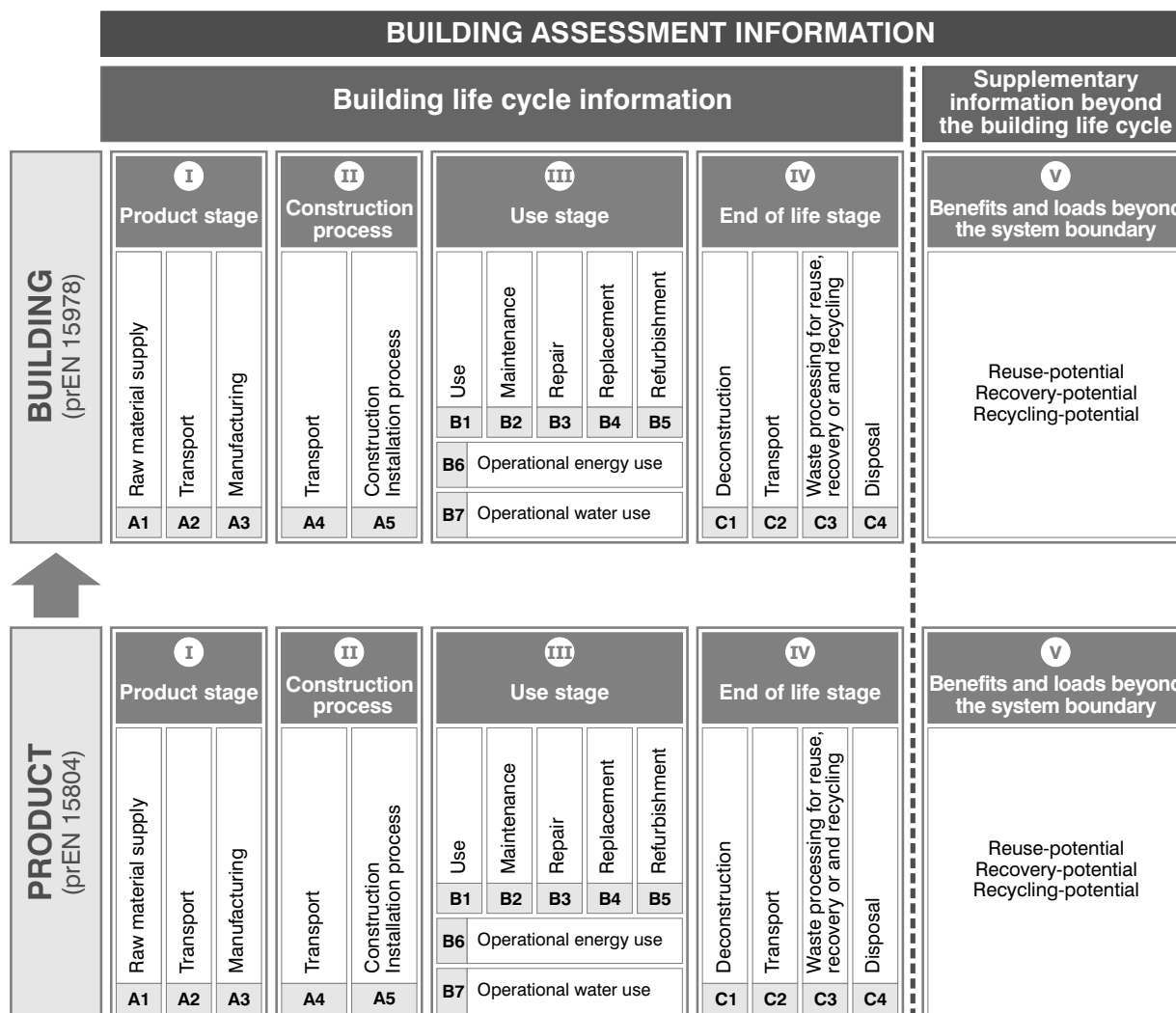

- The limits of the analysis;
- The databases used for the analysis;
- The environmental and health criteria taken up by the analysis;
- The weighting of criteria, if any.

→ The product's environmental declarations

The product's environmental declarations are the declarations that the manufacturers are responsible for making for construction products according to the Standard ISO 14025.

These declarations are information sheets – verified by an independent third party – in which the manufacturer furnishes, on the basis of a life-cycle analysis, quantitative data regarding the impact of their product on the environment throughout its life-cycle (cradle to grave) or for the first stages of the life-cycle (cradle to gate).

The information sheets can also include other aspects, such as a warning against certain toxic or dangerous substances or information about particular components.

Several European countries have legislated on the subject according to Standard ISO 14025. This is particularly the case for France, but also for Germany, Switzerland, Britain, the Netherlands etc.

These various countries have brought together all the EPDs on Internet portals accessible to the general public.

- INIES database for France: <http://www.inies.fr>
- IBU (Institut Bauen und Umwelt) database for Germany: <http://www.bau-umwelt.de>

SUSTAINABLE REFURBISHMENT OF SCHOOL BUILDINGS

3. REDUCE NON ENERGY RESOURCES CONSUMPTION



- SIA (Société suisse des Ingénieurs et Architectes) database for Switzerland: <http://www.sia.ch>
- BRE (Building Research Establishment) database for Britain: <http://www.bre.co.uk>
- MRPI (Milieu Relevant Product Informatie) database for the Netherlands: <http://www.mrpi.nl>

Comment:

Environmental product declarations (EPDs) for construction products are in the course of harmonisation under Standards ISO 21930 and EN 15804. In fact, according to the methods and tools used, the type of information as well as how detailed it is can present major variations from one product to another.



Institut Bauen
und Umwelt e.V.

1	Consommation de ressources énergétiques			
	Energie primaire totale (MJ)	1,200E+000	1,200E+002	
	Energie renouvelable (MJ)	2,000E-001	2,000E+001	
	Energie non renouvelable (MJ)	1,000E+000	1,000E+002	
	Energie primaire procédé (MJ)	Non renseignée	Non renseignée	
2	Epuisement de ressources (ADP) (kg eq. Antimoine)	3,700E-004	3,700E-002	
3	Consommation d'eau totale (L)	3,230E-001	3,230E+001	
4	Déchets solides			
	Déchets valorisés (total) (kg)	2,710E-002	2,710E+000	
	Déchets éliminés			
	Déchets dangereux (kg)	4,360E-005	4,360E-003	
	Déchets non dangereux (kg)	7,160E-003	7,160E-001	
	Déchets inertes (kg)	4,190E-001	4,190E+001	
	Déchets radioactifs (kg)	5,730E-006	5,730E-004	
5	Changement climatique (kg eq. CO2)	1,050E-001	1,050E+001	
6	Acidification atmosphérique (kg eq. SO2)	3,450E-004	3,450E-002	
7	Pollution de l'air (m³ d'air)	9,190E+000	9,190E+002	
8	Pollution de l'eau (m³ d'eau)	5,960E-002	5,960E+000	
9	Destruction de la couche d'ozone stratosphérique (kg eq. CFC)	0,000E+000	0,000E+000	
10	Formation d'ozone photochimique (kg eq. éthylène)	3,130E-005	3,130E-003	

Source: www.inies.fr

Source: www.sia.ch

Source: www.bre.co.uk

→ Environmental labels

Environmental labels are considered as markings regulated by Standard ISO 14024.

The label can be considered as a communication tool to architects, designers or project owners. The manufacturers highlight certain environmental or health qualities of their products.

A label can be considered reliable under the following conditions:

- The evaluation criteria must be included in the standard and must be verifiable;
- The methodology used for the evaluation must be transparent. All information, including that about criteria and specifications, must be available upon demand;
- The whole of the procedure (criteria and methodology) must be monitored by an independent and approved monitoring body;
- Labelling must be mandatory.

There are various types of certification schemes:

- **Official certification schemes** managed by an authority. Monitoring is carried out by independent, external organisations, which are usually accredited. This accreditation guarantees the reliability and quality of monitoring. These are voluntary systems: only manufacturers who wish to do so label their products.

SUSTAINABLE REFURBISHMENT OF SCHOOL BUILDINGS

3. REDUCE NON ENERGY RESOURCES CONSUMPTION



- **Private, mutual certification schemes**, managed by a sector of industry, a professional association or an association considered to be independent of the manufacturer or sector. Monitoring is performed by independent, external organisations, which are usually accredited. These too are voluntary systems.
- **Private certification schemes, individual and monitored**, which are created by a manufacturer or distributor, but are monitored by an independent, external organisation which, in general, is accredited.

The best-known European environmental labels are:

- The European Ecolabel - <http://www.eco-label.com>
- The Natureplus label - <http://www.natureplus.org>
- The Ange Bleu (Blauer Engel) label - <http://www.blauer-engel.de>
- The NF Environnement label – <http://www.marque-nf.com>
- The NordicSwan label – <http://www.svanen.nu/eng>
- The Milieukeur label - <http://www.milieukeur.nl>

Moreover, since the 1990s, labelling systems for construction materials, incorporating requirements in terms of indoor air quality have been developed in certain European countries:

- M1 classification (Finland - <http://www.rakennustieto.fi/index/english/emissionclassificationofbuildingmaterials.html>);
- Indoor Air Climate Label ICL (Denmark - <http://www.teknologisk.dk/ydelser/253>);
- GUT/EMICODE/Blauer Engel/AgBB label (Germany);
- The AFSSET protocol (France).



Illustration : Écolabel européen, label Natureplus, label Blauer Engel, label Nordic Swan, label NF Environnement, label Milieukeur

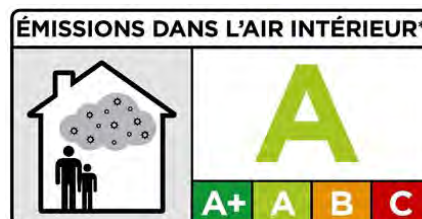

→ Checklist-type tools

Checklist-type evaluation methods are the most widespread evaluation tools and prove to be relatively simple to use. They are designed to be used by project owners, developers, architects and some building technical services.

They come in the form of lists of criteria with tick boxes. Each criterion has a graduated scoring system linked to a weighting factor; the final result is calculated by adding up the weighted scores for each criterion.

Thus, the checklist implies that the user has an in-depth knowledge of the building and its components.

The checklist does not give a numerical result, but an assessment in the form of a percentage, letters (A, B, C, D) or numbers (one, two, three, four etc.).

The various checklists are:

- NIBE Standard (The Netherlands)

SUSTAINABLE REFURBISHMENT OF SCHOOL BUILDINGS

3. REDUCE NON ENERGY RESOURCES CONSUMPTION



- Green Guide to Housing Specifications (BRE, Britain)
- ECOBAU, ECO-DEVIS sheets (www.ecobau.ch, Switzerland)
- The publication «Leitfaden für nachhaltiges - bauen und renovieren» (www.crte.lu, Luxembourg)
- Baubook - PassivHaus Bauteilkatalog – Ökologisch bewertete konstruktionen' (www.baubook.info, Austria)



→ LCA software

Environmental assessment software based on life-cycle analysis is generally more complex than checklists with regard to calculation methods.

These methods aim to provide an overall evaluation of environmental and health impacts using criteria such as global warming, resource depletion etc. This evaluation is generally made for a complete life-cycle – cradle to grave.

The LCA software is:

- Ecobalance KBOB (www.bbl.admin.ch/kbob , Switzerland)
- Catalogue construction (www.bauteilkatalog.ch , Switzerland)
- ECO-BAT (www.ecobat.ch, Switzerland)
- Ecosoft (www.ibo.at, Austria)
- ENVEST2 (BRE - www.invest2.bre.co.uk)
- EQUER (http://www.izuba.fr/logiciel/euer)
- ECOQUANTUM (MRPI – to be filled in)
- LEGEP (to be filled in)
- ELODIE ((http://www.elodie-cstb.fr)

SUSTAINABLE REFURBISHMENT OF SCHOOL BUILDINGS

3. REDUCE NON ENERGY RESOURCES CONSUMPTION



3.4. Reduce non energy resources consumption - Breeam assessment method

To assess the issue «Reduce non energy resources consumption», BREEAM assessment method proposes various criteria mainly listed under three environmental sections

- section « **WATER** » with a weighting of 6 % in the evaluation
 - WAT 01: Water Consumption
 - WAT 02: Water monitoring
 - WAT 03: Water leak detection and prevention
- section « **MATERIALS** » with a weighting of 12.5 % in the evaluation
 - MAT 01: Life cycle impacts
 - MAT 02: Hard landscaping and boundary protection
 - MAT 03: Responsible sourcing of materials
 - MAT 04: Insulation
 - MAT 05: Designing for robustness
- section « **POLLUTION** » with a weighting of 10 % in the evaluation
 - POL 03: Surface water run off

Therefore, an overview of these criteria is presented below.

For additional information : <http://www.breeam.org/page.jsp?id=381>

3.4.1. WAT 01 - Water Consumption

This issue aims to reduce the consumption of potable water for sanitary use in buildings from all sources through the use of water efficient components and water recycling systems.. This issue is **not mandatory** to achieve a minimum standard but provides a maximum of 5 credits.

Criteria	Number of credits	Explanation
Water Consumption	1 to 5 credits	<p>An assessment of the efficiency of the building's domestic water consuming components is undertaken using the BREEAM Wat 01 calculator.</p> <p>The water consumption (litres/person/day) for the assessed building is compared against a baseline performance and BREEAM credits awarded as follows:</p> <ul style="list-style-type: none"> - 1 credit: 12.5% of improvement - 2 credits: 25% of improvement - 3 credits: 40% of improvement - 4 credits: 50% of improvement - 5 credits : 55% of improvement - exemplary performance : up to 65% of improvement <p>The efficiency of the following 'domestic scale' water consuming components must be included in the calculation (where specified): WCs, Urinals, Taps (wash hand basins and where specified kitchen taps and waste disposal unit), Showers, Dishwashers (domestic and commercial sized)</p> <p><i>Comment:</i></p> <p><i>Where a greywater and/or rainwater system is specified, its yield (l/person/day) can be used to off-set non potable water demand from components that would otherwise be supplied using potable water.</i></p>

3.4.2. WAT 02 - Water Monitoring

This issue aims to ensure water consumption can be monitored and managed and therefore encourage reductions in water consumption. This issue is **mandatory** to achieve a minimum standard.

3. REDUCE NON ENERGY RESOURCES CONSUMPTION



Criteria	Number of credits	Explanation
Water Monitoring	1 credit	<p>The specification of a water meter on the mains water supply to each building; this includes instances where water is supplied via a borehole or other private source.</p> <p>Water-consuming plant or building areas, consuming 10% or more of the building's total water demand, are either fitted with sub meters or have water monitoring equipment integral to the plant or area</p> <p>Each meter (main and sub) has a pulsed output to enable connection to a Building Management System (BMS) for the monitoring of water consumption.</p> <p>If the site on which the building is located has an existing BMS, managed by the same occupier/owner (as the new building), the pulsed water meter(s) for the new building must be connected to the existing BMS</p>

3.4.3. WAT 03 - Water leak detection and prevention

This issue aims to reduce the impact of water leaks that may otherwise go undetected. This issue is **not mandatory** to achieve a minimum standard and provides two credits.

Criteria	Number of credits	Explanation
Water leak detection and prevention	1 to 2 credits	<p>For one credit:</p> <p>A leak detection system which is capable of detecting a major water leak on the mains water supply within the building and between the building and the utilities water meter.</p> <p>The leak detection system is:</p> <ul style="list-style-type: none"> - Audible when activated - Activated when the flow of water passing through the water meter/data logger is at a flow rate above a pre-set maximum for a pre-set period of time - Able to identify different flow and therefore leakage rates, e.g. continuous, high and/or low level, over set time periods - Programmable to suit the owner/occupiers' water consumption criteria - Where applicable, designed to avoid false alarms caused by normal operation of large water-consuming plant such as chillers. <p>For one more credit:</p> <p>One of the following types of flow control device is fitted to each WC area/facility to ensure water is supplied only when needed (and therefore prevent minor water leaks):</p> <ul style="list-style-type: none"> - A time controller i.e. an automatic time switch device to switch off the water supply after a predetermined interval - A programmed time controller i.e. an automatic time switch device to switch water on and/or off at predetermined times. - A volume controller i.e. an automatic control device to turn off the water supply once the maximum preset volume is reached. - A presence detector and controller i.e. an automatic device detecting occupancy or movement in an area to switch water on and turn it off when the presence is removed. - A central control unit i.e. a dedicated computer-based control unit for an overall man-aged water control system, utilising some or all of the types of control elements listed above.

SUSTAINABLE REFURBISHMENT OF SCHOOL BUILDINGS

3. REDUCE NON ENERGY RESOURCES CONSUMPTION



3.4.4. MAT 01 - Life cycle impact

This issue aims to recognise and encourage the use of construction materials with a low environmental impact (including embodied carbon) over the full life cycle of the building. This issue is **not mandatory** to achieve a minimum standard.

Criteria	Number of credits	Explanation
Life cycle impacts	1 to 6 credits	<p>BREEAM credits on the basis of the building's quantified environmental life cycle impact through assessment of the main building elements.</p> <p>For school buildings, main building elements are: external walls, windows, roofs, upper floor slab, internal walls, floor coverings.</p> <p>Credits are awarded on the basis of the total number of points achieved. This point's score is based on the Green Guide rating(s) achieved for the specifications that make-up the main building elements:</p> <ul style="list-style-type: none"> - 1 credit : total points achieved \geq 4 - 2 credits: total points achieved \geq 5 - 3 credits: total points achieved \geq 8 - 4 credits: total points achieved \geq 10 - 5 credits: total points achieved \geq 12 - 6 credits: total points achieved \geq 14 <p>Lifecycle Green House Gas emissions (kgCO₂eq.) for each element are also required to be reported based on a 60-year building life. Where specific data is not available for a product or element, generic data should be used. Generic data can be obtained from the online Green Guide for each element.</p>

3.4.5. MAT 02 - Hard landscaping and boundary protection

This issue aims to recognise and encourage the specification of materials for boundary protection and external hard surfaces that have a low environmental impact, taking account of the full life cycle of materials used. This issue is **not mandatory** to achieve a minimum standard.

Criteria	Number of credits	Explanation
Hard landscaping and boundary protection	1 credit	Where at least 80% of all external hard landscaping and boundary protection (by area) achieves an A or A+ rating, as defined in the Green Guide to Specification. Green Guide ratings for the specification(s) of each element can be found at: www.thegreenguide.org.uk

3.4.6. MAT 03 - Responsible sourcing of materials

This issue aims to recognise and encourage the specification of responsibly sourced materials for key building elements. This issue is **mandatory** to achieve a minimum standard (criteria 3 only).

Criteria	Number of credits	Explanation
Responsible sourcing of materials	1 to 3 credits	<ol style="list-style-type: none"> 1. Each of the applicable specified materials comprising the main building elements are assigned a responsible sourcing tier level and points awarded. The tier rank is determined based on the rigour of responsible sourcing demonstrated by the supplier(s)/ manufacturer(s) of that material/element (through responsible sourcing certification schemes). 2. The number of BREEAM credits achieved is determined as follows: <ul style="list-style-type: none"> - 3 credits : \geq 54 % of available points achieved - 2 credits: \geq 36 % of available points achieved - 1 credit : \geq 18 % of available points achieved 3. Confirmation that all timber used on the project is sourced in accordance with the UK Government's Timber Procurement Policy

SUSTAINABLE REFURBISHMENT OF SCHOOL BUILDINGS

3. REDUCE NON ENERGY RESOURCES CONSUMPTION



3.4.7. MAT 04 - Insulation

This issue aims to recognise and encourage the use of thermal insulation which has a low embodied environmental impact relative to its thermal properties and has been responsibly sourced. This issue is not **mandatory** to achieve a minimum standard and This issue is split into three parts:

Criteria	Number of credits	Explanation
Pre-requisite		Any new insulation specified for use within the following building elements must be assessed: External walls, Ground floor, Roof and Building services
Embodied impact	1 credit	<p>The Green Guide rating for the thermal insulation materials must be determined. Green Guide ratings for thermal insulation can be found at: www.thegreenguide.org.uk</p> <p>The Insulation Index for the building insulation is the same as or greater than 2. 4.</p> <p>The Insulation Index is calculated using the BREEAM Mat 04 calculator which uses the following calculation methodology:</p> <p>For each type of thermal insulation used in the relevant building elements, the volume weighted thermal resistance provided by each type of insulation is calculated as follows:</p> <p>a. $(\text{Area of insulation (m}^2) \times \text{thickness(m)}) / \text{Thermal Conductivity (W/ m.K)}$</p> <p>OR</p> <p>b. $\text{Total volume of insulation used (m}^3) / \text{Thermal conductivity (W/m.K)}$</p> <p>The volume weighted thermal resistance for each insulation material is then multiplied by the relevant Green Guide point(s) from the following table to give the Green Guide Rating corrected value.</p>
Responsible sourcing	1 credit	At least 80% by volume of the thermal insulation used in the building elements identified in Item 1 must be responsibly sourced i.e. each insulation product must be certified in accordance with either tier levels 1, 2, 3, 4, 5 or 6 as described in BREEAM issue Mat 03.

3.4.8. MAT 05 - Designing for robustness

This issue aims to recognise and encourage adequate protection of exposed elements of the building and landscape, therefore minimising the frequency of replacement and maximising materials optimisation. This issue is not **mandatory** to achieve a minimum standard.

Criteria	Number of credits	Explanation
Designing for robustness	1 credit	<p>Areas of the building have been identified (both internal and external) where vehicular, trolley and pedestrian movement occur.</p> <p>The design incorporates suitable durability and protection measures or design features/ solutions to prevent damage to the vulnerable parts of the building.</p> <p>This must include, but is not necessarily limited to:</p> <ul style="list-style-type: none"> - Protection from the effects of high pedestrian traffic in main entrances, public areas and thoroughfares (corridors, lifts, stairs, doors etc). - Protection against any internal vehicular/trolley movement within 1m of the internal building fabric in storage, delivery, corridor and kitchen areas. - Protection against, or prevention from, any potential vehicular collision where vehicular parking and manoeuvring occurs within 1m of the external building façade for all car parking areas and within 2m for all delivery areas.

3.4.9. POL 03 - Surface water run off

This issue aims to avoid, reduce and delay the discharge of rainfall to public sewers and watercourses, therefore minimising the risk of localised flooding on and off site, watercourse pollution and other environmental damage. This issue is not **mandatory** to achieve a minimum standard but could provide a maximum of 5 credits. This issue is split into three parts:

SUSTAINABLE REFURBISHMENT OF SCHOOL BUILDINGS

3. REDUCE NON ENERGY RESOURCES CONSUMPTION



Criteria	Number of credits	Explanation
Flood risk	1 or 2 credits	<p>For 2 credits:</p> <ol style="list-style-type: none"> Where the assessed development is situated in a flood zone that is defined by the relevant planning, policy and technical guidance documents, as having a low annual probability of flooding. A site specific Flood Risk Assessment (FRA) confirms that there is a low risk of flooding from all sources. <p>For 1 credit:</p> <ol style="list-style-type: none"> Where the assessed development is situated in a flood zone that is defined by the relevant planning, policy and technical guidance documents, as having a medium or high annual probability of flooding and is not within the Functional Floodplain AND A site specific Flood Risk Assessment (FRA) confirms to the satisfaction of the local authority and statutory body that the development is appropriately flood resilient and resistant from all sources of flooding AND The ground level of the building and access to both the building and the site, are designed (or zoned) so they are at least 600mm above the design flood level of the flood zone in which the assessed development is located.
Surface water run off		<p>Pre-requisite</p> <ol style="list-style-type: none"> An appropriate consultant is appointed to carry out, demonstrate and/or confirm the following criteria: <p>For 1 credit:</p> <ol style="list-style-type: none"> Where drainage measures are specified to ensure that the peak rate of run-off from the site to the watercourses (natural or municipal) is no greater for the developed site than it was for the pre-development site. This should comply at the 1 year and 100 year return period events. Calculations include an allowance for climate change; this should be made in accordance with current best practice planning guidance. <p>For 1 more credit</p> <ol style="list-style-type: none"> Where flooding of property will not occur in the event of local drainage system failure (caused either by extreme rainfall or a lack of maintenance) <p>AND EITHER</p> <ol style="list-style-type: none"> The post development run-off volume, over the development lifetime, is no greater than it would have been prior to the assessed site's development. Any additional predicted volume of run-off for the 100 year 6 hour event must be prevented from leaving the site by using infiltration or other techniques
Minimising water course pollution		<p>For 1 credit:</p> <p>The Appropriate Consultant confirms that there is no discharge from the developed site for rain-fall up to 5mm.</p> <p>Specification of Sustainable Drainage Systems (SUDs) or source control systems such as permeable surfaces or infiltration trenches where run-off drains are in areas with a relatively low risk source of watercourse pollution.</p> <p>Specification of oil/petrol separators (or equivalent system) in surface water drainage systems, where there is a high risk of contamination or spillage of substances such as petrol and oil.</p> <p>All water pollution prevention systems have been designed and detailed in accordance with the recommendations of Pollution Prevention Guideline 31.</p>

SUSTAINABLE REFURBISHMENT OF SCHOOL BUILDINGS

4. REDUCE WASTE PRODUCTION

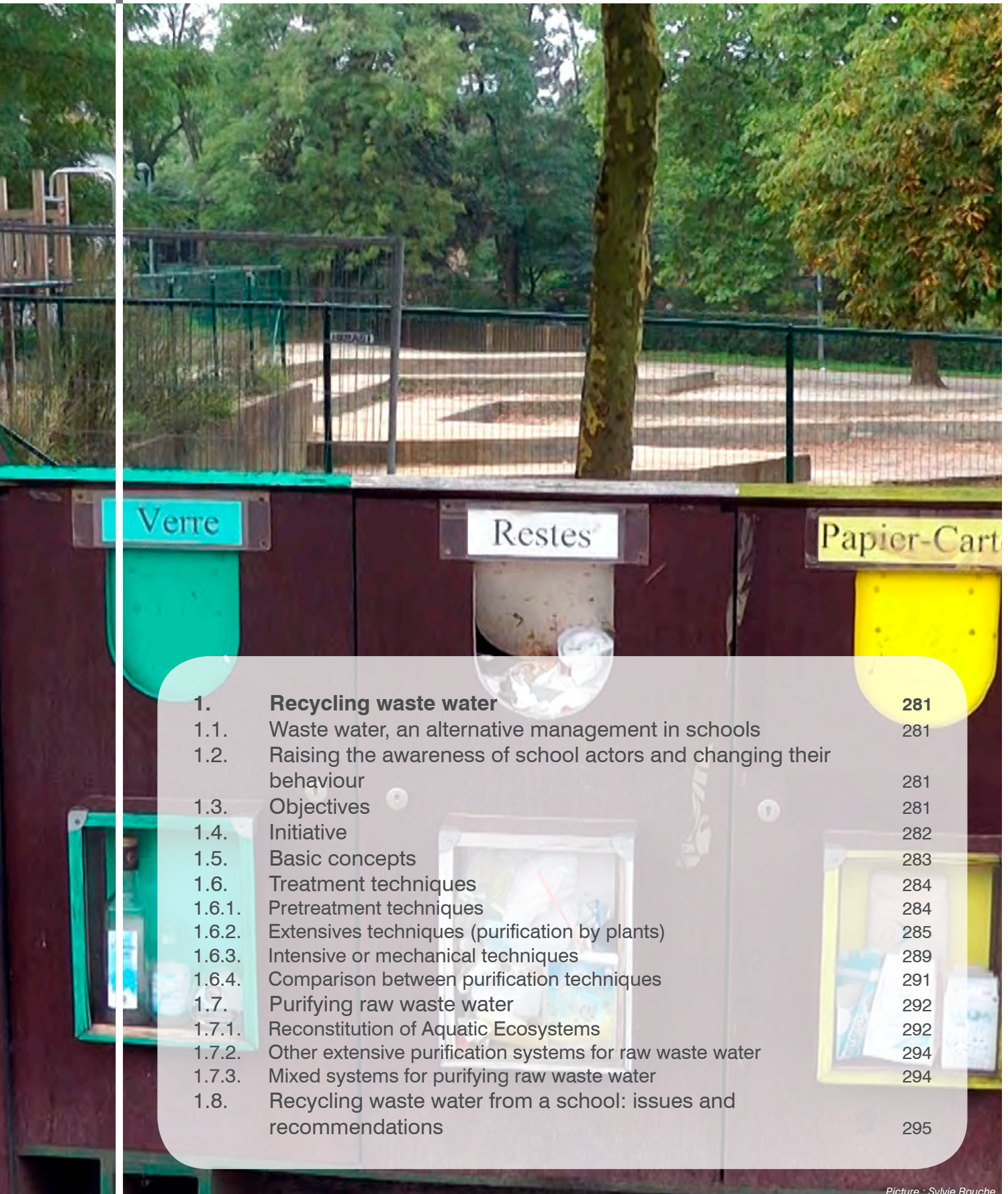

1.	Recycling waste water	281
1.1.	Waste water, an alternative management in schools	281
1.2.	Raising the awareness of school actors and changing their behaviour	281
1.3.	Objectives	281
1.4.	Initiative	282
1.5.	Basic concepts	283
1.6.	Treatment techniques	284
1.6.1.	Pretreatment techniques	284
1.6.2.	Extensives techniques (purification by plants)	285
1.6.3.	Intensive or mechanical techniques	289
1.6.4.	Comparison between purification techniques	291
1.7.	Purifying raw waste water	292
1.7.1.	Reconstitution of Aquatic Ecosystems	292
1.7.2.	Other extensive purification systems for raw waste water	294
1.7.3.	Mixed systems for purifying raw waste water	294
1.8.	Recycling waste water from a school: issues and recommendations	295

Picture : Sylvie Rouche

2.	Reducing, managing and using construction and demolition waste	297
2.1.	Quantity and distribution of construction waste by country	297
2.2.	Preventive measures: reduction at source	298
2.2.1.	Preventive measures during the design phase – building’s adaptability	298
2.2.2.	Preventive measures to be applied to the construction process	298
2.2.3.	Preventive measures in the choice of construction materials	299
2.2.4.	Preventive measures when using new materials and construction elements	299
2.3.	Manage waste and give it added value at the site	300
2.3.1.	Waste value added outlets	300
2.3.2.	Downcycling and upcycling, an important shade of meaning	301
2.3.3.	Objectives of on-site waste management	302
2.3.4.	Pre-study for waste management	302
2.3.5.	Management of waste at the site	304
2.3.6.	A few possible destinations for construction and demolition waste	306
2.3.7.	Riva Bella school refurbishment - concept of reuse	308
3.	Reducing, managing and added value from functional waste	309
3.1.	Waste production in schools	309
3.2.	Reducing waste at source – behaviour to adopt	309
3.2.1.	Waste reduction policy	309
3.2.2.	A “waste” inventory in each school	309
3.3.	Managing and making good use of functional waste	310
3.3.1.	Principles for managing domestic or similar waste	310
3.3.2.	Containers or skips	310
4.	Reduce waste production - Breeam assessment method	312
4.1.	WST 01 - Construction waste management	312
4.2.	WST 02 - Recycled aggregates	313
4.3.	WST 03 - Operational waste	313

SUSTAINABLE REFURBISHMENT OF SCHOOL BUILDINGS

4. REDUCE WASTE PRODUCTION



4.1. Recycling waste water



4.1.1. Waste water and alternative management in schools

Canteens, washrooms, air-conditioning etc. Direct or indirect consumption in educational institutions or businesses is far from negligible. A pupil at school can use between 10 and 100 litres of water daily, depending on their activities. In offices, consumption varies considerably depending on the devices used. It is estimated at between 10 and 30 litres a day in buildings that are not well-equipped; average consumption per employee can amount to as much as 225 litres, if they work in an air-conditioned office and if there is a staff canteen. Source: <http://www.lyonnaise-des-eaux.fr/particuliers/votre-quotidien/chiffres-consommation-collective-deau>

Waste water management is one of the major challenges in water management at educational establishment level, in view of the substantial amounts of water discharged. It is an opportunity to set up an alternative and appropriate treatment for “domestic” waste water inspired mainly by the operation of natural aquatic ecosystems.

This initiative should be encouraged due to the fact that it has been found that there is poor performance (or absence thereof) in waste water purification by collective treatment plants, meaning that treatment of the various types of pollution is incomplete.

These treatments which are alternatives to “everything down the drain” also have the advantage of bringing greenery to school playgrounds and open spaces, thus improving their quality without causing public health risks or affecting child safety because, depending on the type of system surface, water will be absent or only present in very small quantities.

These treatments will raise consciousness among the children and their teachers as to the natural cycle of water and the challenges it involves in terms of consumption, pollution etc.

4.1.2. Raising the awareness of those involved and changing their behaviour

When schools are being renovated, the strategies for water management and recycling that should be developed ought to include an educational aspect: creating a different water culture by incorporating the project into the water cycle and offering a landscaping opportunity for the development of biodiversity.

4.1.3. Objectives

To recycle waste water or use it in construction with the aim of incorporating the renovation project into the natural water cycle, only discharging water into the environment that complies with the recipient surroundings:

- In terms of quality - OBJECTIVE: aiming at “zero discharge of pollutants from the plot of land”
 - avoid polluting clean water;
 - separating out the pollutants as far up the chain as possible (separation of different types of water: rainwater, greywater, blackwater, etc.);
 - guaranteeing the quality of waste water after treatment;
 - avoiding the discharge of diluted waste water into the main drainage
- In quantity - OBJECTIVE: aim for “zero rainwater discharge from the plot of land”
 - returning the water to its natural environment as far up the chain as possible;
 - creating water cycle loops within the renovation projects to extend their course and only discharging very little of the water.

SUSTAINABLE REFURBISHMENT OF SCHOOL BUILDINGS

4. REDUCE WASTE PRODUCTION



Various techniques exist for treating waste water. The techniques known as (extensive) “landscaping” should be prioritised since they promote biodiversity through the choice of native plants as well as enabling enhancement of the environment and various applications on every scale of project (individual homes, collective housing, schools, offices, district, etc.) as well as raising awareness and involving the occupants or inhabitants.

4.1.4. Initiative

The initiative proposed in this chapter consists in developing alternative waste water management while complying with the following principles:

- **Discharging as little water as possible from the plot of land dedicated to the renovation project.**

Reducing water consumption as far as possible in the buildings for renovations, particularly in the washrooms and kitchen by making the right choice of fittings.

- **Choosing the water quality most appropriate for use**

Using drinking water solely for uses for which it is indispensable (food and hygiene) and considering resorting to alternative sources of water for all other uses: WC tanks, urinals, watering green spaces, maintaining the building surrounds, building maintenance and cleaning.

- **If possible, plan to install separate drainage networks if the water pipes need renewing.**

Separating rain water and waste water in the water drainage system makes it possible to avoid dilution of waste water pollution directed to a purification collective treatment plant or a treatment plant “in situ” . This separation of water flows makes it possible to treat each type of pollution differently and appropriately. It also facilitates purification and/or re-use depending on usage.

- **Consider alternative waste water management on the plot of land.**

Alternative management can also be prioritised as desired as follows:

- “In situ” (blackwater and greywater) waste water treatment, preferably extensively, with recovery via the consumption cycle for the building.
- “In situ” (blackwater and greywater) waste water treatment, preferably extensively (inserted filters) with discharge into a surface water system;
- “In situ” greywater purification, preferably extensively with discharge into a surface water system or recovery via the consumption cycle for the building.

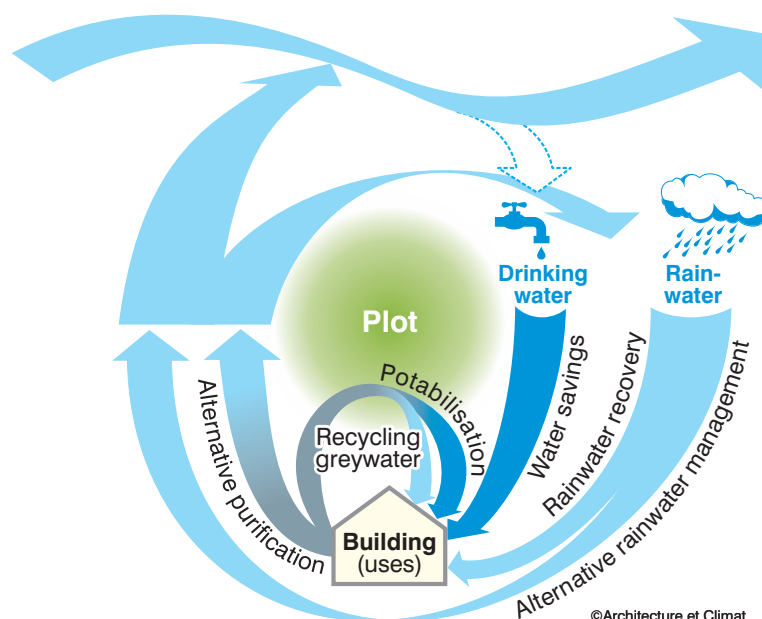

SUSTAINABLE REFURBISHMENT OF SCHOOL BUILDINGS

4. REDUCE WASTE PRODUCTION



4.1.5. Basic concepts

→ Types of waste water

There are three major categories of waste water: domestic waste water, water used by industry, and rainwater and run-off. Waste water from schools can be compared to domestic waste water, even though it sometimes contains paint, detergent and other solvents

This waste water consists of:

- **Blackwater or sewage**

Blackwater or sewage water consists of water discharged from washing and toilet facilities and urinals. They are heavily charged and contain a considerable amount of physical, organic, tertiary and bacteriological pollution. Blackwater can also be separated into urine and faeces which can contain very specific pollutants.

- **Greywater (kitchen, washrooms)**

Greywater consists of washing water (showers, wash-ponds, sinks, dishwashers, cooking, etc.) and represents about 70% of the volume of water consumed. It combines physical and light organic pollution, more marked tertiary pollution (soaps and detergents) and bacteriological pollution.

- **So-called clear water**

So-called clear water consists of rainwater and run-off, that contains little pollution. Under no circumstances should this water be mixed with black and grey waters.

→ Types of pollution

The various types of pollution that can be encountered in waste water are as follows:

- **Primary (or physical) pollution**

Pollution by particles in suspension that can turn into sediment in water courses or aquatic ecosystems. This type of pollution constitutes a barrier to photosynthesis, rendering plant life at depth impossible, reducing the quantity of oxygen dissolved in the water, disrupting the biological activity of the aquatic ecosystem through lack of oxygen and light.

- MIS: matter in suspension (mg/l)
- SM: sedimentable matter (mg/l)

- **Secondary (or organic) pollution**

Pollution by dissolved organic matter. This dissolved matter should be considered as “nutrients” promoting the growth of anaerobic bacteria (methane production). This type of pollution causes a reduction in the quantity of dissolved oxygen and disrupts the aquatic ecosystem through lack of oxygen (asphyxiation of the environment).

- DBO5: biological requirement for O₂ (mg/l in five days)
- DCO: chemical requirement for oxygen (mg/l)

- **Tertiary (or mineral) pollution**

Pollution by nitrates and phosphates contained in faecal matter, kitchen waste, detergents, fertilisers, etc. The pollutants consist of NH₄⁺ ammonium, NO₂-nitrites, NO₃- nitrates, the PO₄ phosphates, etc.

This matter creates an imbalance in the natural carbon, nitrogen and phosphorus cycles and causes the phenomenon of eutrophication of the surface water through a proliferation of algae.

- N: Nitrogen (mg/l)
- P: Phosphorus (mg/l)

- **Quaternary (or microbial) pollution**

Pollution by pathogens, either bacteria or viruses, mainly of faecal origin such as:

- Salmonella: typhus and typhoid fever
- Shigella: dysentery
- Enterovirus: poliomyelitis, hepatitis A

- **Chemical Pollution**

Pollution – mainly of run-off water – from heavy metals, hydrocarbons, solvents, fabric softeners or other complex chemicals. This type of pollution is largely found in industrial waste rather than in domestic waste water but can originate from parking lots, roadways or certain types of roofing (zinc, copper, etc.).

SUSTAINABLE REFURBISHMENT OF SCHOOL BUILDINGS

4. REDUCE WASTE PRODUCTION



Day-to-day pollution produced by an individual using 150 to 200 litres of water is estimated at :

- 90 grams of organic matter or minerals
- 57 grams of oxidising matter
- 15 grams of nitrogenous matter
- 4 grams total of phosphorus
- 0.23 grams of heavy metal residue (lead, cadmium, arsenic, mercury, etc.)
- 0.05 grams of composite chemicals (fluoride, chloride, bromide, iodine etc.)
- 1 to 10 billion germs per 100 ml.

In terms of waste water treatment, a shared synthetic unit of measurement is used (relating to the various types of pollution), namely the EQUIVALENT-INHABITANT (E.I.), corresponding to 60g DBO5 per day

4.1.6. Treatment techniques

4.1.6.1. Pre-treatment techniques

The following text comes from two principal sources: "Guide pratique pour la construction et rénovation durable de petits bâtiments" [Technical Guide to the Sustainable Construction and Renovation of Small Buildings], IBGE, Brussels, 2006 and "Waterwegwijzer voor architecten" [Water Treatment for Architects] Vlaams Milieu Maatschappij, 2002/2010.

→ Screening

A discharge chamber fitted with one or more small-mesh grilles to hold back objects of smaller or larger size.

Screening is designed to prevent the flow into the sewers and connecting pipes of bulky items that could block or disrupt the treatment downstream in the waste water system.

→ Sedimentation tank or decanter

This tank operates on the decantation principle: the particles in suspension that are heavier than water are caused by their weight to fall to the bottom of the tank.

If it is to work well, the water must be as still as possible. The surface water decanted continues its treatment in a second tank. The sludge at the bottom of the tank is regularly evacuated: the sludge is flushed out and removed regularly in a tanker. This operation is necessary to prevent any risk of clogging the waste water pipes.

→ Grease separator

This system is installed on the discharge pipes for kitchen waste, as close as possible to the source. The particles of grease and oil, which are lighter than water, are separated from the water by rising to the surface.

This system requires regular maintenance.

→ Septic tank

The purpose of this pre-treatment is to initiate the purification processes and reduce the organic load and matter in suspension:

- the physical action of decantation and floating of matter in suspension;

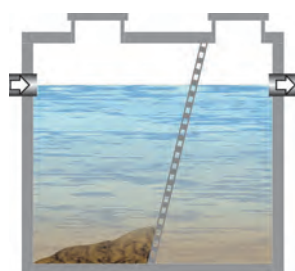

Screening

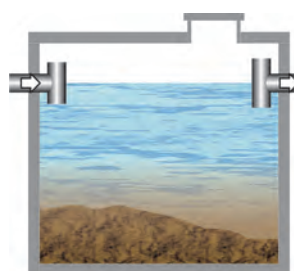

Sedimentation tank

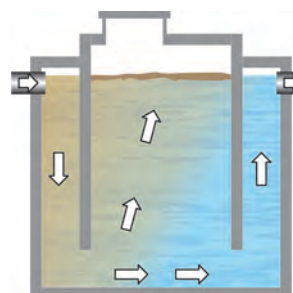

Grease separator

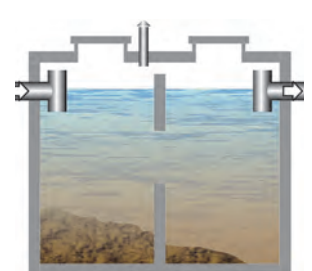

Septic tank

SUSTAINABLE REFURBISHMENT OF SCHOOL BUILDINGS

4. REDUCE WASTE PRODUCTION



- biological action consisting in the digestion of the load of pollutants by microorganisms.

A septic tank must be emptied regularly, about every two years. Under no circumstances should it be emptied completely. A seed volume of sludge of about 20% must be retained. A septic tank must not be allowed to receive rainwater or run-off from roofs or other surfaces on which it collects. The traditional septic tank is only loaded with faecal water but it can also be used to pre-treat greywater from the kitchen (that has first been treated in a degreaser) and from washrooms:

- Septic tank yield (blackwater and greywater): 30% of the organic load
- Septic tank yield (pre-treated greywater): 60 to 80% of the organic load

The tanks may be made of concrete or a synthetic material. Special attention should be paid to the resistance of the walls which could deteriorate through the corrosive action of the fermentation gases.

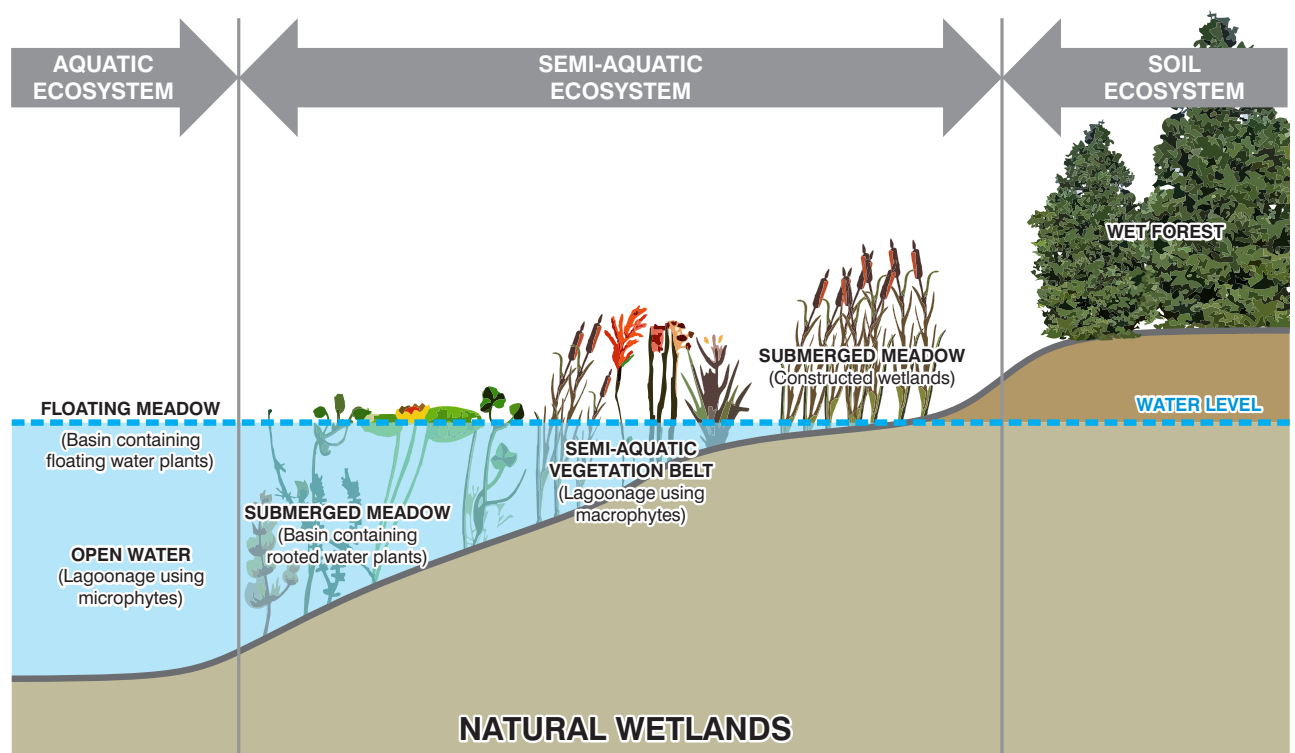

Natural aquatic ecosystem

4.1.6.2. Extensive techniques

The basic principles of the extensive techniques are interesting to the extent that they inspire biological activity in natural aquatic ecosystems. Aquatic ecosystems actually have a natural purification ability based on their conversion and assimilation of so-called “domestic” pollutants through the aquatic food chains .

Extensive techniques reproducing a diagram of the natural cycles of certain elements such as nitrogen and carbon in a waterproofed, planted pond or ponds. The interest in extensive techniques lies in their great flexibility in dealing with variations in organic loads (concentrations) or hydraulic loads.

Waste water for treatment using the extensive technique must first be pre-treated (septic tank). The various techniques are as follows:

→ Lagoona and derivative techniques – 10m²/E.H

Lagoons are areas of an aquatic environment in which the flow moves slowly and in which bacteria and other living organisms proliferate and consume organic matter. It is known as stagnant water and a “free water” ecosystem. This type of lagoon can present in different variations: lagoons containing submerged vegetation, lagoons with emerging vegetation (floating meadows) or rooted vegetation, lagoon with rooted plants, etc.

Lagoons generally take up more land space than reconstituted wetlands.

A lagoon purification system should consist as a minimum of:

- a microphyte lagoon containing algae and des microorganisms;

SUSTAINABLE REFURBISHMENT OF SCHOOL BUILDINGS

4. REDUCE WASTE PRODUCTION



- a macrophyte lagoon containing a variety of plants

It is the complementarity between microorganisms, algae and plants that makes this technique efficient. On the one hand, microorganisms break down organic matter and mineralise it. The sludge resulting from the breakdown of organic matter accumulates at the bottom of the ponds. On the other hand, the algae and plants benefit from an environment rich in nitrogen derivatives and phosphorus that helps them proliferate. Thanks to the sun's rays (which eliminate some of the biological contaminants), plant life can perform photosynthesis, thus absorbing CO₂ and emitting the oxygen that feeds the microorganisms.

A biological cycle is thus created. This is the basic principle of lagoonage that can take diverse forms depending on the context in which it is installed.

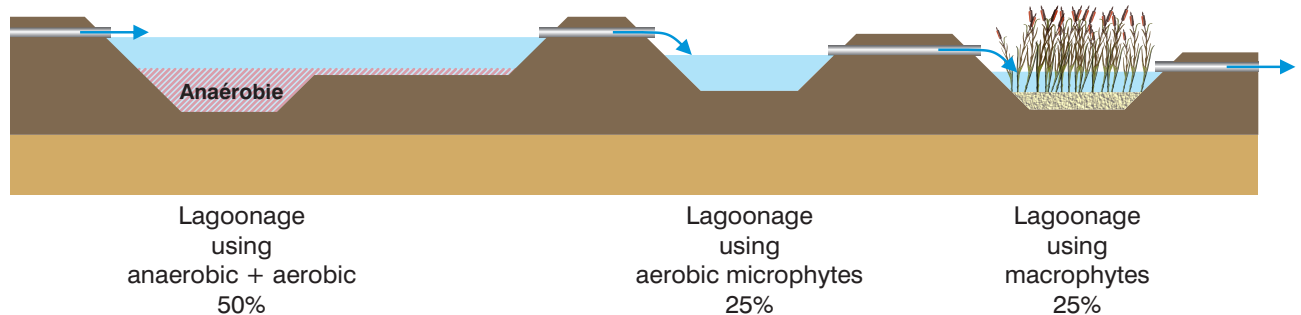

Microphytic Lagoon

A microphytic lagoon is a pond with a minimum depth of 75 cm –to prevent the growth of plants other than unicellular algae – receiving raw waste water loaded with organic matter, after the waste water has been “screened” and channelled into a degreasing tank.

It works based on the combined action of unicellular algae and bacteria. Thanks to light rays, the algae produce oxygen which enables the respiration and development of colonies of bacteria. Bacteria, as well as certain microscopic fungi, break down the organic matter into ammoniacal nitrogen.. In a well-oxygenated environment this is turned into nitrates that can be used as food by the algae.

Technical data:

- Area: 7.5m²/E.H
- Water depth: 60cm
- Substrate: clay soil for excavations
- Height of substrate: 15cm

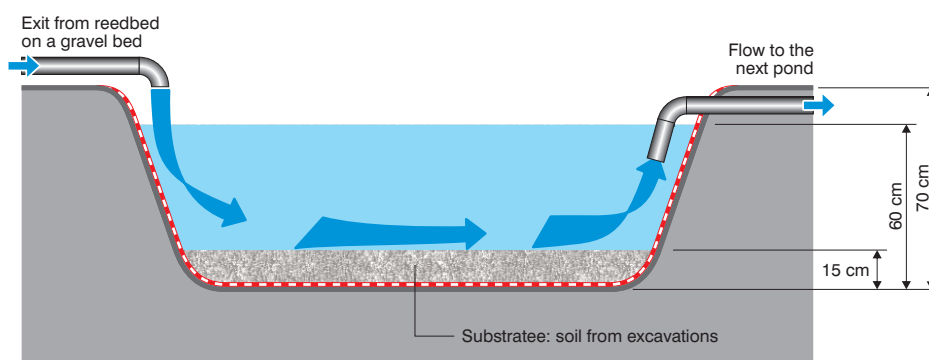

Macrophyte lagoon

The macrophyte lagoon is a pond planted with vegetation (bullrushes, phragmites, cattails, irises, reeds) with a water depth of 60cm.

The plants are attached to a substrate consisting of sand and gravel that is 40cm thick.

SUSTAINABLE REFURBISHMENT OF SCHOOL BUILDINGS

4. REDUCE WASTE PRODUCTION



The plants fix colonies of bacteria at the base of their stems and on their rhizomes. They also absorb some of the mineral salts – nitrates and phosphates – through their roots that are the results of the breakdown of organic matter in the waste water.

Most of the macrophytes are capable of absorbing the heavy metals that are always present in waste water.

Technical data:

- Area: 2.5 m²/E.H.
- Water depth: 60 cm
- Substrate (40cm): sand and gravel

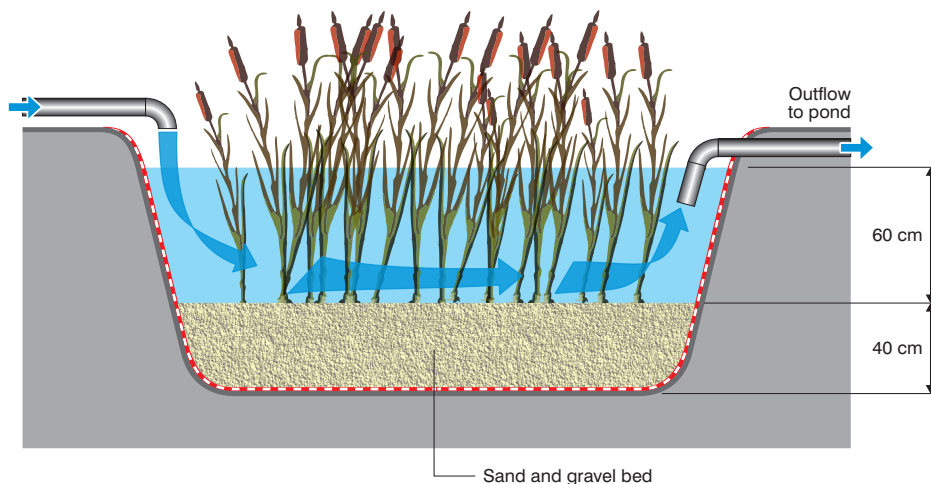

Source: www.eautarcie.com



→ Constituted wetlands or plant filters

Sand filter planted with reeds (Seidel Process – 3 to 7 m²/E.H.)

The reconstituted wetland is characterised by the vertical flow of water in the pond.

The area covered is very small but the land needs to have a gradient of at least 150 cm. Impermeability is created by laying masonry of breeze blocks or installing prefabricated concrete tanks.

The reeds stop the filter from becoming clogged, supply oxygen to the biomass and participate in the purification through the absorption of nitrogen and phosphorus.

Technical data:

- Area: 3 to 7 m²/E.H
- Water depth: /
- Substrate: soil, river sand, ballast of 20-40mm. Substrates are used in successive strata of different thicknesses
- Depth of substrate: 150cm
- Plants: reeds

Reedbed on gravel bed (Kickuth engineered wetlands – 5m²/E.H.)

This reconstituted wetland is typified by the horizontal flow of water in the pond.

Impermeability is created by laying an EPDM membrane on a bed of stabilised sand. The whole pond is filled with grit so that the water depth is a minimum of 5cm below the level of the substrate. The flow is horizontal. The reeds need to cover $\frac{3}{4}$ of the surface upstream of the lagoon, the remaining downstream $\frac{1}{4}$ should be planted with a different species.

Technical data:

- Surface: 5 m²/E.H.
- Water depth: 60cm
- Substrate: grit 7-14mm calibre
- Depth of substrate: 70cm
- Plants: reeds, marsh iris, rushes

SUSTAINABLE REFURBISHMENT OF SCHOOL BUILDINGS

4. REDUCE WASTE PRODUCTION

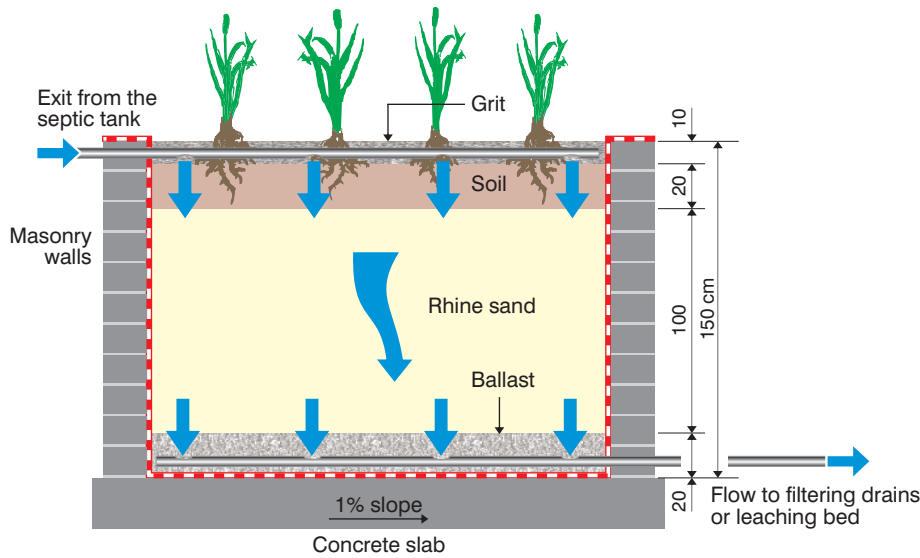

Sand filter planted with reeds, principle

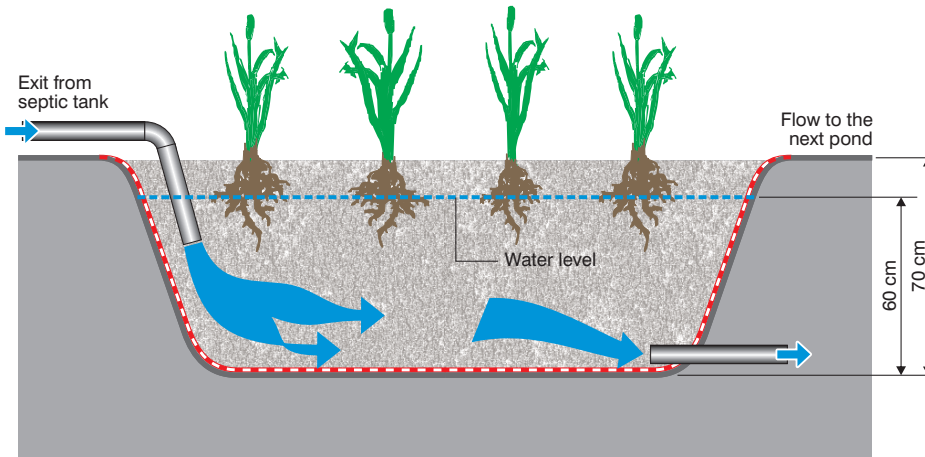

Reedbed on gravel bed, principle

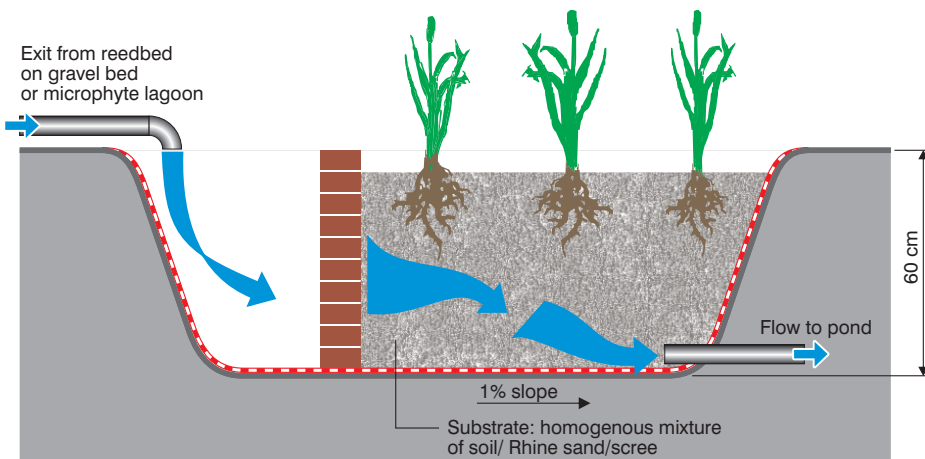

Reconstituted wetlands, principle

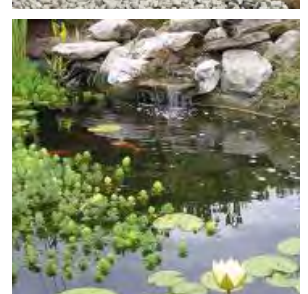

SUSTAINABLE REFURBISHMENT OF SCHOOL BUILDINGS

4. REDUCE WASTE PRODUCTION



Reconstituted wetlands (3 to 4 m²/E.H.)

Technical data

- Area: 5 to 8 m²/E.H.
- Substrate: soil, grit and Rhine sand
- Depth of substrate: 60cm

Need for a 1.5m³ buffer zone (without a substrate – 60cm water depth). The actual lagoon itself is filled with substrate - no water is visible. Evacuation is from below the surface of the lagoon.

→ Plants used for extensive purification

Plants varieties used for their purification abilities are aquatic, semi-aquatic and/or terrestrial varieties. They include:



1. Duckweed
2. White water-lilies
3. Bullrushes
4. Water clover
5. Phragmites
6. Reeds
7. Yellow flag
8. Lose strife
9. Sedge
10. Willow



4.1.6.2. Intensive techniques

Introductory remark

The so-called “intensive” techniques are not the most efficient techniques of all the types of purification.

In fact, their effectiveness is limited to the level of tertiary (nitrogen and phosphorus) and quaternary (bacteriological) pollution; these techniques consume more energy than the so-called “extensive” techniques because they require the use of pumps, aerators, etc. but they also need to be maintained by qualified manpower. For the reasons, these techniques will be mentioned only briefly.

→ Biological Discs

Biological Discs are an aerobic biological treatment using a fixed biomass.

Biological discs use the principle of the conversion and destruction of organic matter through microorganisms fixed onto a medium. The medium on which the microorganisms are fixed are discs that are partially submerged in the waste water to be treated and caused to rotate, thus ensuring the mixing (of waste water and microorganisms) and the oxygenation of the microorganisms. Cultures of microorganisms form a “biofilm” or purifying biological film on the surface of the discs.

The effluent previously decanted to avoid the material of the medium becoming clogged. The sludge that is then separated from the water which is treated through clarification.

The biological discs unit is created from discs attached to a tree in an open air pond filled with waste water. The discs rotate slowly in the pond and when they move into the waste water, the organic matter is absorbed by the biofilm attached to the discs. The accumulation of biological matter on the discs makes them thicker and forms a layer of sludge. When the discs move into the open air, the oxygen is absorbed, promoting the growth of the biomass. Once the biomass has absorbed the organic matter, the organic matter is broken down through aerobic par fermentation thanks to the oxygen.

SUSTAINABLE REFURBISHMENT OF SCHOOL BUILDINGS

4. REDUCE WASTE PRODUCTION

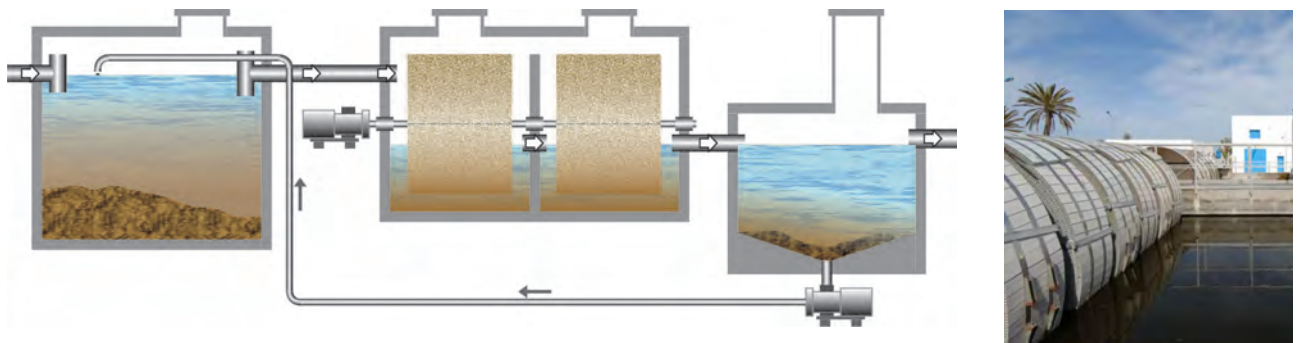

→ Activated sludge

Activated sludge is an aerobic biological treatment in free culture.

In this treatment process, the microorganisms develop in a pond which is partially fed with waste water to be treated and partially with oxygen through adding air. The microorganisms in suspension in the pond water, are thus in permanent contact with the pollutants, on which they feed and have the oxygen they need in order to digest them.

This means there has to be significant aeration (high energy consumption) to enable bacterial activity to be produced and the pollutants to be broken down.

This process is used for three specific purposes:

- Elimination of carbonised pollution (organic matter)
- Elimination of nitrogenous pollution

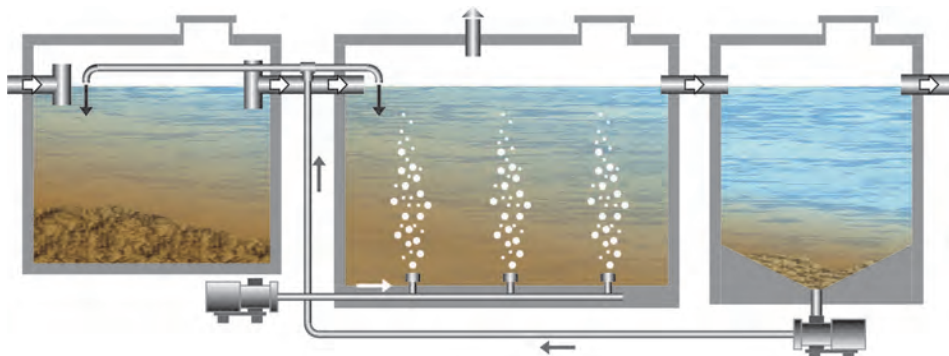

→ Bacterial (aerobic) bed

The aerobic bacterial bed is an aerobic biological treatment process using fixed cultures.

The microorganisms develop in a medium that placed above the level of the waste water to be treated and regularly irrigated by it. The medium consists of a filter of porous or cavernous material, such as pumice stone, gravel, synthetic materials, etc. on which the microorganisms form a biofilm or biological film that digests the pollution.

The filter is constantly aerated by natural aeration or forced ventilation. The water to be treated is dispersed over the upper part of the bed by means of a sprinkler. It then percolates through the filter. The pollutants are then absorbed by the biological film created by the aerobic bacteria on the surface and the anaerobic bacteria at depth. The biological film consists mainly of bacteria but also incorporates other organisms that are part of a more or less complex food chain (protozoa, insects, etc.). The by-products and carbon dioxide normally produced by the purification process are evacuated in the liquids or gases. The excess sludge (thickening of the biological film) which is naturally detached from the medium through the effect of the hydraulic load is separated from the waste water through secondary decantation (decanter-digester).

Note:

This system shows a considerable reduction in yield when the outside temperature drops to below 5°C

→ Submerged biomass (aerobic)

Submerged biomass is an aerobic biological treatment process using a fixed culture.

SUSTAINABLE REFURBISHMENT OF SCHOOL BUILDINGS

4. REDUCE WASTE PRODUCTION



The microorganisms are attached to a medium that is completely submerged in the waste water and/or floats in flakes. The aeration elements placed on the medium ensure the oxygenation of the microorganisms. The microorganisms are partially fed by the nutrients (nitrogen, phosphorus) contained in the waste water and use the carbon in the organic matter to synthesise their own material. From this they draw the necessary energy for their survival. Dead microorganisms coagulate and turn into sediment (in the form of sludge) at the bottom of the tank.

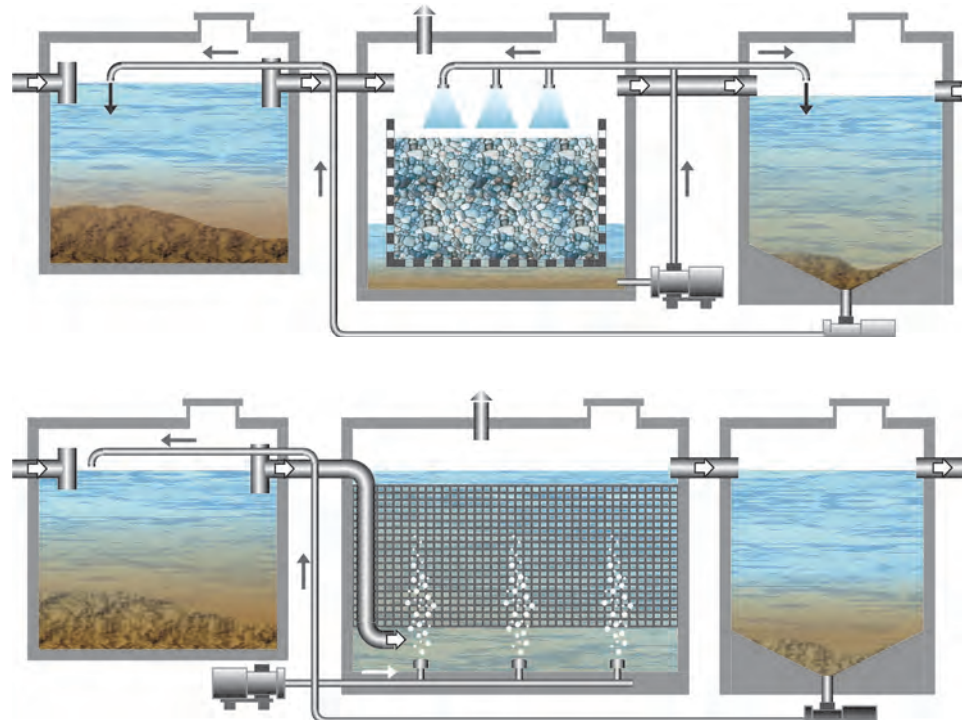

4.1.6.3. Comparison of purification techniques

		Centralised techniques	Extensive decentralized techniques	
		Biological discs Bacterials beds Activated sludges...	Lagooning free water ponds	Artificial ecosystems EPUVAL
Technical aspects	Footprint - Yield (area - E.H.)	< 1m ² / E.H. 	10 - 15 m ² / E.H. 	5 - 10 m ² / E.H.
	Effectiveness of treatment	MES, DBO5, DCO 	MES, DBO2, DCO, N, pathogens 	MES, DBO3, DCO, pathogens, N, Ppathogens
	Discharge as surface water			
	Interest if there are load variations (organic/hydraulic)	Diluted effluent discharge without purification 	flexible - long stay 	flexible - long stay
	Ease of management, upkeep and maintenance	Qualified staff 	no special qualifications 	no special qualifications

SUSTAINABLE REFURBISHMENT OF SCHOOL BUILDINGS

4. REDUCE WASTE PRODUCTION



Environmental aspects	Use of Chemicals	Flakes, Soda, Bleach, chlorination 	Not advised 	Not advised
	Energy consumption	0.51 to 1.06 kWh/m ³ 	< 0.1kWh/m ³ 	< 0.1kWh/m ³
	Risk of polluting the environment (sub-soil and water)	leakage due to min drains management and maintenance of pipes 	ensure good water tightness of the lagoons 	ensure good water tightness of the ponds
	Useable sub-products from installation	Sludge, methan, bacteria from installation 	Sludge, methan, plant biomass, animal biomass, water after treatment 	Sludge, methan, plant biomass, animal biomass, water after treatment
	Benefit for human and natural environment	Energy production if CH4 used 	Biodiversity, educational aspects, energy production (CH4) 	Biodiversity, educational aspects, energy production (CH4)
Economical aspects	Investment cost	700 to 1200 euros/EH 	350 to 600 euros/EH 	350 to 1600 euros/EH
	Maintenance	400 euros/EH 	15 euros/EH 	30 euros/EH

Source: CERAA - MATRICIEL - www.matriciel.be – Autor : L.Dinaer

4.1.7. Purifying raw waste water

All of the waste water, blackwater and greywater can be purified using extensive techniques, in the form of a succession of several ponds which is known as Agencement d'Ecosystèmes Aquatiques Reconstitués (AEAR) [Reconstitution of Aquatic Ecosystems]. There are various types of layout, the choice depending on:

- the area of land available
- the morphology of the land
- the number of occupants and the volume of waste water

4.1.7.1. Reconstitution of Aquatic Ecosystems – from 2.5 to 10m²/E.H., up to 20 E.H.

These arrangements are of two types:

→ Simple arrangements

Arrangement consisting of a plant filter with vertical or horizontal flow.

The purified water must be discharged into the soil in which tertiary purification (nitrates and phosphates) can be performed.

→ Complex facilities

Facilities consisting of two to four ponds:

- Reedbed on gravel or planted sand filter
- Reconstituted wetland

SUSTAINABLE REFURBISHMENT OF SCHOOL BUILDINGS

4. REDUCE WASTE PRODUCTION



or

- Reedbed on gravel or filter on planted sand
- Lagoon containing microphytes
- Reconstituted wetland
- Discharge: into pond containing native fish

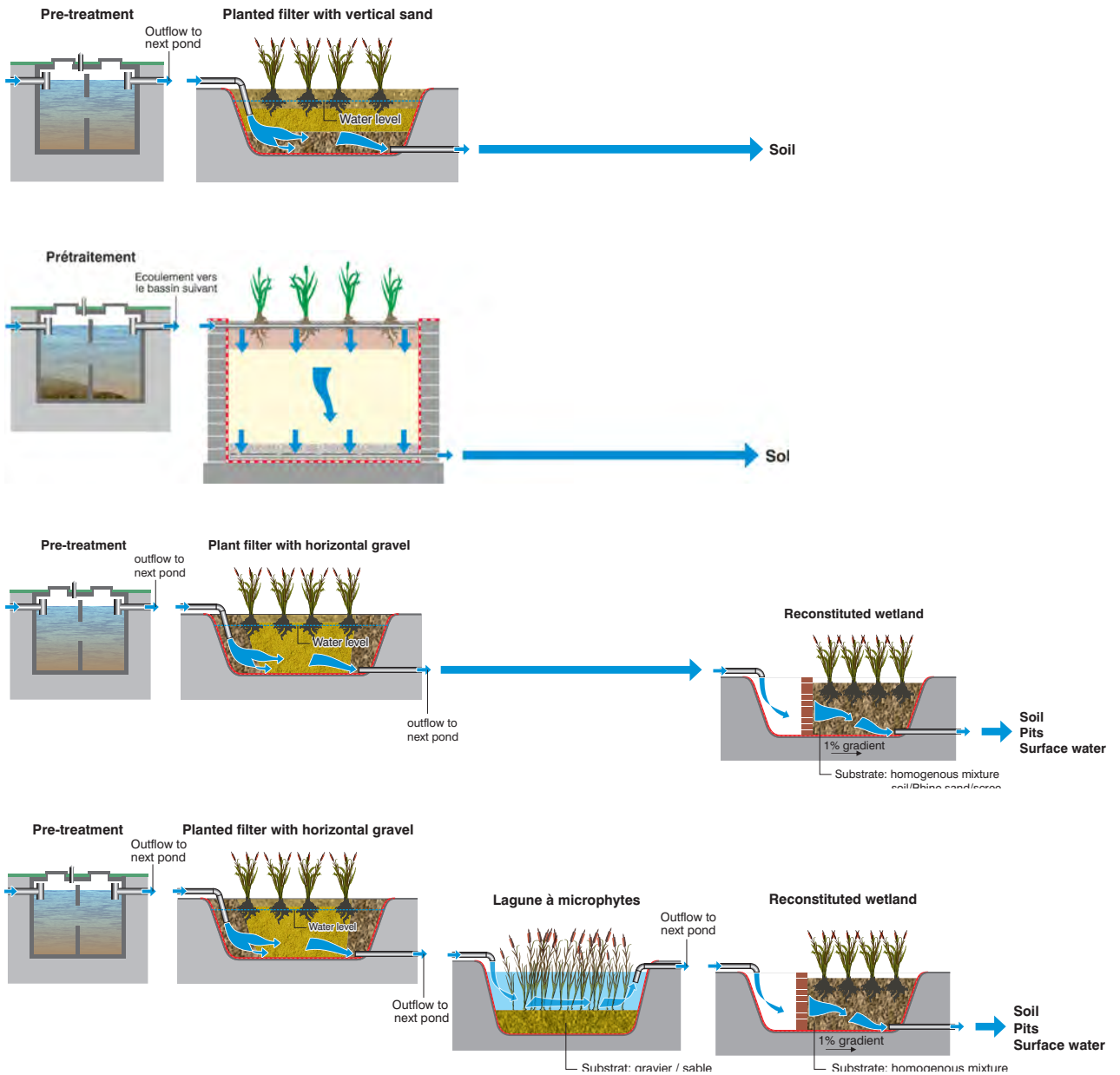

Picture : Catherine Massart



Picture : Catherine Massart

SUSTAINABLE REFURBISHMENT OF SCHOOL BUILDINGS

4. REDUCE WASTE PRODUCTION



4.1.7.2. Other extensive purification systems for raw waste water

→ The EPUVAL process (<http://www.epuval.eu>)

Process developed by the not-for-profit EPUVALEAU organisation and the Gembloux University Faculty of Agricultural Sciences (Belgium). This purification system uses the principles of the Kickuth process for horizontal flow and can purify large amounts of waste water: between 5 and 650 E.H.

4.1.7.3. Mixed systems for purifying raw waste water

Mixed systems combine intensive treatment with a natural treatment. They include:

→ The INCOMATS (Integrated Conventional Macrophyte Treatment System) process

This is a raw waste water purification system that combines conventional treatment (biorotor and activated sludge) with an extensive treatment (ponds containing macrophytes and reconstituted wetlands)

Example:

The Antwerp National Zoo – PLANCKENDAEL:

- purification at 30 m³ per day;

- area covered: 900 m.²

→ The “Sidwell Friends School” (Washington, USA) process

A raw waste water purification system using a biological filter treatment (aerobic fixed biomass) combined with plant filters of reeds installed in the school playground.

- purification of 11.5 m³ per day

- recovery of “recycled” water for use in the toilets and watering the landscaping around the school

→ The “LIVING MACHINE” process

This purification process is conducted in a greenhouse, atrium or a double-skin façade these being considered here as a biological and climatic “shelter”. The principle is presented in the picture below:

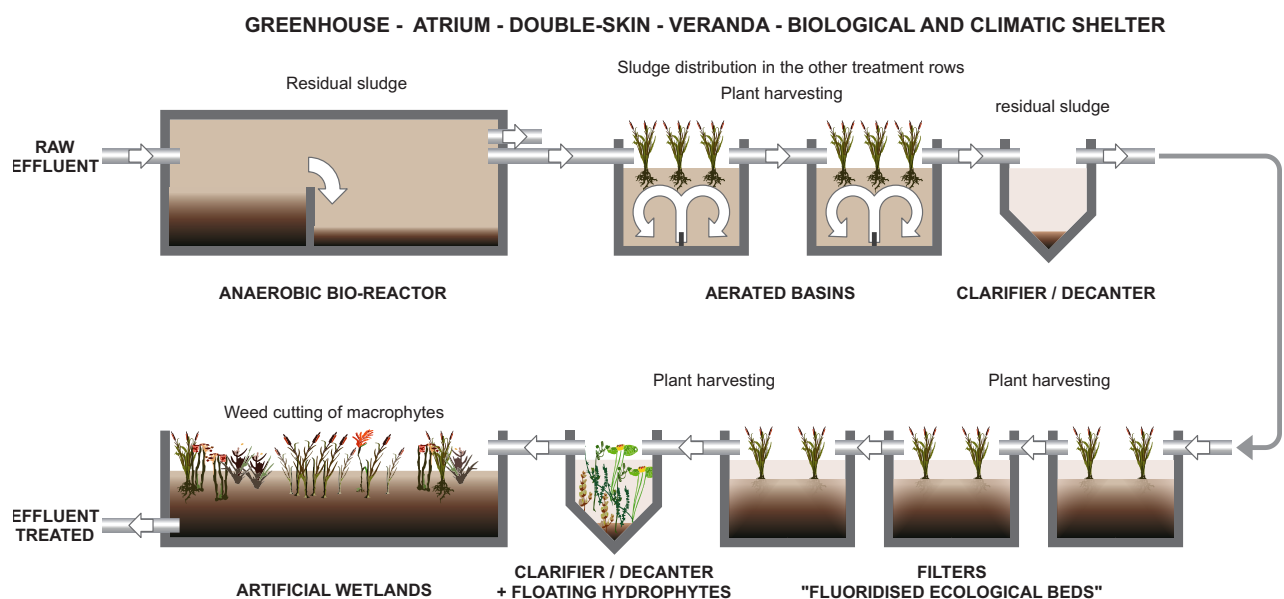

SUSTAINABLE REFURBISHMENT OF SCHOOL BUILDINGS

4. REDUCE WASTE PRODUCTION



4.1.8. Recycling waste water from a school: issues and recommendations

→ Is the terrain suitable for an extensive purification system?

The ideal terrain for the introduction of a purification unit through lagoonage should have the following characteristics:

- a fairly substantial available surface area (> 50m²);
- the possibility of filling the pond or ponds with trees with long trunks at least 5m high;
- stable and sufficiently wide access to install the septic tank, excavating lagoons and adding substrates (sand, gravel, etc.);
- a gradient of at least 60 cm between the waste water discharge pipes and the discharge of water after purification;
- the possible presence of hard rocks at a depth of at least 1 m below the surface of the land.

Note:

Being in possession of land that has little permeability or is even impermeable can represent an economy with respect to waterproofing, because a layer of clay could be used instead of a membrane.

Not all these characteristics need to be present for a lagoonage system to be installed. For example, if the topography of the terrain is unfavourable, it is always possible to install a sump pump but this means allowing for additional expenditure of 1,000 euros.

→ How should the ponds be laid out?

The excavation of the lagoon or lagoons (+ septic tank) will generate quite a volume of excavated soil. In certain cases, this soil can be scattered over the site, otherwise it will have to be loaded into trucks and removed, representing an additional cost for performing the works. The lagoons must always be waterproofed. Depending on the type of pond to be paid out, waterproofing is achieved:

- using internal shuttering and casing masonry blocks (waterproof cementing);
- by installing prefabricated concrete tanks;
- by inserting synthetic membranes (EPDM) placed on a bed of stabilised sand.

Most of the purification ponds should be completely filled with various substrates (sand or gravel).

This characteristic is essential to guarantee the following advantages:

- absence of bad smells
- total safety against the danger of a child falling in the water
- no proliferation of mosquitos.

The substrate in which the aquatic plants are rooted should guarantee:

- good water flow
- good contact between the water to be purified and the roots of the aquatic plants
- the fixing of microorganisms (plankton, bacteria, rotifers, etc.)

→ What pre-treatment is necessary?

Before waste water can be sent to the treatment ponds it must be pre-treated:

- blackwater or sluices are pre-treated in a septic tank
- the greywater is at the very least pre-treated in a degreaser

→ Time taken for the water to be purified

The time the water to be treated remains in the lagoons should be at least equivalent to 30 days . This corresponds to a total area of “ a stretch of water” of about 5 to 7 m²/E.H

→ Waterproofing the ponds

The ponds in extensive treatment systems must be waterproofed in order to avoid any pollution of the water tables. Furthermore, if the ponds are not sufficiently waterproof, they are in danger of never filling with water and thus will not fulfil their purification role.

SUSTAINABLE REFURBISHMENT OF SCHOOL BUILDINGS

4. REDUCE WASTE PRODUCTION



→ Outflow and discharge of purified water

Care must be taken to ensure a good flow of water between the different basins. There should be provision for lagging pipes during periods of frost.

The treated water is discharged into the soil, via:

- an underground spreader bed;
- a pit;
- surface water pipes if it is not possible to resort to the first two alternatives;

→ What about maintenance?

For extensive waste water purification systems to work efficiently it is important to check the whole system on a weekly basis (pre-treatment, lagoons or wetlands), and to correctly maintain the surroundings of the system (cutting surrounding grass, collecting leaves in the autumn, etc.) so that these do not interfere with the extensive system.

Furthermore, it is important to trim back the aquatic plants once a year, in the autumn. This annual maintenance is necessary because, in view of the extent of the plant biomass, the lagoon could soon become choked.

Trimming will also make it possible to extract the minerals (nitrogen and phosphates) that have accumulated in the plant tissues. If trimming is not performed, the plant purification result will be virtually nil. The fact that the lagoon is filled with a substrate makes trimming back the plant risk-free and easy (the trimming from the plants are also easier to collect from the gravel surface).

In the case of free water lagoonage, the removal of sludge that has accumulated at the bottom of the lagoon should be removed every five to 10 years. This is known as a "flushing operation".

Two techniques could be used:

- the first consists in draining the lagoon followed by scraping out the sediment using construction machinery, for example. This will also require the introduction of an waste water bypass while the sludge is being removed.
- the second, which is non-invasive, consists in pumping out the sludge, using a raft that is moved across the surface of the lagoon. This method does not require any change to the usual operation of the lagoon.

It is also important to scrape out the septic tank every two to five years, depending on the amount of consumption and discharge. The degreaser requires very regular maintenance.

Remember:

- To identify the limitations and potential of site installation at a school, favouring the use of extensive treatment techniques
- Choose an extensive treatment process and optimise its size
- Guarantee treatment performance for the chosen system and the quality of water discharged
- Ensure that all parts of the system are waterproof and the various types of sewage pipes and drains are insulated
- Ensure annual maintenance of the plants
- For water discharged after treatment, give preference to infiltration in the soil and/or discharge into a surface network of water pipes

SUSTAINABLE REFURBISHMENT OF SCHOOL BUILDINGS

4. REDUCE WASTE PRODUCTION



4.2. Reducing, managing and using construction and demolition waste



4.2.1. Quantity and distribution of construction waste by country

Country	Inhabitants	Waste production per year	Distribution
France	65.436.552 (2011) <i>Source: World Bank</i>	38,000,000 tons <i>Source: Observation and Environmental Statistics, Investigation of waste produced through construction activity in France, 2008</i>	72.4% inert waste 26.1% industrial waste 1.5% dangerous waste <i>7 % of waste is generated by new construction, 28% by restoration work and 65% through demolition work</i>
Belgium	10.951.266 (2011) <i>Source: http://statbel.fgov.be</i>	18,164,909 tons <i>Source: 2011 figures, http://statbel.fgov.be</i>	83% inert waste
Norway	5.000.000 (2012)	1,540,000 tons (2010) <i>i.e. 18% of total waste produced Thirty-five per cent (0.54 million tonnes) of the total waste generated from building activities in 2010 came from rehabilitation activities. Construction activities generated 34 per cent (0.52 millions tonnes), and demolition generated the last 31 per cent (0.48 million tonnes).</i>	40% inert waste 18% industrial waste 14% waste timber 14% asphalt waste
Italy	60.626.442 (2011) <i>source: Itstat</i>	56.700.000 tons of non-dangerous inert waste in the construction sector (2009)	Total inert waste: around 50 million tons Not recycled : 37 million tons (2011)

Figure 3.2 Waste streams in the EU-27 and Norway by type of waste

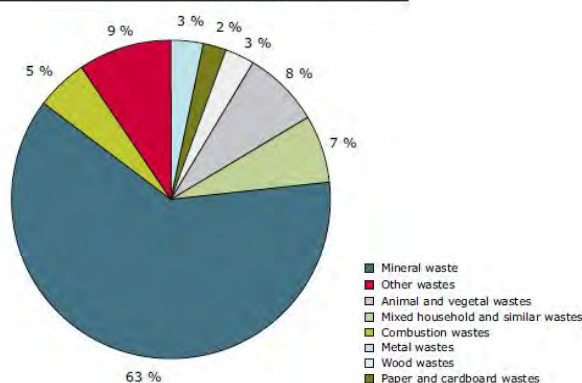

Source: Eurostat - Data Centre on waste 2010

Figure 3.1 Total waste generation in the EU, EFTA, Turkey and Croatia in 2006 by source

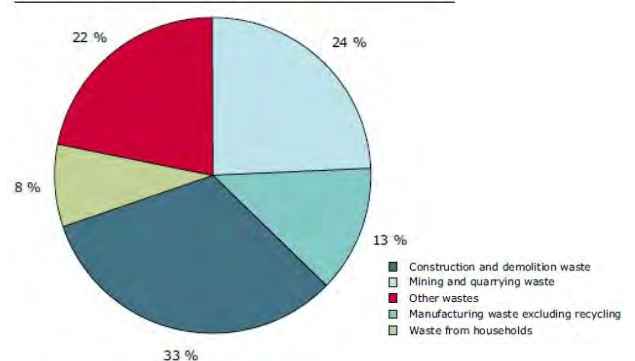

Source: Eurostat - Data Centre on waste 2010

SUSTAINABLE REFURBISHMENT OF SCHOOL BUILDINGS

4. REDUCE WASTE PRODUCTION



4.2.2. Preventive measures: reduction at source

To optimise waste management from building sites and their re-use, it is important to reduce waste production at renovation sites and improve sorting to enable the recovery of the “cleanest” possible materials and their recycling.

Renovation work inevitably involves a large volume of construction waste from both the demolition work and the new works.

In terms of sustainable renovation, it is therefore important to use three main guidelines so as to limit the amount of waste created and waste incinerations:

- Prevention, i.e. reducing construction waste to a minimum at a renovation site and during future conversions or demolition of a building using certain preventive measures such as the choice of construction process, choice of construction materials and choice of implementation at the site;
- Added value, i.e. promoting recycling and the re-use of demolition waste through optimum sorting thereof on-site;
- The elimination, when added value is not possible, via two routes: incineration with additional energy value and sending to landfill (to be reduced to a minimum).

4.2.2.1. Preventive measures during the design phase – building’s adaptability

Right at the start, a check should be made to see whether the existing building (s) are suitable for accepting and incorporating the plan and functions desired depending on its/their features: area, ceiling height, division of spaces, distribution of openings, etc.

The designer should then ensure, at the design phase:

- that a renovation is offered that rationalises the use of materials and/or reuses certain existing materials and elements;
- designing a building whose modules can be changed over time, enabling the introduction of new functions, internal restructuring and/or extension without generating a large volume of waste.

Ability of building to adapt	
The adaptability of a building translates into its capacity to experience changes without altering its use or the services it renders, the changes being those that must be performed sustainably and with the least environmental costs (waste, raw materials, energy)	
Flexibility	The flexibility of a building is measured by the ease of restructuring its interior spaces. This assumes it is constructed in a modifiable plan, with internal structures that can be dismantled and easily accessible utilities.
Elasticity	Elasticity is the ability to extend a building. Elasticity assumes a special consideration of the overall plan, the volumetry and the interior layout as well as the construction system used for the façades
Upgradeability	Upgradeability is the ability of a building to incorporate upgrades or innovations as well as through its technical performances and lifestyles.
Neutrality	Neutrality is the ability of a building to accept a major change of use. This assumes special works on the volume and technical and structural cores of the building.

Source: “Qualite environnementale des bâtiments” [Environmental quality of buildings], Ademe

4.2.2.2. Preventive measures to be applied to the construction process (for an extension project)

The construction process and construction choices should make it possible to reduce to a minimum the construction waste produced at the renovation site.

In order to achieve this, the designer should ensure:

- to promote prefabrication of construction elements wherever there are real and usable advantages in doing so (depending on the size of the project, where it is located, the complexity of transport, etc.). This solution also makes implementation easier (no measuring and cutting out at the site) and a significant reduction in the time taken for the construction;
- using pre-installed elements of standard size in accordance with the structural dimensions of the buildings in order to prevent any cutting out at the site and thus waste production;

SUSTAINABLE REFURBISHMENT OF SCHOOL BUILDINGS

4. REDUCE WASTE PRODUCTION



Pictures © Atelier Alain Richard AA- AR

Pictures © infobois

- ensure the reversibility of fixtures and fitting between the various components of the prefabricated item and between the prefabricated item and its supporting structure (structure of the building) to make it possible to remove it for recycling purposes and in order not to change parts of the building that will subsequently be kept as they are. Mechanical assemblies, as opposed to assembly using adhesives makes it possible to:
 - easily remove the various material assembled
 - sort them easily
 - achieve a higher rate of recycled materials (to be sent to the various recycling outlets)

4.2.2.3. Preventive measures in the choice of construction materials (for the renovation project)

The choice of materials made during the first stages of the renovation process could have more or less significant consequences, at the end of life, or in relation to the quantity of waste products and their management in terms of enhancement or removal.

In general:

- materials or products that produce dangerous waste should be excluded;
- consider reusing certain waste items at the site without prior processing.

With respect to the choice of materials, the architect must ensure that:

- he/she takes an interest in the local and/or regional waste and recycling market so as to familiarise himself/herself with recyclable materials and the way they are chosen and to combine materials depending on their recycling classification;
- favour the use of recyclable materials and those actually recycled in the local market (prior preparation work);
- choose the materials by prioritizing the possibility of direct re-use or re-use after making good or of recycling;
- checking the composition of materials, the origin of raw materials and compliance with eco-labelling;
- promoting reversible attachment techniques so as to keep materials separate from each other and enable the recovery of materials that can be used again.

4.2.2.4. Preventive measures when using new materials and construction elements

Implementation making it possible to avoid the production of waste, reducing the quantities thereof and promoting re-use and recycling in order to drastically reduce the use of landfill or incineration centres are based on the principle of reversibility:

- use attachment systems that make it possible to dismantle and reassemble the constituent parts so that the materials can be recovered (re-use/recycling) and ensure easy access for upkeep and maintenance;
- avoid the use of composite materials or combinations of materials that cannot be removed or dismantled and thus not enabling the separation of materials for recycling purposes;
- in the case of a combination of materials, ensure that recyclable materials are used that belong to the same class of waste;
- ensure the accessibility of the attachment systems to enable their subsequent removal

The quality of implementation will considerably affect the sustainability of the parts and construction materials.

For the purpose of their optimisation, the architect should ensure:

- that when the materials are used they should be protected from deterioration from outside elements (rain and humidity) – for new materials and recovered materials;
- compliance with the manufacturer's recommendations or those stated in the standards in order to avoid sub-

SUSTAINABLE REFURBISHMENT OF SCHOOL BUILDINGS

4. REDUCE WASTE PRODUCTION



sequent deterioration;

- a good understanding of the information provided to the contractors and all the building trades concerning the techniques to be implemented and the performance objectives;
- the good organisation and coordination of the site mainly for works that require the intervention of successive building trades – in order to prevent unsuitable implementation or deterioration;

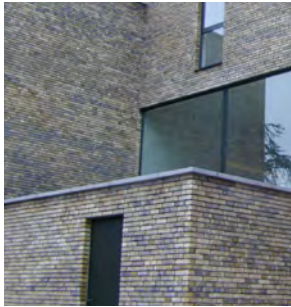

Picture: Architecture et Climat

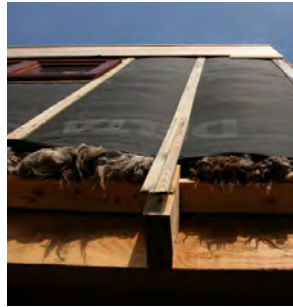

Picture: © Calimucho.be



Picture: Architecture et Climat



Picture: Architecture et Climat

- awareness of the building workers of the situation by informing them of the challenges involved in the proposed method of construction and fix the requirements.

When the building work is progressive, modifications will always need to be made with respect to the choice of materials and assemblies. In this case, it is important that such modifications are transcribed accurately into the working documents.

4.2.3. Manage waste and give it added value at the site

The recycling industry is expanding rapidly. It is therefore important to make the best use of waste depending on the existing local processing outlets:

- introduce differentiated waste management at the site and organise sorting into different categories / proportions of waste “in situ” (mixed waste is always more expensive to remove from the site)
- identify existing reprocessing outlets at less than 30km from the renovation site, prioritising “materials” added value over energy value or storage at a technical landfill
- collect sufficient information (nature of the waste product, type of waste accepted and cost of removal, depending on the outlet) for the purpose of re-use.

Efficient waste management makes it possible to do more waste sorting and doing so at source so that it can be re-used at the recycling outlets. Efficient management of demolition waste at the site involves working in five phases:

- the identification of different materials incorporated in the existing building and liable to become a waste;
- the selective dismantling (rather than demolition) of various materials;
- sorting the waste, according to the legal obligations specific to the country or region, depending on local conditions and the organisation of the site;
- the choice of added value outlets or if not available, elimination outlets;
- the identification of outlets.

4.2.3.1. Waste value added outlets

Adding value consists in restoring a saleable value to waste: waste is considered to be a resource to be used and not as rejects that must absolutely be disposed of.

The value added outlets for construction waste make it possible to maintain added value per person for the material based on the following categorisation:

→ “Materials” valuation

- the preservation and re-use of an item, product or construction material, where it retains its initial function;
- the re-use of a construction element, product or material using it elsewhere or for a different purpose than the one for which it was used initially;

4. REDUCE WASTE PRODUCTION



- the recycling of a construction element, product or material: the item, product or material is introduced into the production cycle from which it issued to replace a “new” raw material;
- the recycling of a construction element, product or material: the element, product or material is introduced into a production cycle for quality products, those of value or having lower technical requirements.

→ “Energy” value added

A construction element, product or material is converted into fuel: the calories in the item are recovered through burning and recovering the energy.

→ “Organic” value added

A construction element, product or material is composed or biodegraded: the organic matter is converted by a natural biological process through the effect of oxygen. The substance thus converted is returned to nature in the form of fertiliser or “feed”.

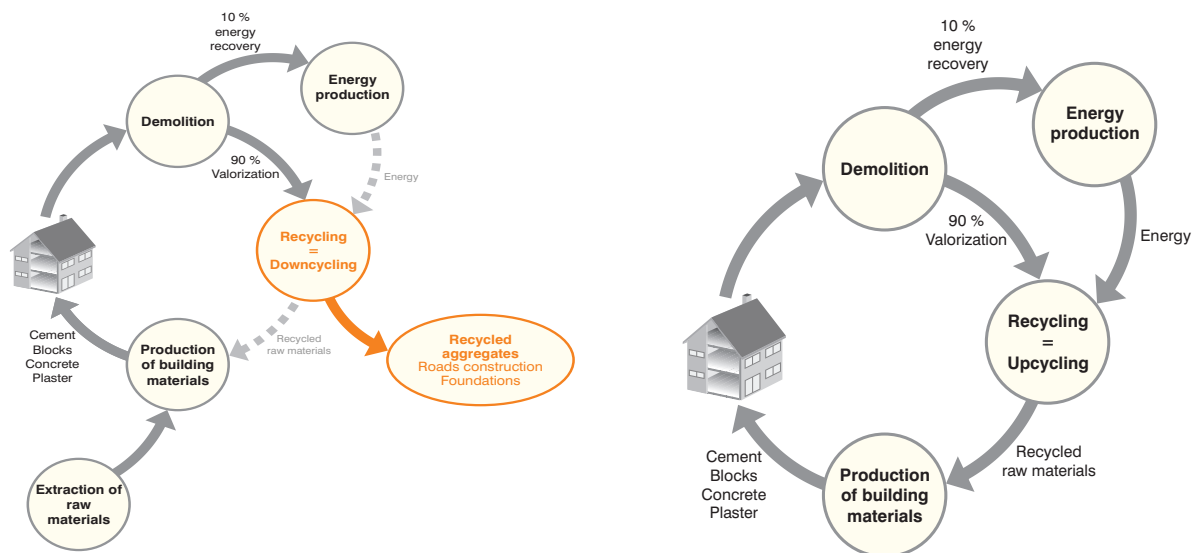

Note:

If the energy and organic value added makes it possible to substantially reduce the quantity of waste products to process, they nevertheless do not make it possible to give a new existence to used materials. In other words, they close a life cycle without leaving the possibility of commencing a new cycle. The outlets using the materials all have a policy of the so-called “three Rs”:

- reducing construction waste at source;
- reusing construction waste;
- recycling construction waste.

Prevention and/or reduction is the guiding principle. This reduction and prevention principle is also the very basis for any environmental or sustainable policy: limiting nuisance, limiting risk, reducing impact, etc.

4.2.3.2. Downcycling and upcycling, an important shade of meaning

In terms of value added “materials”, it is important to distinguish between “downcycling” and “upcycling” as shown in figures below for the case of inert waste. These two added-value processes offer three major “ecological” advantages:

- reduction in the volume of waste, and thus in its potential for pollution caused to the environment;
- the preservation of natural resources, since the recycled material is used instead of raw materials that would otherwise have been extracted;
- the conservation of energy resources, since in most cases, the manufacturing process that uses recycled materials have a less significant energy need than a manufacturing process that uses raw materials.

4. REDUCE WASTE PRODUCTION



→ Downcycling

Down cycling is a process that uses a construction product or material as a secondary substance for the production of a new material or quality product, value product and/or one with a lower technical requirement.

Example:

This is the case with crushed concrete that is used as a material for embankment or foundations under a road, although in certain conditions, it could be used as aggregate in the production of new concrete. This is also the case with items made of untreated wood that are used in the manufacture of particle board (MDF, OSB etc.).

This value added re-use is currently employed to a great extent by many manufacturers of construction materials who have realised the economic advantage of using recycled secondary raw materials:

- the manufacturers of fibreglass use between 30 and 80 % of recycle glass in their manufacturing process;
- the manufacturers of cellular glass use up to 60 % of recycled glass in the manufacturing process;
- the manufacturers of plaster-based products are using more and more sulfogypsum or phosphogypsum resulting from the precipitation of calcium sulphate in different industrial processes, etc.

This value added outlet has the advantage of significantly reducing the amount of waste to be managed and reducing it in various industrial procedures as a secondary raw material. However, this type of value added often gives the product a single added life cycle closure.

→ Upcycling

Upcycling is a treatment process through which a construction item or material is introduced into the manufacturing process from which it originally emerged, as a replacement for a raw material. Upcycling has the advantage of being able to close the lifecycle of a material several times and launch the following cycle.

Note:

As part of a sustainable resource management policy, added value outlets should be encouraged. These outlets require some preparatory work in advance, however, during design, implementation and demolition of the architectural project.

4.2.3.3. Objectives of on-site waste management

→ Preserving the environment

Waste recycling enables considerable economy in natural resources and restricts pollution by use of landfill or fly-tipping.

→ Creating economies for the site

Good waste management on-site makes it possible to significantly reduce the cost of waste removal. Reducing site nuisance. Good waste management makes it possible to restrict the visual impact, waste and dust flying away, etc.

→ Improving site working conditions

A tidy site, without waste being left on the ground, makes it possible to improve working conditions, make tasks less onerous and increase production.

4.2.3.4. Pre-study for waste management

→ Site analysis

A site analysis will take account of the following information:

- **Accessibility:** identification on-site, of any restrictions on waste removal and the supply of materials.
- **Immediate surroundings:** identification of the neighbourhood and activities sensitive “to building site nuisance” to be incorporated into site organisation and management.
- **Space organisation:** identification of potential storage areas depending on accessibility and the immediate environment.

SUSTAINABLE REFURBISHMENT OF SCHOOL BUILDINGS

4. REDUCE WASTE PRODUCTION



→ Building inventory and the components to be dismantled

Inventory of the existing building and its components should cover the following information:

Type of materials	Unit of measurement	Quantity to be removed
Identification of various materials or components by providing information about the colour, material, size, make, marque or model as well as the condition.	Pce, mc, m ² , m ³	To be calculated in kg or tonnes. Makes it possible to quantify the costs of removal or enhancement as well as the costs connected with transport.
Makes it possible to establish the various fractions of waste : inert, metal, wood, etc.).		

Ideally, such an inventory should be accompanied by photographic addenda so as to be able to clearly identify those items that could be re-used on-site or in which a potential buyer might be interested.

→ Assessing waste generated by the site

The construction enterprise needs to assess the quantity of waste liable to be produced at the site (dismantling and construction) by type of materials used as well as the quantity of waste produced in the life of the site (offices, canteen, etc.). This assessment should be made per inspection of demolition work, on plans for extension or enlargement works (newbuild). The assessment should cover all types of waste, the quantity and location thereof. This data could also be entered into an Excel spreadsheet.

→ Identification of directly reusable waste at the site, recyclable or usable waste and so-called “ultimate” waste

→ Analysis of various recycling or added-value outlets (the closest geographically)

Analysis of the various added value and elimination outlets will show:

- **Where the various outlets are located**

So as to reduce to a minimum the environmental and economic impact connected with transport, the closest outlets to the site should be chosen.

- **The quality required of the materials to be re-used**

- **The cost of the outlet (per m³ or per tonne)**

At present, certain value added outlets purchase construction waste. This is the case in particular with all outlets connected with metallurgy.

- **What becomes of waste in cases of added value**

Asking what will become of waste in the case of added value makes it possible to trace it. An analysis of the outlets will prioritise recycling then enhancement outlets and finally controlled elimination.

→ Estimate of management costs

In addition to the costs involving added value and the transport of waste, the costs connected with site management will need to be assessed:

- Handling costs
- Labour costs
- Cost of renting pavement and road space

SUSTAINABLE REFURBISHMENT OF SCHOOL BUILDINGS

4. REDUCE WASTE PRODUCTION



- Cost of container hire

→ Management Plan

Before the site is opened, the construction/renovation firm must set up a management plan based on prior studies and the chosen outlets:

Fractions	Planned quantity	Container	Transport			Processing		Total
	m ³	pce (+/- 20 m ³)	ton	price per ton	total	price per ton	total	
Structural work								
Inert recyclable	8 849	443	12 157	105	1 276.485	9	109 413	1 385 898
Inert non recyclable	80.2	4	192.9	105	20 254	50	9 645	29 899.5
Stone (white)	192	10	461	0	0	-2 300	-1 060 300	-1 060 300
Stone (blue)	178	9	427.2	0	0	79.5	33 962.4	33 962.4
External finishing								
Copper	3	1	26.7	0	0	-1 300	-34 710	-34 710
Aluminium	0.7	1	1.8	0	0	-930	-1 627.5	-1 627.5
Glazing	155	8	252	105	26 460	-17	-4 284	22 176
Internal finishing								
Rockwool	263.4	13	65.9	105	6 919.5	120	7 908	14 827.5
Plasterboard	33.6	2	53.8	105	5 644.8	23	1 236.5	6 881.3
Marble	25.9	2	70	0	0	-473.5	-33 145	-33 145
Linoleum	48.2	3	57.8	105	6 069	50	2 890	8 959
Fitted carpet	43	2	77.4	0	0	0	0	0
Panelling	73.9	4	37	105	3 885	10	370	4 255
Tiling	11	1	18.7	105	1 963.5	9	168.3	2 131.8
Misc.								
Wooden doors	810	0	0	0	0	-103.4	-83 754	-83 754
Sanitary fittings	732	0	0	0	0	-74	-54 168	-54 168
Lighting and lamps	894	0	0	0	0	-50	-44 700	-44 700
Hydrant	54	0	0	0	0	-524	-28 296	-28 296
Boiler	3	0	0	0	0	-1 850	-5 550	-5 550
Wooden shutters	30	1	1.5	105	154.4	50	73.5	227.9

Example of management plan - Source: S. Trachte

4.2.3.5. Management of waste at the site

→ Training to sort materials at the site

Sorting on-site and selective demolition cannot be successfully performed unless all those working at the site are convinced of the usefulness thereof.

For this purpose, it is useful to:

- **Train, make aware and involve the workers at the site**

The first people involved in construction/renovation/demolition are workers present on-site. Waste sorting operations have not been totally incorporated in the habits and practices of the site. It is thus indispensable to sensitise and encourage site workers to recycle, keep the site clean and sort waste.

Workers at the site also need to be trained in selective demolition and sorting. In order to do so, rapid on-site training is indispensable, and this should include the following information:

- the types of fractions to sort and the storage area;

SUSTAINABLE REFURBISHMENT OF SCHOOL BUILDINGS

4. REDUCE WASTE PRODUCTION



- the way to perform selective demolition;
- labelling the containers;

Sub-contractors must also be involved in the management be encouraged to sort waste.

• Appointing a “waste” manager for the site

It is essential to appoint a “waste” manager if sorting is to be effectively performed on-site. The manager will be responsible for ensuring:

- checking the quality of sorting;
- continuous sensitising of the workforce and sub-contractors;
- correction of any sorting errors;
- supervising the level of container filling;
- correct removal and destination of sorted waste.

→ Introducing sorting arrangements at the site

The introduction and management of the skips for sorting materials on-site is a necessary factor in the efficient organisation of waste sorting and through doing so its recycling or added value. It is preferable to use one container per type of waste.

• Setting up the containers at the site

An analysis of the building site makes it possible to allow the necessary space for the containers to be introduced. Skips should be provided depending on the type of site, the quantities of waste produced and the space available.

Note: In the case of schools, as a safety measure, it is recommended not to put skips in play areas and recreation areas unless the deconstruction work is being performed in the school holidays.

They should all be placed in the same area and as follows:

- close to roadways to facilitate their removal;
- close to the building site so as to reduce distances and the crossing the site;
- easily accessible to all workers.

If the space is narrow or there is a shortage of room, the following solutions could be considered:

- compartmentalising containers;
- temporary storage inside the building, close to an exit – storage in builders’ rubble bags or a small container;
- transfer of waste to a sorting centre.

Note: The greater the number of skips, the more the waste is correctly assessed or recycled (it is assumed that the sorting will be performed)

• Packing and labelling the containers

Packing and labelling the containers ought to facilitate sorting and the work of all those working at the site.

Packaging should be thought out in relation to the type of waste to be stored:

- light items: large containers;
- heavy items: builders’ rubble bags or small containers

Skips should be correctly marked in order to prevent sorting errors and encourage sorting. The containers should carry exact indications of what they may or may not contain:

- labelling in the form of information panels (written text and pictograms);
- labels to be stuck on accepted items in the container.

• Protection of containers

The containers must be protected against:

- fly-tipping (by neighbours and neighbouring building sites);
- bad weather (wind, rain, etc.);

Tarpaulins can be used to cover the containers, or containers with a lid can be used.

→ Checking and monitoring waste removal (including dangerous waste)

It is not enough to sort the waste on-site, it must reach its destination and the outlet for which it was sorted. That is why the project designer and project owner must ensure that specific documents and invoices for the transport and treatment of waste are monitored, checked and retained by the firm.

The firm must keep the following data:

SUSTAINABLE REFURBISHMENT OF SCHOOL BUILDINGS

4. REDUCE WASTE PRODUCTION



Pictures : Sylvie Rouche and Sophie Trachte

- the transport order: date, manager, forwarder, type of skip, type of waste, destination
- the consignment: date of consignment, forwarder, mode of transport, type of skip, waste, destination, amount of invoice
- processing: date of receipt, installation, waste, volume, type of processing, amount of invoice
- accounts department: date, manager, date of consignment for payment

The acceptance agreement when the building work is complete will require proofs of inspection and monitoring of waste removal. The company must provide the project owner with the specific documents and invoices relating to the transport and processing of waste.

4.2.3.6. A few possible destinations for construction and demolition waste (for information)

→ Classes of construction waste

• class 1: dangerous industrial waste

Dangerous waste is waste that represents a specific danger to humans or the environment. These types are identified and listed and should be labelled. This waste must be collected by an approved collector and transported by a licensed forwarder. It is processed at a technical landfill centre (TLC) for dangerous waste.

Example: asbestos, asphalt (containing pitch), certain types of treated wood, certain lacquers and paints, synthetic mastic, any product containing dangerous substances, etc.

Certain specific types of dangerous waste are the subject of special regulations. That is the case with PCBs, used oil, asbestos, batteries and accumulators, etc.

• class 2: household waste and similar items and non-dangerous industrial waste

This waste is non-inert but also not dangerous. It is collected by the contractor at the site then transported by an approved forwarder or by the contractor to a TLC for non-dangerous waste. This waste can also be sent to recycling centres.

Example: untreated wood waste, fibrocement roof tiles, certain vegetable glues, packaging waste, synthetic insulation that is based on plant or animal fibres, ferrous and non-ferrous metals, etc.

• class 3: inert waste

European directive 1999/31/CE of the Council of Ministers dated 26 April 1999 defines inert waste as waste that has not been subjected to any significant physical, chemical or biological transformation. Inert waste does not decompose, does not burn and does not produce any other physical or chemical reaction. It is not biodegradable and does not cause the deterioration of any other materials with which it comes into contact, in such a way as to cause pollution of the environment or be harmful to human health. This waste is collected on-site by the contractor and transported by an approved forwarder or the contractor to a TLC for inert waste or to crushing or recycling centres.

→ A few possible destinations

Each fraction or type of waste may be directed to different infrastructures depending on the level of cleanliness of the waste, its recyclability, the quality of sorting performed on-site and the desire for added value.

• INERT waste (class 3) may be sent to :

- A platform for adding value to inert waste;
- Crushing centre;
- Industrial downcycling facilities – making embankments for foundations,
- Industrial recycling facilities – manufacturing new concrete...
- To be avoided: sending to class 3 landfill

SUSTAINABLE REFURBISHMENT OF SCHOOL BUILDINGS

4. REDUCE WASTE PRODUCTION



1. Waste class 1: painting
2. Waste class 1: asbestos
3. Waste class 2: plastics
4. Waste class 2: cardboard and wood
5. Waste class 3: inerts
6. Waste class 3 : concrete
7. Crushing center

Pictures : Sylvie Rouche and Catherine Massart

• **Household waste and similar and non-dangerous industrial waste (class 2) can be sent to:**

- A grouping and sorting centre;
- An energy value facility (power stations, cement works, etc.);
- Industrial recycling outlets (plastics, wood, metal, glass, etc.);
- Class 2 landfill.

→ **Information about the cost of waste management – the Belgian example**

Type of waste	Elimination - 2000	Elimination - 2007	Recycling - 2007
	euros/ton	euros/ton	euros/ton
Concrete (class 3)	12 to 50	14 to 30	
non reinforced - clean			0
non reinforced - dirty			2.5 to 7
reinforced, clean, small calibre			1.24 to 10
heavily reinforced, large calibre			10.20 to 17.40
Masonry (class 3)	12 to 50	14 to 30	
clean debris			5.50 to 20
debris with other waste			9.20 to 20
Asphalt	12 to 124	130 to 170	2 to 15 according to the calibre and if mixed
Debris containing pitch	12 to 124	130 to 170	155 to 200
Cellular concrete	12 to 124	130 to 170	65 to 180
Gypsum board	12 to 124	130 to 170	70 to 150
Wood	83 to 124		
wood class A		14 to 30	0
wood class B		130 to 170	13 to 30
Metals (class 2)			
iron	83 to 124	130 to 170	+ 120

SUSTAINABLE REFURBISHMENT OF SCHOOL BUILDINGS

4. REDUCE WASTE PRODUCTION



aluminium	83 to 124	130 to 170	+1080
zinc	83 to 124	130 to 170	+1400
stainless steel	83 to 124	130 to 170	+1600
Glass (classes 2 and 3)			
single clean plate glass	12 to 50	14 to 30	+15 to +45
mixed glass	83 to 124	130 to 170	25 to 75
Plastics (class 2)			
PVC	83 to 124	130 to 170	0

Source: Brussels Environment - www.ibgebim.be

4.2.3.7. Riva Bella school refurbishment - concept of reuse

The Riva Bella school is an existing semi-prefabricated building, built in 1970 and renovated in 2010/2012. The renovation program combines two educative functions, similar but distinct in one building.

The main objective of the refurbishment process was to **renew** i.e. **making new building by reusing and transforming**:

- Conservation of the metallic structure
- Reuse of many existing components and materials: metallic structure, concrete floor, partition walls, flooring materials, steel panels ...
- Demolition waste management during the retrofitting works : recycle building waste as much as possible
- Use a maximum of prefabricated components and materials : prefabricated insulated wood elements for façade

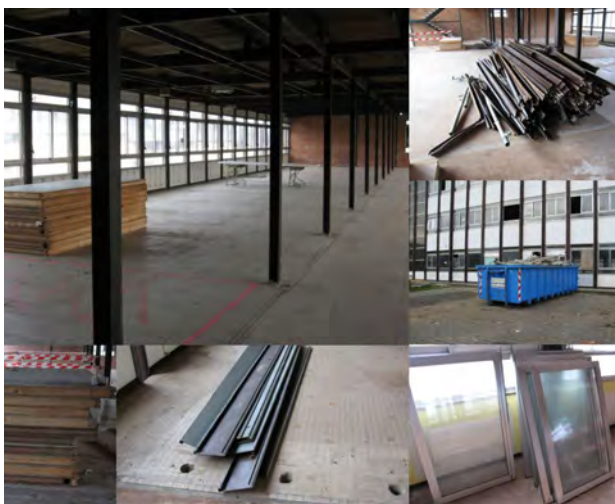
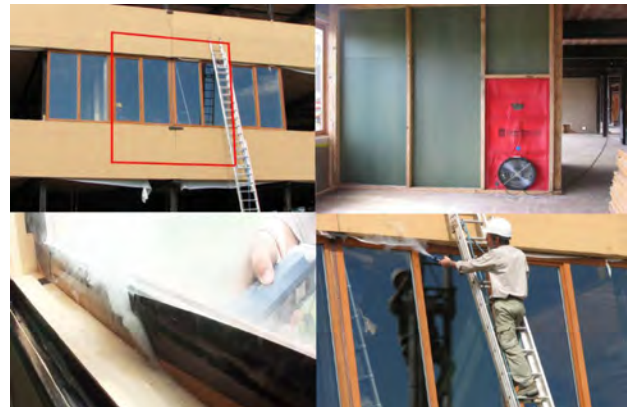

Pictures © Atelier Alain Richard AA-AR

4.3. Reducing, managing and added value from functional (household) waste



4.3.1. Waste production in schools

In Wallonia, the annual production of household waste reached just under 2 million tonnes in 2008, a ratio of 527 kg per inhabitant per year in 2008. Waste products in a school can be compared to domestic waste. They consist mainly of:

- waste paper and cardboard connected with various activities in class
- domestic waste from meals and snacks for the children and teachers:
- organic waste, plastic waste, PMC, glass, etc.
- green waste connected with maintenance work in the open spaces and green spaces around the school
- a few small items of dangerous waste such as batteries, paint, lacquer, etc.

Each pupil in Wallonia produces an average of 14.3 kg annually of waste connected with the school (school supplies, cartridges, meal wrappings, etc.). More than 30 % in weight and 50 % in volume of our waste bin consists of packaging.

4.3.2. Reducing waste at source – behaviour to adopt

Reducing waste at school is mainly a matter of behaviour and the internal policy of the educational establishment; the designer or architect has very little room for manoeuvre on this subject at the time of a renovation project. For good waste management, prevention is a priority but it is obviously impossible not to produce waste at all.

The following stage consists in sorting the waste which was unavoidable for the purpose of recycling or treating it.

4.3.2.1. Waste reduction policy

Each school, each headmaster or headmistress and every teacher can sign up to a waste reduction policy, especially by taking the following actions:

- “No waste action day” with an awareness-raising campaign as to the importance of sorting and the recycling possibilities;
- collective meals by class, making it possible to reduce packaging waste;
- making the children aware of the use of gourds or water bottles, sandwich boxes, fruit or biscuit boxes;
- make children aware of waste sorting at the end of meals (organic waste in one place, packaging waste in another place, etc.).
- starting a compost heap at the school for all organic waste;
- setting up a system in the school of picking up small items of special waste (batteries, printer and photocopier cartridges, mobile phone batteries, etc.) and sending them to the right reprocessing centres;
- setting up a system in the school of an exchange for school stationery or a group purchasing system for school stationery so that the school can choose recycled paper products, etc.

4.3.2.2. A “waste” inventory in each school

If all those involved in running a school want to launch a waste reduction policy, it would be interesting to assess the quantity of waste produced by the school in one day, one week or one month with the help of a waste inventory.

A “waste” inventory makes it possible to be both aware of the amount of waste produced by the school in a predetermined period and identify the types of waste to be eliminated and reduced as a priority.

This “waste” inventory can be run by some of those involved in the school, ideally a teacher and his/her class.

The stages of the inventory are as follows:

- choose several locations that are typical or classified as typical or representative
- remove the sorting waste bins for these various locations

SUSTAINABLE REFURBISHMENT OF SCHOOL BUILDINGS

4. REDUCE WASTE PRODUCTION

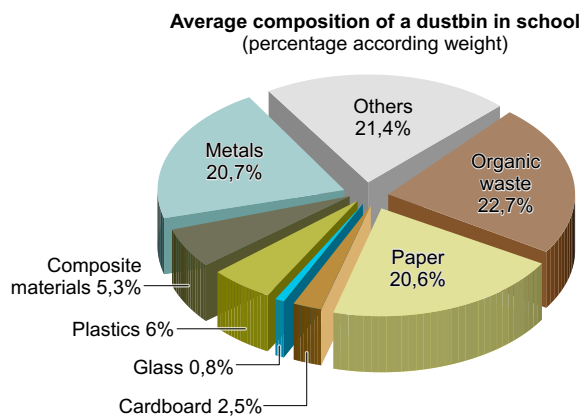

Picture © pedagogie.ac-toulouse.fr

- list, identify and weigh the waste collected
- show the results of the investigation and circulate them in the school
- devise and set up an awareness campaign and slogans that will encourage people to produce less waste.

Note: this activity requires a certain amount of caution and a minimum of precautions especially the wearing of gloves when handling waste.

4.3.3. Managing and making good use of functional waste

4.3.3.1. Principles for managing domestic or similar waste

In order to sort well, the children, teachers and school staff need to:

→ Clearly understand the sorting instructions

In order to do so, it is important to prioritise direct and explicit information, not merely passing directly to putting up notices or posters:

- teachers talking directly to the children in class and supervisors talking to them in the playground, or having any other person close to the daily life of the children in school (gatekeeper, janitor, etc.);
- labels or signs on all the equipment;

Note: it would also be valuable to launch a typical school project, etc.

→ Have the right resources available encourages the sorting of waste

So that children can correctly sort their waste, the children, teachers and staff at the school need to have available:

- a sorting space that is part of the kitchen and the dining-room;
- a set of sorting waste bins in each playground;
- a sorting area in each classroom or in a space shared by several classes;
- a shared storage space adapted to the needs of the collective, well-maintained and easily accessible.

It is at this level that the architect has an important role to play, especially in the interior design of the classrooms and similar areas of a school.

4.3.3.2. Containers or skips

An item of equipment that is clearly identified, well adapted and that makes the task easier facilitates the task of the sorters and collectors and is a factor that encourages sorting.

→ Type of container or waste bin

The choice of containers depends on the following:

- adaptability to volumes of waste and frequency of collection

SUSTAINABLE REFURBISHMENT OF SCHOOL BUILDINGS

4. REDUCE WASTE PRODUCTION



- adaptability to the dimensions of the site or space (dining-room, kitchen, classroom, playground)
- restricting sorting errors
- ease of use by the children (height, manoeuvrability, ease of opening, etc.)
- ease of maintenance

Note that small containers are easier to use and more movable than big containers.

→ Signage or labeling

Each container must be clearly identified by type of waste collected; there should be lids of identical colour to the collection sacks, the container should be labelled with the sorting instructions and/or options and the recycling circuit (especially for cardboard, glass, plastic, etc.)



Picture : Catherine Massart



Picture : Catherine Massart



Picture : Sylvie Rouche



Picture : Sylvie Rouche

SUSTAINABLE REFURBISHMENT OF SCHOOL BUILDINGS

4. REDUCE WASTE PRODUCTION



4.4. Reduce waste production - Breeam assessment method

To assess the issue «Reduce waste production», BREEAM assessment method proposes various criteria mainly listed under two environmental sections

- section « **WATER** » with a weighting of 6 % in the evaluation

This section has been presented in the booklet section 3 « Reduce non energy resources consumption»

- section « **WASTE** » with a weighting of 7.5 % in the evaluation

- WST 01: Construction waste management
- WST 02: Recycled aggregates
- WST 03: Operational waste

Therefore, an overview of these criteria is presented below.

For additional information : <http://www.breeam.org/page.jsp?id=381>

4.4.1. WST 01 - Construction waste management

This issue aims to promote resource efficiency via the effective management and reduction of construction waste.. This issue is **mandatory** to achieve a minimum standard and is split into two parts: Construction resource efficiency (3 credits) and Diversion of resources from landfill (1 credit)

Criteria	Number of credits	Explanation																		
Construction resource efficiency	up to 3 credits	<p>Non-hazardous construction waste (excluding demolition and excavation waste) generated by the building's design and construction meets or exceeds the following resource efficiency bench- marks:</p> <ul style="list-style-type: none"> - 1 credit: for an amount of waste generated per 100m² (gross internal floor area) : ≤13.3 m³ or ≤11.1 tons - 2 credits: for an amount of waste generated per 100m² (gross internal floor area) : ≤7.5 m³ or ≤6.5 tons - 3 credits: for an amount of waste generated per 100m² (gross internal floor area) : ≤3.4 m³ or ≤3.2 tons - exemplary level : for an amount of waste generated per 100m² (gross internal floor area): ≤1.6 m³ or ≤1.9 tons <p>Where existing buildings on the site will be demolished a pre-demolition audit of any existing buildings, structures or hard surfaces is completed to determine if, in the case of demolition, refurbishment/reuse is feasible and, if not, to maximise the recovery of material from demolition for subsequent high-grade/value applications. The audit must be referenced in the SWMP and cover:</p> <ul style="list-style-type: none"> - Identification of the key refurbishment/demolition materials. - Potential applications and any related issues for the reuse and recycling of the key refurbishment and demolition materials 																		
Diversion of resources from landfill	1 credit	<p>The following percentages of non-hazardous construction and demolition waste (where applicable) generated by the project have been diverted from landfill:</p> <table border="1"> <thead> <tr> <th>BREEAM credits</th> <th>Type of waste</th> <th>Volume</th> <th>Tonnage</th> </tr> </thead> <tbody> <tr> <td rowspan="2">One credit</td> <td>Non demolition</td> <td>70%</td> <td>80%</td> </tr> <tr> <td>Demolition</td> <td>80%</td> <td>90%</td> </tr> <tr> <td rowspan="2">Exemplary level</td> <td>Non demolition</td> <td>85%</td> <td>90%</td> </tr> <tr> <td>Demolition</td> <td>85%</td> <td>95%</td> </tr> </tbody> </table> <p>Waste materials will be sorted into separate key waste groups (according to the waste streams generated by the scope of the works) either onsite or offsite through a licensed contractor for recovery.</p>	BREEAM credits	Type of waste	Volume	Tonnage	One credit	Non demolition	70%	80%	Demolition	80%	90%	Exemplary level	Non demolition	85%	90%	Demolition	85%	95%
BREEAM credits	Type of waste	Volume	Tonnage																	
One credit	Non demolition	70%	80%																	
	Demolition	80%	90%																	
Exemplary level	Non demolition	85%	90%																	
	Demolition	85%	95%																	

SUSTAINABLE REFURBISHMENT OF SCHOOL BUILDINGS

4. REDUCE WASTE PRODUCTION



4.4.2. WST 02 - Recycled aggregates

This issue aims to recognise and encourage the use of recycled and secondary aggregates, thereby reducing the demand for virgin material and optimising material efficiency in construction. This issue is **not mandatory** to achieve a minimum standard .

Criteria	Number of credits	Explanation																											
Recycled aggregates	1 credit	<p>The total amount of recycled and/or secondary aggregate specified is greater than 25% (by weight or volume) of the total high-grade aggregate specified for the development.</p> <p>To contribute to the total amount, the percentage of high-grade aggregate specified per application (where present) that is recycled and/or secondary aggregate, must meet the following minimum levels (by weight or volume):</p> <table border="1"> <thead> <tr> <th>Application</th> <th>Min. % One credit</th> <th>Min. % Exemplary performance</th> </tr> </thead> <tbody> <tr> <td>Structural frame</td> <td>25%</td> <td>50%</td> </tr> <tr> <td>Floor slabs including ground floor slabs</td> <td>25%</td> <td>50%</td> </tr> <tr> <td>Bitumen or hydraulically bound base, binder, and surface courses for paved areas and roads</td> <td>50%</td> <td>75%</td> </tr> <tr> <td>Concrete road surfaces</td> <td>25%</td> <td>50%</td> </tr> <tr> <td>Pipe bedding</td> <td>50%</td> <td>100%</td> </tr> <tr> <td>Building foundations</td> <td>25%</td> <td>50%</td> </tr> <tr> <td>Granular fill and capping (see Compliance notes)</td> <td>75%</td> <td>100%</td> </tr> <tr> <td>Gravel landscaping</td> <td>100%</td> <td>100%</td> </tr> </tbody> </table> <p>The aggregates are EITHER:</p> <ul style="list-style-type: none"> - Obtained on site - Obtained from waste processing site(s) within a 30km radius of the site; the source will be principally from construction, demolition and excavation waste (CD&E) – this includes road plannings - Secondary aggregates obtained from a non-construction post-consumer or post-industrial by-product source (Application	Min. % One credit	Min. % Exemplary performance	Structural frame	25%	50%	Floor slabs including ground floor slabs	25%	50%	Bitumen or hydraulically bound base, binder, and surface courses for paved areas and roads	50%	75%	Concrete road surfaces	25%	50%	Pipe bedding	50%	100%	Building foundations	25%	50%	Granular fill and capping (see Compliance notes)	75%	100%	Gravel landscaping	100%	100%
Application	Min. % One credit	Min. % Exemplary performance																											
Structural frame	25%	50%																											
Floor slabs including ground floor slabs	25%	50%																											
Bitumen or hydraulically bound base, binder, and surface courses for paved areas and roads	50%	75%																											
Concrete road surfaces	25%	50%																											
Pipe bedding	50%	100%																											
Building foundations	25%	50%																											
Granular fill and capping (see Compliance notes)	75%	100%																											
Gravel landscaping	100%	100%																											

4.4.3. WST 03 - Operational waste

This issue aims to recognise and encourage the provision of dedicated storage facilities for a building's operational- related recyclable waste streams, so that this waste is diverted from landfill or incineration. This issue is **mandatory** to achieve a minimum standard .

SUSTAINABLE REFURBISHMENT OF SCHOOL BUILDINGS

4. REDUCE WASTE PRODUCTION



Criteria	Number of credits	Explanation
Operational waste	1 credit	<p>There is dedicated space(s) to cater for the segregation and storage of operational recyclable waste volumes generated by the assessed building/unit, its occupant(s) and activities. The dedicated space(s) must be:</p> <ul style="list-style-type: none"> - Clearly labelled, to assist with segregation, storage and collection of the recyclable waste streams - Accessible to building occupants / facilities operators for the deposit of materials and collections by waste management contractors - Of a capacity appropriate to the building type, size, number of units (if relevant) and predicted volumes of waste that will arise from daily/weekly operational activities and occupancy rates. <p>Where the consistent generation in volume of the appropriate operational waste streams is likely to exist, e.g. large amounts of packaging or compostable waste generated by the building's use and operation, the following facilities are provided as part of its waste management strategy:</p> <ul style="list-style-type: none"> - Static waste compactor(s) or baler(s); situated in a service area or dedicated waste management space. - Vessel(s) for composting suitable organic waste resulting from the building's daily operation and use OR adequate space(s) for storing segregated food waste and compostable organic material prior to collection and delivery to an alternative composting facility. - Where organic waste is to be stored/composted on site, a water outlet is provided adjacent to or within the facility for cleaning and hygiene purposes. <p>Especially for school buildings: there is a school recycling policy and an outline of the procedures that are in operation or that will be in place when the building is complete. As a minimum, the policy should cover:</p> <ul style="list-style-type: none"> - Paper and magazines, cardboard, plastics, metals, printer & toner cartridges. - Where composting facilities are provided, the policy must also cover the collection of the compost unless the compost can be used on site.

SUSTAINABLE REFURBISHMENT OF SCHOOL BUILDINGS REFERENCES





1. Books and publications

1.1. Sustainable architecture (construction and renovation)

- A.LIEBARD, A. DEHERDE, «**Traité d'Architecture et d'Urbanisme Bioclimatique** », Editions Observ'ER, 2005, Paris, France
- Institut Bruxellois pour la Gestion de l'Environnement (IBGE), « **Guide pour la construction et la rénovation de petits bâtiments** », éditions IBGE, 2009, Bruxelles, Belgique
- Ademe, « **La qualité environnementale des Bâtiments, manuel à l'usage de la maîtrise d'ouvrage et des acteurs du bâtiment** », Ademe éditions, 2002, Paris, France
- S.NIBEL, D. de VALICOURT, « **Programmer, concevoir, réaliser et exploiter un bâtiment durable, Mettre en œuvre un système de management d'opération : mode d'emploi** », Guide Bâtir le développement durable, Centre Scientifique et Technique du Bâtiment (CSTB), décembre 2012
- M.MAZALTO, «**Architecture scolaire et réussite éducative**», éditions Fabert, Paris, 2007
- «**Naar een inspirerende leeromgeving, instrument voor duurzame scholenbouw**», publication of GO!Onderwijs van de Vlaamse Gemeenschap and Agentschap voor Infrastructuur in het Onderwijs (AGION), 2010

1.2. Comfort and quality of life

- Drs S.et P. DEOUX, « **Le Guide de l'Habitat sain, les effets sur la santé de chaque élément du bâtiment** », éditions Medieco, 2ème édition, Andorre, 2004,
- S. DEOUX, «**Bâtir pour la Santé des Enfants**», éditions Medieco, Andorre, 2010
- DEOUX, COEUDEVEZ, «**Bâtiments, Santé, le tour des labels: ajouter l'humain aux performances environnementales et énergétiques**», éditions MEDIECO, Andorra, 2011
- A.ROULET, «**Santé et qualité de l'environnement intérieur dans les bâtiments**» Presses Polytechniques et universitaires romandes, Espagne, 2004
- **Recenser, prévenir et limiter les risques sanitaires environnementaux dans les bâtiments accueillant des enfants**, Guide à l'usage des collectivités territoriales, Ministère de l'Ecologie, du développement et de l'aménagement durables, downloadable from the website www.education.gouv.fr
- Francesca R.D'Ambrosio Alfano, «**Indoor Environment and Energy Efficiency in Schools, part 1 Principles**» Guidebook n°12, Federation of European Heating, Ventilation and Air-conditioning Associations REHVA, Brussels,
- K. DE SCHRIJVER, G. TILBORGHES, D. WILDEMEERSCH «**Wonen and gezondheid**», Ministerie van de Vlaamse Gemeenschap, Administratie Gezondheidszorg, Afdeling Preventieve en Sociale Gezondheidszorg, 2003, Bruxelles, Belgique
- **WHO Guidelines for Indoor Air Quality, Selected pollutants**, report of WHO European Centre for Environment and Health, Bonn Office,2010, downloadable from the website <http://www.euro.who.int/fr/what-we-publish/abstracts/who-guidelines-for-indoor-air-quality-selected-pollutants>
- **WHO guidelines for indoor air quality : dampness and mould**,report of WHO European Centre for Environment and Health, Bonn Office,2010, downloadable from the website <http://www.euro.who.int/fr/what-we-publish/abstracts/who-guidelines-for-indoor-air-quality-selected-pollutants>
- AFSSE (agence française de sécurité sanitaire environnementale), « **Impacts sanitaires du bruit – Etat des lieux, indicateurs bruit-santé** », novembre 2004, downloadable from the website www.sante.gouv.fr
- Ch. SIMONIN-ADAM, «**Acoustique et réhabilitation, améliorer le confort acoustique dans l'habitat existant**», éditions Eyrolles, 3ème tirage, 2006, Paris, France
- JL. BEAUMIER, «**L'isolation phonique écologique, matériaux et mise en œuvre**», éditions Terre Vivante, 2006, Mens, France
- «**Concilier efficacité énergétique et acoustique dans le bâtiment**» Guide du CSTB, octobre 2010
- F.SIMON, JM HAUGLUSTAINE, «**La conception globale de l'enveloppe et l'énergie, guide pratique pour les architectes**», Ministère de la Région Wallonne, 2006, Namur, Belgique
- «**Energiezorg in scholen**», , publication of Vlaamse overheid, Vlaams Ministerie van Onderwijs en Vorming, Departement Onderwijs en Vorming Stafdienst
- F.SIMON, JM HAUGLUSTAINE, «**La rénovation et l'énergie, guide pratique pour les architectes**», Ministère de la Région Wallonne, 2006, Namur, Belgique

SUSTAINABLE REFURBISHMENT OF SCHOOL BUILDINGS

REFERENCES



- F.SIMON, JM HAUGLUSTAINE, «**La fenêtre et la gestion de l'énergie, guide pratique pour les architectes**», Ministère de la Région Wallonne, 2002, Namur, Belgique
- B. PIDERIT, «**Daylighting design strategies for visual comfort in Chilean classrooms**», PhD Thesis, juillet 2011, University Catholic of Louvain la Neuve
- «**Isolatie en ventilatie in scholen**» publication of Vlaamse overheid, Vlaams Ministerie van Onderwijs en Vorming, Departement Onderwijs en Vorming Stafdienst
- «**Designing Quality Learning Spaces: Ventilation & Indoor Air Quality**», Developed by BRANZ Ltd for the Ministry of Education, downloadable from the website www.minedu.govt.nz
- «**Designing Quality Learning Spaces: Heating & Insulation**», Developed by BRANZ Ltd for the Ministry of Education, downloadable from the website www.minedu.govt.nz
- A.DEHERDE, S. REITER, «**L'éclairage naturel des bâtiments**», Ministère de la Région Wallonne, 2001, Namur, Belgique
- **Advanced Energy Design Guide for K-12 School Buildings, Achieving 30% Energy Savings, Toward a Net Zero Energy Building**, ASHRAE Design Guide, ASHRAE, 2008
- R. JOBERT, «**Perméabilité à l'air de l'enveloppe** », Guide Bâtir le développement durable, Centre Scientifique et Technique du Bâtiment (CSTB), septembre 2012
- S. FARKH, «**Les ponts thermiques dans le bâtiment** », Guide Bâtir le développement durable, Centre Scientifique et Technique du Bâtiment (CSTB), septembre 2009
- LABERGE, «**Mieux vivre ensemble dans la cour d'école**», Montmagny, Direction de la santé publique, de la planification et de l'évaluation, Régie régionale de la santé et des services sociaux de la Chaudière-Appalaches, 1999, Canada
- «**Vergroening van de schoolomgeving, Technische handleiding voor een groene school**», publication of WWF, downloadable from the website www.wwf.be
- «**Plans de déplacements scolaires**», Guide à la réalisation, Bruxelles Mobilité, Direction Stratégie, avec les a.s.b.l. GREEN et COREN

1.3. Services and energy efficiency

- «**Conception énergétique d'un bâtiment tertiaire, concevoir et rénover un bâtiment tertiaire**», Les Cahiers de l'Energie, Région Wallonne DGOA, juin 2004
- «**School Verwarming**», publication of Vlaamse overheid, Vlaams Ministerie van Onderwijs en Vorming, Departement Onderwijs en Vorming Stafdienst
- «**School Verlichting**», publication of Vlaamse overheid, Vlaams Ministerie van Onderwijs en Vorming, Departement Onderwijs en Vorming Stafdienst
- «**Code de Bonne Pratique en Eclairage Intérieur**, Document de référence en complément à la norme NBN EN 12464-1», Institut Belge de l'Eclairage
- «**The WaY TowarDS YouR CoOL SchOOL, A Guideline To High Performance School Renovations In Europe**», schoolventcool brochure, downloadable from the website <http://www.schoolventcool.eu>
- «**Ventilation performante dans les écoles, guide à la conception**», Centre technique des industries aérauliques et thermiques CETIAT, downloadable from the website www.cetiat.fr
- «**Guide pratique sur la modulation des systèmes de ventilation**», Centre technique des industries aérauliques et thermiques CETIAT, downloadable from the website www.cetiat.fr
- A. FILLOUX, «**Intégrer les énergies renouvelables, Comment choisir, intégrer et exploiter les systèmes utilisant les énergies renouvelables?**», Guide Bâtir le développement durable, Centre Scientifique et Technique du Bâtiment (CSTB), août 2008
- F.ANTONY, Ch. DURSCHNER, KH. REMMERS, «**Le Photovoltaïque pour tous, conception et réalisation d'installations**», éditions Observ'ER en association avec Solarpraxis AG, 2006, Paris, France
- F.A. PEUSER, KH REMMERS, M. SCHNAUSS, «**Installations solaires thermiques, conception et mise en oeuvre**», éditions Observ'ER en association avec Solarpraxis AG, 2005, Paris, France
- B.BERANGER, «**Les pompes à chaleur**» 2ème édition, éditions Eyrolles, 2008, Paris, France

1.4. Water and natural resources

- M.VAN PETEGHEM, L.DE BACKER, «**Water wegwijzer voor architecten, een Handleiding voor duurzaam watergebruik in en om de particuliere woning**» Vlaamse Milieumaatschappij, 2000, Belgique

SUSTAINABLE REFURBISHMENT OF SCHOOL BUILDINGS

REFERENCES



- B.DE COUVELLO, «**La gestion durable de l'eau**», Guide Bâtir le développement durable, Centre Scientifique et Technique du Bâtiment (CSTB), janvier 2010
- CAGT, «**Guide de gestion des eaux pluviales et de ruissellement**», Communauté d'Agglomération du Grand Toulouse, Service Assainissement, 2006, Toulouse, France
- S. CABRIT-LECLERC, «**Fosse septique, roseaux, bambous? Traiter écologiquement ses eaux usées**», éditions Terre Vivante, 2008, Mens, France
- KUR, «**L'habitat écologique, quels matériaux choisir ?**», Terre Vivante, Mens, 2005
- HEGGER, AUCH-SCHWELK, FUCHS, ROSENKRANZ, «**Construire, Atlas des matériaux**», éditions DETAIL, Presses Polytechniques et Universitaires Romandes, Lausanne, 2009
- **Passivhaus-Bauteilkatalog, Details for Passive Houses: Ökologisch bewertete Konstruktionen, A Catalogue of Ecologically Rated Constructions**, publication de l'Österreichisches Institut für Baubiologie und Bauökologie, éditions Springer-Verlag en 2008
- MENGONI JC., MENGONI M., «**Matériaux écologiques d'intérieur, aménagement, finitions, décorations**», Terre Vivante, Mens, 2009
- «**Leitfaden für nachhaltiges Bauen und Renovieren**», Centre de Ressources des Technologies pour l'Environnement(CRTE), Luxembourg, 2008
- S.TRACHTE, «**Matériau, matière d'Architecture Soutenable, Choix responsable des matériaux de construction, vers une conception globale de l'architecture soutenable**» Thesis submitted in June 2012, LOCI, Catholic University of Louvain la Neuve
- S. TRACHTE, A. DE HERDE, «**Choix des matériaux - Ecobilan de parois**», Publication developed under the direction of André De Herde for the Public Service of Wallonie - Department of Energy, from 2008 to 2010 For download : <http://wallonie.energie.be>

1.5. Waste

- The European Environment, State and outlook 2010, Material, resource and waste, EEA publication, available on the website www.eea.europa.eu/.../europe/material-resources
- S.TRACHTE, «**Gestion des déchets de chantier, opportunité pour la Région de Bruxelles-Capitale**» Master thesis, september 2003, Université Catholique de Louvain la Neuve, Ecole Polytechnique de Lausanne
- S.BREELS, «**La gestion des déchets dans le secteur de la construction : enjeux de la conception architecturale, Proposition d'étude pour la réduction de la production des déchets en phase de rénovation**», Master thesis, Université Catholique de Louvain la Neuve, septembre 2005
- HUYGEN, «**La poubelle et l'architecte, vers le réemploi des matériaux**», L'impensé chez ACTES SUD, 2008
- **Guide de gestion des déchets de construction et de démolition**, version décembre 2000 édité par l'IBGE (Institut bruxellois pour la Gestion de l'Environnement), éditeur responsable: JP Hannequart, Bruxelles, 2000

2. Websites

2.1. General websites for sustainable construction and renovation

- Energie + - Conception et rénovation de Bâtiments Tertiaires : www.energieplus-lesite.be
- Brussels Environment : <http://www.ibgebim.be>
- Agence de l'Environnement et de la Maîtrise de l'Energie (ADEME) : <http://www2.ademe.fr>
- Centre scientifique et technique de la construction (CSTC) <http://www.cstc.be>
- Centre scientifique et technique du bâtiment (CSTB) : <http://www.cstb.fr>
- Centre techniques des matériaux naturels de construction: <http://www.ctmnc.fr>
- Organisme mondial de la santé (OMS) : <http://www.who.int>
- Resource Center for Environmental Technologies (CRTE - Tudor): <http://www.crte.lu>
- Vlaams Instituut voor bio-ecologisch bouwen en wonen (VIBE) : <http://www.vibe.be>
- Vlaamse Instelling voor Technologisch Onderzoek (VITO): <http://www.vito.be>

2.2. Services and energy efficiency

- Energie + - Conception et rénovation de Bâtiments Tertiaires : www.energieplus-lesite.be

SUSTAINABLE REFURBISHMENT OF SCHOOL BUILDINGS

REFERENCES



- Brussels Environment : <http://www.ibgebim.be>
- Energy Portal in Wallonia: energie.wallonie.be
- AIE SHC PROGRAM task 40 «Net Zero Energy Solar Buildings» : <http://task40.iea-shc.org>
- AIE SHC PROGRAM task 50 «Advanced Lighting Solutions for Retrofitting Buildings» : <http://task50.iea-shc.org>

2.3. Environmental assessment methods and environmental certifications

- BREEAM (BRE Environmental Assessment Method) - <http://www.breeam.org>
- LEED (Leadership Energy Environment Design) - <http://www.usgbc.org/leed>
- DGNB (German Sustainable Building Certificate) - <http://www.dgnb.de>
- TOTAL QUALITY BUILDING (Austrian Sustainable Building Council) - https://www.oegnb.net/zertifizierte_projekte.htm
- GREENSTAR (Green Building Council of Australia)- www.gbca.org.au
- VALIDEO - www.valideo.org

2.4. Environmental labels

- Ecolabel européen: <http://www.ecolabel.be>
- Label Natureplus : <http://www.natureplus.org> • Label NF Environnement: <http://www.marque-nf.com>
- Label Der Blaue Engel : <http://www.blauer-engel.de>
- Label Milieukeur: <http://www.milieukeur.nl>
- Label Nordic Swan: <http://www.svanen.nu/eng>
- Label ÖkoPlus: <http://www.oekoplus.de>
- Label FSC (Forest Stewardship Council): <http://www.fsc.org>
- Label PEFC (Program for the Endorsement of Forest Certification Schemes): <http://www.pefc.org>
- Label GUT: <http://www.gut-ev.de>
- Infolabel - Labels Guide des labels for a responsible consumption: <http://www.infolabel.be>

2.5. Environmental assessment

- Database ECOINVENT (Swiss Centre for Life Cycle Inventories): <http://www.ecoinvent.ch>
- Classification NIBE (Nederland Instituut voor Biologische en Ecologie): <http://www.nibe.org>
- Database KBOB (Koordinationskonferenz der Bau- und Liegenschaftsorgane der Offentlichen Bauherren): <http://www.bbl.admin.ch/kbob>
- Database ECOSOFT: <http://www.ibo.at/de/oekokennzahlen.htm>
- Tool Ecobau (Durabilité et construction publique): <http://www.eco-bau.ch>
- Software ECO-BAT: <http://www.ecobat.ch>
- Catalogue d'éléments de construction : <http://www.catalogueconstruction.ch>