

# Design guidelines



IEA SHC TASK 65 | Solar Cooling for the Sunbelt Regions

# Design guidelines

**This is a report from SHC Task 65:  
Solar Cooling for the Sunbelt Regions  
and work performed in  
Subtask B: Demonstration**

**Authors: Puneet Saini (Absolicon) & Wolfgang Weiss (ergSol)**

**Contributors: Ahmed Hamza H. Ali (Assuit University), Uli Jakob (JER),  
Christoffer Larsson (Dalarna University), Michael Strobel (UIBK / JER),  
Miriam Martínez (Sole), Mohammad Ghasemi (Dalarna University),  
Nayrana Daborer-Prado (FHOÖ), Pietro Finocchiaro (Solarinvent), Gaurav  
Patel (GERMI), Hannes Poier (SOLID SES) & Tamer Abdel Rehim (NVEC)**

**Date: 13 September 2023**

**Report: D-B2, DOI: [10.18777/ieashc-task65-2023-0006](https://doi.org/10.18777/ieashc-task65-2023-0006)**

## Solar Heating & Cooling Technology Collaboration Programme (IEA SHC)

The Solar Heating and Cooling Technology Collaboration Programme was founded in 1977 as one of the first multilateral technology initiatives ("Implementing Agreements") of the International Energy Agency.

**Our mission** is *"Through multi-disciplinary international collaborative research and knowledge exchange, as well as market and policy recommendations, the IEA SHC will work to increase the deployment rate of solar heating and cooling systems by breaking down the technical and non-technical barriers."*

**IEA SHC** members carry out cooperative research, development, demonstrations, and exchanges of information through Tasks (projects) on solar heating and cooling components and systems and their application to advance the deployment and research and development activities in the field of solar heating and cooling.

**Our focus areas**, with the associated Tasks in parenthesis, include:

- Solar Space Heating and Water Heating (Tasks 14, 19, 26, 44, 54, 69)
- Solar Cooling (Tasks 25, 38, 48, 53, 65)
- Solar Heat for Industrial and Agricultural Processes (Tasks 29, 33, 49, 62, 64)
- Solar District Heating (Tasks 7, 45, 55, 68)
- Solar Buildings/Architecture/Urban Planning (Tasks 8, 11, 12, 13, 20, 22, 23, 28, 37, 40, 41, 47, 51, 52, 56, 59, 63, 66)
- Solar Thermal & PV (Tasks 16, 35, 60)
- Daylighting/Lighting (Tasks 21, 31, 50, 61, 70)
- Materials/Components for Solar Heating and Cooling (Tasks 2, 3, 6, 10, 18, 27, 39)
- Standards, Certification, and Test Methods (Tasks 14, 24, 34, 43, 57)
- Resource Assessment (Tasks 1, 4, 5, 9, 17, 36, 46, 71)
- Storage of Solar Heat (Tasks 7, 32, 42, 58, 67)

In addition to our Task work, other activities of the IEA SHC include our:

- SHC Solar Academy
- *Solar Heat Worldwide*, annual statistics report
- SHC International Conference

### Our members

|                     |                                    |                |
|---------------------|------------------------------------|----------------|
| Australia           | European Copper Institute          | SICREEE        |
| Austria             | France                             | Slovakia       |
| Belgium             | Germany                            | South Africa   |
| Canada              | International Solar Energy Society | Spain          |
| CCREEE              | Italy                              | Sweden         |
| China               | Netherlands                        | Switzerland    |
| Denmark             | Norway                             | Turkey         |
| EACREEE             | Portugal                           | United Kingdom |
| ECREEE              | RCREEE                             |                |
| European Commission | SACREEE                            |                |

---

# Contents

---

- Contents..... iii**
- 1 Executive Summary ..... 1**
- 2 Scope of Activity B2 ..... 2**
- 3 Data collection case studies ..... 2**
- 4 Solar thermal cooling for high solar fractions: CO<sub>2</sub> emissions analysis for industrial cooling process 6**
  - 4.1 Introduction and aims ..... 6
  - 4.2 System description ..... 6
  - 4.3 Design parameters ..... 6
    - 4.3.1 Base case ..... 6
    - 4.3.2 Solar driven cooling case ..... 7
  - 4.4 Design objectives..... 7
  - 4.5 Area available ..... 7
  - 4.6 Meteorological data ..... 8
  - 4.7 Key components for solar system design ..... 8
  - 4.8 System simulation results ..... 9
  - 4.9 Discussion ..... 18
- 5 Comparison of Solar PV and Thermal cooling systems for industrial cooling applications ..... 19**
  - 5.1 Introduction and aims ..... 19
  - 5.2 Methodology ..... 19
  - 5.3 Limitations..... 19
  - 5.4 System description ..... 20
    - 5.4.1 Cooling loads and locations ..... 20
    - 5.4.2 Reference cooling system..... 21
    - 5.4.3 PV cooling system..... 21
    - 5.4.4 Solar thermal cooling system ..... 21
  - 5.5 Simulation models ..... 23
  - 5.6 Solar energy production output..... 24
  - 5.7 Global LCOC ..... 25
  - 5.8 Results..... 26
    - 5.8.1 Constant load ..... 26
    - 5.8.2 Weekday's load..... 27
    - 5.8.3 Daytime load ..... 28
  - 5.9 Discussion ..... 29
- 6 Combined compression-adsorption cooling system: Results from HyCool project ..... 30**
  - 6.1 Introduction and aims ..... 30
  - 6.2 HyCool hybrid chiller..... 30
  - 6.3 System performance map..... 31
  - 6.4 Validation ..... 31
  - 6.5 Energy and environmental benefits of hybrid cascade chillers..... 32

|          |   |           |
|----------|---|-----------|
| 6.6      | Discussion .....                          | 32        |
| <b>7</b> | <b>Conclusion .....</b>                   | <b>33</b> |
| <b>8</b> | <b>Annex.....</b>                         | <b>34</b> |
|          | Questionnaire for design guidelines ..... | 34        |



---

# 1 Executive Summary

---

This document is the final report for activity B2 “Design guidelines” of the IEA SHC Task 65 “Solar Cooling for the Sunbelt regions”. It presents the collection of design and system integration guidelines for solar cooling projects. For this purpose, a comprehensive questionnaire was created that goes into detail about various solar cooling components, design, sizing and other sub-systems such as heat rejection unit and cold distribution system. Data from 10 case studies are collected and presented showing the performance of solar cooling systems with varying boundary conditions. Additionally, three different case studies, each with their own scope and unique characteristics, are discussed. The summary is as follows:

- Industrial cooling offers significant opportunities for solar thermal cooling applications. Such systems can achieve a high solar fraction and thus significantly reduce CO<sub>2</sub> emissions compared to conventional electricity-powered chillers.
- The integration of solar PV with vapor compression chillers as an emerging solution for decarbonization of cooling systems. A comparative analysis considering different load and weather profiles suggests that solar PV cooling can result in lower levelized cost of cooling compared to solar thermal.
- Hybrid chillers emphasizes the potential of combining electrical and thermal chillers. Both simulation and practical results indicate a significant reduction in electricity consumption when using the topping cycle of an adsorption chiller.

In summary, these case studies highlight the transformative potential of cooling solutions. As technology advances and policies evolve, the adoption of such systems will play a critical role in shaping a greener and more energy efficient cooling future.

---

## 2 Scope of Activity B2

---

The activity focused on the collection of design and system integration guidelines for solar cooling projects. The large diffusion of solar cooling technology in market does not depend merely on the technical and economic aspects, but on the possibility of providing a systematic approach for the design and installation of the system in different climates, easily manageable even by professionals who are not expert on the specific technology. Even though, these design guidelines are well documented in deliverables of previous task (IEA SHC Task 48 & Task 53), however the current activity leverages previous knowledge to extend available guidelines to several new concepts such as a) Hybrid cooling system (including solar thermal, solar photovoltaic) b) Systems for high solar cooling fraction c) Standard modular packages for solar cooling solution. This report also presents the comparison of solar thermal systems with solar photovoltaic systems. This activity is dedicated to keep an eye on the technical research and developments and as well to collect good practice examples of existing solar driven cooling systems.

---

## 3 Data collection case studies

---

A comprehensive questionnaire is prepared which goes in detail of various solar cooling components, design, sizing and other sub-systems such as heat rejection unit and cold distribution system. The questionnaire is attached as Annex 1, was distributed to participants active in task and the responses are received. Data from 10 case studies are collected. For each component, the capacity or the procedure followed for the sizing is reported, and this aspect is addressed in activity B1, where the focus is provided to system control functions, and then all the working conditions and inputs to various components are described. For activity B2, case studies are presented which shows the performance of solar cooling system with varying boundary conditions.

The data gathered from the questionnaire has been analyzed, leading to a concise summary of each case study presented in Table 1. The table presents a comprehensive overview of various solar cooling projects across different locations. The projects vary in terms of their initiation year, with some dating back to 1999 and others still under construction as of 2021. The type of solar collectors used in these projects includes flat plate collectors, parabolic trough collectors, and concentrating Fresnel collectors, among others. The projects also differ in terms of their storage capabilities, with some having no storage and others employing advanced storage systems like Phase Change Materials (PCM) or stratified tanks.

The cooling systems employed in these projects include various types of chillers, such as adsorption, absorption (single, double, and triple effect), and hybrid systems. The demand or cooling capacity of these systems varies widely, with some designed for smaller loads of around 8 kW and others catering to demands as high as 1,759 kW. Backup systems are also mentioned for each project, providing an alternative cooling or heating source when the solar system is not operational. These backup systems include electric compression chillers, gas-fired heaters, and oil-fired boilers.

Table 1: Summary of case studies received from the task participants.

| Name-Location               | Year of commissioning | Project Type              | System specifications (collector type)  | Application                      | Consumer and cooled volume/area                            | Chiller type/cooling system                   | Backup system   |
|-----------------------------|-----------------------|---------------------------|---|----------------------------------|--|---|---|
| Photonio-Viotia (Greece)    | 1999                  | Installed                 | Flat plate collectors without storage   | Space cooling                    | Warehouse of cosmetic (air volume 130,000 m <sup>3</sup> ) | Adsorption                                    | 3 Elec. Comp. chiller*350 kW<br>2 Oil-fired boiler*1,200 kW |
| DJer GmbH-Barcelona (Spain) | 2021                  | Under construction (2021) | Concentrating Fresnel collector of 400 [m <sup>2</sup> ] with Two hot water storage tanks (@ 120°C and 85°C), and one cold storage tank | Cooling for industrial processes | food and chemical industry                                 | Hybrid (Adsorption & compression chiller)/dry | Elec. Comp. chiller for cooling & Gas-fired heater          |

|  |      |            |  |  |   |  |  |
|--|------|------------|--|--|---|--|--|
| HTSL Pvt<br>Hyderabad-<br>India              | 2013 | Installed  | PTC 820 m <sup>2</sup><br>Storage: No  | Space<br>cooling                       | Commercial<br>building<br>(Lab)<br>(14,472 m <sup>2</sup> ) | Absorption<br>chiller<br>350 kW/wet<br>cooling tower           | Elec. Comp.<br>chiller for cooling<br>(120TR)    |
| MVM Ltd.<br>Pune- India                      | 2008 | Installed  | Parabolic dish<br>concentrators<br>1,152 m <sup>2</sup> ,<br>Storage: No   | Cooling for<br>industrial<br>processes |   | Absorption-<br>Double effect<br>400 kW                         | electric<br>compression<br>chiller<br>(160TR)    |
| SEKEM Farm<br>Belbeis-<br>Egypt              |      | Installed  | Linear Fresnel<br>reflectors 448<br>m <sup>2</sup><br>Storage using<br>oil tank<br>@120°C,<br>Stratified-2<br>hours<br>coverage)                             | Power gen<br>& space<br>cooling        | Commercial<br>building<br>(42 m <sup>2</sup> )              | Absorption<br>chiller<br>12 kW/wet<br>cooling tower            | Elec. heater                                     |
| NISE,<br>Gurugram-<br>India                  | 2011 | Installed  | Parabolic<br>trough collector<br>288 m <sup>2</sup> storage<br>on cold side<br>using PCM   | Space<br>cooling                       | Commercial<br>building                                      | Absorption<br>(triple effect)<br>/wet,<br>100 kW<br>cooling    | Elec. Comp.<br>chiller for cooling               |
| Solar Cooling<br>2.0,Arizona-<br>US          | NA   | simulation | Flat plate<br>collectors 4,542<br>m <sup>2</sup> and Fresnel<br>collectors 2,710<br>m <sup>2</sup><br>Hot water<br>storage tank of<br>35 m <sup>3</sup>      | Space<br>cooling                       | Commercial<br>building<br>(600,000<br>m <sup>2</sup> )      | Absorption<br>(single/double<br>effect)<br>1,759 kW/wet        | 4 electric<br>compression<br>chiller<br>(4*1 MW) |
| Zero<br>emission<br>cooling,<br>Wels-Austria | 2019 | simulation | Photovoltaic<br>thermal<br>collectors<br>124m <sup>2</sup><br>Storage: yes<br>hot(water,<br>uniform, 90°C)   | Space<br>cooling                       | Commercial<br>building                                      | Adsorption<br>16.7 kW /wet<br>cooling                          | NO   |
| Micro-<br>brewery,<br>California-US          | 2020 | simulation | vacuum tube/<br>612 m <sup>2</sup><br>Storage:<br>hot (1*25 m <sup>3</sup> )<br>cold (1*10 m <sup>3</sup> )<br>tanks using<br>water as<br>storage media      | Cooling for<br>industrial<br>processes | Brewery   | Hybrid<br>(Adsorption&<br>compression<br>chiller)<br>70 kW/wet | gas-fired heater                                 |
| Assiut<br>University-<br>Egypt               | 2009 | Installed  | Evacuated<br>tube/ 36 m <sup>2</sup> .<br>Storage:<br>hot (1.8 m <sup>3</sup> )<br>cold (1.2 m <sup>3</sup> )<br>tanks of using<br>water as<br>storage media | Space<br>cooling                       | Commercial<br>building<br>(80 m <sup>2</sup> )              | Hybrid<br>(Adsorption&<br>compression<br>chiller)<br>8 kW /wet | gas-fired heater                                 |

The short summary of the projects is provided below:

**Photonio** is a central air conditioning initiative designed for a cosmetic company's warehouse situated in Viotia, Greece. The project employs 2,700 m<sup>2</sup> of flat plate collectors to air condition area of approximately 22,000 m<sup>2</sup>, equivalent to 130,000 m<sup>3</sup> of air. Annually, the system has a cooling demand of 2,700 MWh. This demand is met by two adsorption chillers that utilize water as the heat transfer medium. These chillers operate at a hot water temperature range of 70-75°C and produce chilled water within the range of 8-10°C. They have a rated Coefficient of Performance (COP) of 0.6. To address peak loads and ensure system reliability, the design also incorporates three electric compression chillers, each with a capacity of 350 kW. Additionally, for contingencies during overcast conditions or overnight cooling demands, two boilers, each with a capacity of 1,200 kW, have been integrated into the system.



**HyCool:** Within HyCool project (<https://hycool-project.eu/>), system is installed for an industrial process cooling project in food and chemical sector located in Barcelona- Spain, utilizing 400 m<sup>2</sup> (40 modules) of top-roof Concentrating Fresnel Collector (CFC) equipped with three thermal storages consisting of:

- Two hot storages: one PCM uniformly heated at 120°C and one stratified water at 85°C
- One cold storage; one stratified water at 6°C

Cooling demand required at two different levels of 5°C & -10°C, with chiller corresponding power consumptions equal to 12 kW and 18.5 kW, respectively. The total annual cooling demand is 57.83 MWh, provided by a hybrid adsorption and compression chiller operating with water Glycol (35% mix) as heat transfer media in adsorption cycle, activated by hot water at the temperature of 80-85°C. Electric consumption of adsorption chiller is 5.5 kW, whereas, seasonal COP of hybrid chiller could reach up to 6. Furthermore, a dry cooling tower with cooling design temperature equal to 30°C and cooling capacity of 80 kW<sub>th</sub> and parasitic consumption of 1kW<sub>el</sub> serve as heat rejection system. Moreover, a compression chiller for cooling and a gas-fired heater acting as backup system is used for covering peak loads in case of overcast and/or overnight cooling demand.

**Honeywell Technology Solutions Lab Pvt. Ltd.** is a central air conditioning project located in Hyderabad, India, utilizing 128 ground mounted Parabolic Trough Collector (Thermax Make, Solpac - P60) with total collector gross area equal to 820 m<sup>2</sup> (128\*6.41 m<sup>2</sup>) for conditioning of an area around 14,472 m<sup>2</sup> over 200 days (8 working hours/day) annually. The peak cooling load is around 351 kW, provided by a single effect Water & LiBr absorption chiller (Thermax HD20ATHU), operating with heat source temperatures of 120°C to 125°C, and providing chilled water with inlet/outlet temperature range of 16°C -12°C. Electric consumption of absorption chiller is 7.45 kW and cooling delivered by solar system is around 554 MWh/year. Furthermore, there is no storage system implemented and a wet cooling tower with cooling water temperature equal to 34°C serve as heat rejection system. Finally, an electric compression chiller (120 TR (422 kW)) as backup system for covering peak loads (over designed capacity of chiller= 350 kW) or cooling demand in case of overcasting.

**Mahindra Vehicle Manufacturers Ltd.** Implemented an industrial process cooling project located in Pune- India, utilizing 72 ground mounted Parabolic Dish Concentrators (Scheffler dish-area:16 m<sup>2</sup>) with total collector gross area equal to 1,152 m<sup>2</sup> (72\*16 m<sup>2</sup>) for cooling load over 200 days annually. The peak cooling load is around 315.9 kW, provided by a single (315kW)/double (90TR) effect Water & LiBr absorption chiller, operating with heat source temperatures of 120°C-150°C, and providing chilled water with inlet/outlet temperature range of 12°C -7°C. Furthermore, there is no storage system implemented and a wet cooling tower with cooling water temperature equal to 34°C serve as heat rejection system. Finally, an electric compression chiller (160 TR (562 kW)) as backup system for covering peak loads (over designed capacity of chiller= 315 kW) or cooling demand in case of overcasting.

**SEKEM Farm implemented** a power generating & cooling application project located in Belbeis- Egypt, utilizing 448 m<sup>2</sup> of Linear Fresnel Reflector with annual thermal output equal to 358.4 MWh/year. The heat delivered is applied for electricity production via an ORC cycle (enogia/ENO-10LT) and conditioning of an area around 42 m<sup>2</sup> over 8 month per year by a single effect Water & LiBr absorption chiller (Yazaki).

- *Power generation:* ENO-10LT with maximum 10 kW<sub>e</sub>, with thermal power input 55 kW<sub>th</sub>-160 kW<sub>th</sub>, and operating temperature of heat and cold source between 70°C -120°C and 0°C -60°C , respectively.
- *Space cooling:* The Peak cooling demand is equal to 12 kW, the absorption chiller operates with heat source temperatures of 95°C, and providing chilled water with inlet/outlet temperature range of 17°C/7°C. Furthermore, there is a heating storage of one 4 m<sup>3</sup> of stratified oil with maximum temperature of 120°C, sufficient for covering 2 hours is implemented. A wet cooling tower with cooling water temperature equal to 35°C serve as heat rejection system. Finally, an electric heater (3 kW) as backup system for cooling demand in case of overcasting is added.

**National Institute of Solar Energy** has a demonstration project utilising central air conditioning project in Gurugram-India, utilizing 48 ground mounted Parabolic Trough Collector (Thermax Make) with total collector gross area equal to 288 m<sup>2</sup> (48\*6 m<sup>2</sup>). The peak cooling load is around 100 kW, provided by a triple effect Water & LiBr absorption chiller (HT 10 AHU), operating with heat source temperatures of 210°C, and providing chilled water with outlet temperature of 7°C. Electric consumption of absorption chiller is 7 kW and cooling delivered by solar system is around 0.48 MWh/year. Furthermore, there is a PCM storage system with 30 kWh capacity implemented and a wet cooling tower serve as heat rejection system. Finally, system equipped with electric compression chiller as backup system for covering peak loads or cooling demand in case of overcasting.

Beyond the aforementioned installed projects, participants also presented simulation case studies to showcase innovative and emerging concepts in solar cooling. The details of these case studies are elaborated upon below.

**Solar Cooling 2.0** is a project simulated in Polysun, aiming to compare and optimize solar cooling systems. Initially, an existing solar cooling system, powered by flat plate collectors and a one-stage absorption chiller, was assessed. This system was then optimized by replacing its components with linear concentrating Fresnel collectors from Fresnex, designed for direct evaporation, and paired with a two-stage absorption chiller. The objective was to compare the performance and dimensioning of the two systems. Comprehensive cost analyses were conducted, encompassing investment, planning, installation, maintenance, operation, and system lifespan. The optimized system, featuring a two-stage absorption chiller, Fresnex's linear-focusing Fresnel collectors, and a direct evaporation mechanism, aims to enhance the thermal Coefficient of Performance (COP) from approximately 0.6 to around 1.2. Anticipated benefits include a reduced collector area, leading to decreased system costs, and a diminished cooling tower capacity. This translates to lower cooling water consumption, a crucial factor for desert regions. The simulation parameters are detailed as follows: The project is an air conditioning system situated in Arizona, USA, designed to condition a vast area of 600,000 m<sup>2</sup>. It employs a top-roof installation comprising 4,542 m<sup>2</sup> of Flat Plate Collectors (FPC) and 2,710 m<sup>2</sup> of Concentrating Fresnel Collectors (CFC). The system is equipped with thermal storage, holding 35 m<sup>3</sup> of water. The chiller, with a capacity of 1,759 kW, is powered by either a single Broad BDH200 or a double Thermax 2B 4M C effect Water & LiBr absorption chiller. These chillers operate at heat source temperatures of 55°C-45°C and 130°C-115°C, respectively, delivering chilled water within a temperature range of 15°C-9°C. The absorption chiller's electric consumption ranges from 15-20 kW. Additionally, a wet cooling tower, with a cooling water temperature of 37/27°C, serves as the heat rejection system. To ensure reliability, four electric compression chillers (each 1 MW) are integrated as backup, catering to peak loads or cooling demands during overcast conditions."

**Zero emission cooling** is a system concept for combined adsorption chiller with double-glazed PVT collector to generate emission-free cold. In the proposed study, The chiller operates at a driving temperature of 55°C, while the double-glazing PVT collector provides temperatures up to 80°C. The electrical output of the collector supplies parasitic consumption of chiller while excess energy would be fed into the grid. The simulation parameters are as follows: air conditioning project located in Wels-Austria, for air conditioning of a building, utilizing top-roof installation of 124 m<sup>2</sup> PVT equipped with a thermal storage consisting of 1 m<sup>3</sup> of water. The chiller capacity is 1,759 kW, provided by a single (FAHRENHEIT, eCoo10 Climatix) effect adsorption chiller, operating with heat source temperatures of 85°C-75°C, and providing chilled water with inlet/outlet temperature range of 24°C-19°C. Electric consumption of adsorption chiller is 8 kW maximum. Furthermore, a wet cooling tower serves as heat rejection system and no backup system has been provided.

**Micro-brewery**, is one simulation industrial process cooling (70 kW)/ heating (243 kW) case in brewery sector located in California- US, utilizing 612 m<sup>2</sup> of top-roof vacuum tube collector equipped with one hot (25 m<sup>3</sup>) and one cold (10 m<sup>3</sup>) of water stratified thermal storages. Cooling demand is provided by a hybrid of two adsorption and one compression chiller, adsorption chiller operates by hot water at the temperature of 90°C. Furthermore, a wet cooling tower serves as heat rejection system. Moreover, a gas-fired heater acting as backup system for covering peak loads in case of overcast and/or overnight cooling demand.

**Assiut University** has a research project including design, set up and operation of an integrated solar-operated residential cooling plant in the hot, arid area. The results compare experimentally and analytically the energy scale of solar-driven system to an electrically driven vapour compression chiller under the operating conditions of hot areas. The solar thermal driven adsorption cooling system supplies the cooling demand for an area of 80 m<sup>2</sup>. The system consists of: evacuated tube collector of 36 m<sup>2</sup> equipped with hot water storage of 1.8 m<sup>3</sup> and a cold water storage of 1.2 m<sup>3</sup>. Cooling load is supplied by an adsorption chiller with 8 kW cooling capacity. A wet cooling tower as a heat rejection system along with a backup gas water heater is implemented. Chiller operates with hot water supply temperature ranges from 60°C to 95°C.

Within the design guidelines, the most promising solar cooling applications, and the innovative concepts are detailed in case studies. A total of three case studies are chosen for detailing with following theme:

- Solar cooling for high solar fraction in industrial boundary conditions.
- Novel combined compression-adsorption cooling system
- Comparison of PV driven cooling with thermal cooling

---

## 4 Solar thermal cooling for high solar fractions: CO<sub>2</sub> emissions analysis for industrial cooling process

---

### 4.1 Introduction and aims

This case study summarizes the results from a simulation study on solar cooling solution for an industrial plant using boundary conditions from a real case study. The main application in this case is for process cooling using solar thermal solution which can reduce the final CO<sub>2</sub> emissions of the cooling processes in the plant. The focus is on techno-environmental analysis for a solar integrated system where solar thermal cooling solution with a back-up source are compared with a reference base system. The focus is on high solar fraction system, and to show the dynamics of solar thermal system for those high fractions.

The results have shown that the most optimal case fulfilling all the design boundaries consists of a solar cooling system which can fulfil up to 50 % of the cooling process demand, and the remaining 50 % is provided by the absorption chiller using back-up steam sourced internally from the industrial plant. The objective function in the analysis was set to maximum CO<sub>2</sub> savings. Overall, the simulated system results in annual CO<sub>2</sub> savings of nearly 25,000 tonnes/year, compared to base case. This would result in annual CO<sub>2</sub> emission reduction of 53 %.

### 4.2 System description

This case focuses on integrating a solar cooling solution in large scale refrigeration system for gas liquefaction. The cooling load is 35 MW, which is constant thru out the year due to the process characteristics. The heating load is not usual for residential or commercial cooling, and therefore it is interesting to see how the solar cooling system can help to reduce the demand. The cooling load can be served through 2 heat exchangers, for 2 different processes

- Heat exchanger 1: 10 MW to cool the water stream from 40°C to 22°C
- Heat exchanger 2: 25 MW to cool the stream from 40°C to 18°C

The process cooling load is constant without any temporal variation, as shown in Figure 1. The annual cooling demand for solar thermal system design is 306 GWh.



**Figure 1: Process cooling demand**

### 4.3 Design parameters

#### 4.3.1 Base case

A solar thermal system cooling system is designed for given boundary conditions. This system is compared to a base case, that is an alternative to the solar thermal cooling solution. Analysis of this base case is critical w.r.t CO<sub>2</sub> emission to ensure that the solar thermal system outperforms it. The base case consists of current system without any solar cooling system. In this case, the cooling effect is produced by the existing electrical chiller using R290 as refrigerant. The electricity needed to operate the propane chiller is derived from a inhouse power production unit driven with Gas. The specifics of the base case are shown in Table 2, based on inputs provided by the user.

Table 2: Specifics of the base case system

| Base case                             |  |
|---------------------------------------|--|
| Refrigeration source                  | Electrical chiller with R290 refrigerant |
| COP of the chiller                    | 2.5                                      |
| CO <sub>2</sub> emissions for cooling | 149 kg CO <sub>2</sub> /MWh cooling      |

### 4.3.2 Solar driven cooling case

In this configuration, the existing refrigeration unit shall be completely replaced by the absorption chiller, which will provide the cooling power converting solar radiation as the main energy source. When the solar cooling decreases its output (daily cycle) or in case of unavailability of sun (cloudy/rainy days), spilled steam (called back-up steam hereafter) from inhouse power plant will be diverted as a heat source to the Absorption chiller, thus keeping the absorption chiller operating continuously at nominal capacity. The alternative system is defined as a combination of solar thermal collector + storage tank+ backup steam + Absorption chiller, as is shown in Figure 2.

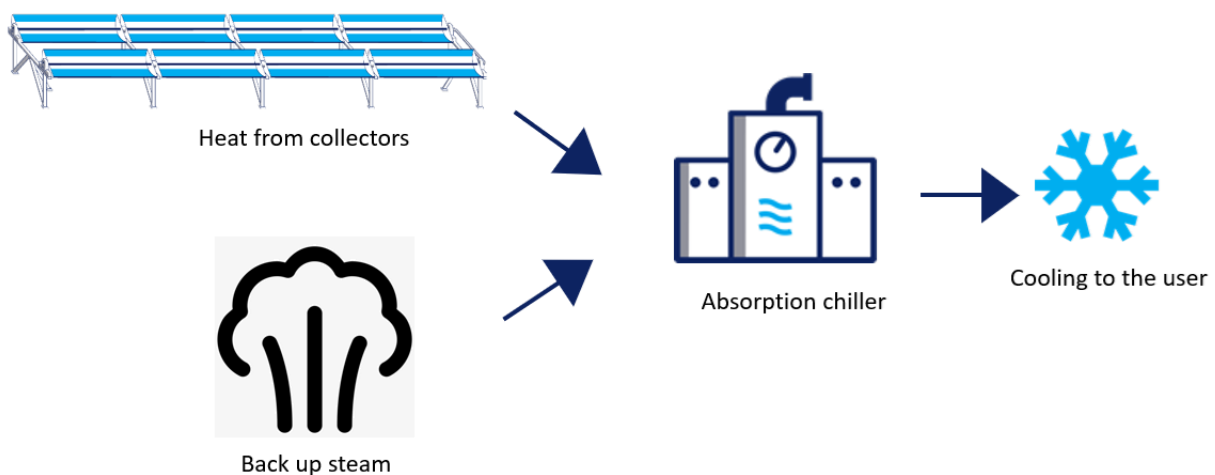


Figure 2: Various components in solar retrofitted alternative cooling system

The back-up steam is available at about 16.3 bar and 395°C. The temperature can be lowered to match the design condition of the absorption chiller. The CO<sub>2</sub> emission of back up steam is 165 kg CO<sub>2</sub>/MWh<sub>th</sub>. Assuming a thermal chiller COP of 1.35, the CO<sub>2</sub> emission for cooling from back up steam will be at 122 kg CO<sub>2</sub>/MWh<sub>c</sub>. Therefore, the CO<sub>2</sub> emission for cooling produced thru back up steam is s lower than the existing propane chiller.

## 4.4 Design objectives

In this study the focus is entirely on the CO<sub>2</sub> savings of Solar Retrofitted Alternative Cooling System (SRACS) compared to the base case. The CO<sub>2</sub> saving is set as a critical objective function for system design.

The simulations are performed to reach the maximum optimal solar fraction and CO<sub>2</sub> savings. The final configuration is decided based on the land area availability.

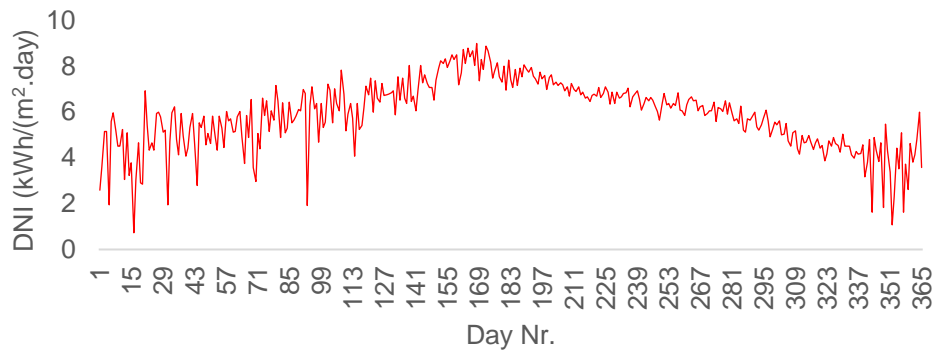
## 4.5 Area available

The plant is located in Egypt. Two areas have been identified for possible solar field location, one inside the fence and another outside the fence. A total of 34.8 ha (348,000 m<sup>2</sup>) is available at site, inside the fence as a gross surface for the development of the solar field

## 4.6 Meteorological data

The system is simulated dynamically using TRNSYS. The input to the simulator is meteorological data for the location. A statistically normal year generated by "Meteonorm" for the project location is used for simulations.

For this project, the weather file for location is derived- The annual direct normal irradiation (DNI), is the amount of direct solar irradiation received by a horizontal surface (higher the better). The DNI for the analyzed location is 2,146 kWh/m<sup>2</sup>/year. The daily variation in the DNI is shown in Figure 3.



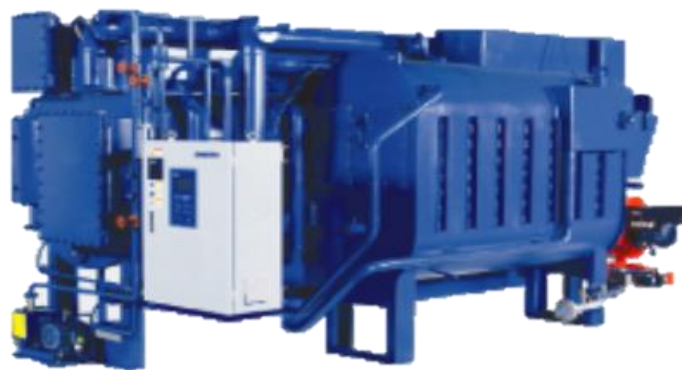
**Figure 3: Daily variation in the DNI for plant location**

## 4.7 Key components for solar system design

### Absorption chiller

There is a wide range of thermal chillers available in the market (for e.g absorption, adsorption, desiccant based cooling system etc.). The absorption is the most commonly used technology to produce cooling out of these chillers. Double effect chillers are energetically superior to single effect, thus having better cost-competitiveness. Therefore, the results in this report are restricted to Double effect chiller only.

A reference double effect absorption chiller is used for the analysis. It is a Lithium Bromide (LiBr) based pressurized hot water driven chiller. The performance data for a reference chiller is used with inlet and outlet generator temperatures of 155°C, and 150°C, respectively. The chiller has a reference COP of 1.52. The reference COP is scaled for larger chiller capacities and power consumption. The picture from the manufacturer's product catalogue is shown in Figure 4. A safety factor of 10 % in chiller COP is used for solar system design. Therefore, the COP used for system design is 1.35. Furthermore, the effect of cooling capacity at partial load conditions is also considered in the analysis.



**Figure 4: View of double effect absorption chiller (courtesy of Sakura aircon)**

### Thermal storage

A high volume of cold storage is needed in this case to reach a solar fraction as high as possible. A better fit for this case was found from a tank supplier, which can manufacture a non-pressurized tank with unit volume up to 10,000

m<sup>3</sup> (Figure 5). Multiple units can be combined together to achieve higher tank volumes. The big advantage seems to be the on-site assembly of the tank, where all the tank components can be shipped, and assembled on-site, and thus saving the large transportation volume. The tanks are well suited to cold water storage applications.

The maximum temperature in the tank is governed by the process temperature (40°C), and the minimum temperature is limited by the chiller outlet temperature (i.e 7°C). Therefore, ideally an effective temperature difference of 33 K is possible. An effective temperature difference of 25 K is considered for storage design in this considering HX pinch.



**Figure 5: Example of a large, chilled water storage tank from the manufacture**

It is also possible to use a hot water storage tank instead of cold water storage. However, The cold storage solution was preferred compared to hot storage due to the following reasons.

- As the cooling design is for a double-effect chiller, the hot storage would need a pressurized tank. However, in case of cold storage as the temperature is between 10°C to 35°C, the tank can be non-pressurized. The non-pressurized tanks are significantly cheaper than cold storage..
- The heat losses to ambient from a cold storage tank would be much smaller compared to hot storage. This is due to the lower dT (difference of storage temperature to ambient temperature) in cold storage.
- Use of storage on cold side would allow more smooth operation of chiller. Chiller can be operated during day time, and cold can be stored in the tank. In the case of hot storage, as the storage is usually installed before the chiller, then chiller operation is governed by the cooling demand, which can have significant variation and lead to poor chiller performance.

### Heat rejection system

The heat rejection system is an essential part of absorption chillers, with a function to reject the heat to the ambient. This is typically done using cooling towers. However, for this case study, an alternate cooling source as seawater is assumed to be available, and therefore no cooling tower is modelled in the analysis.

For comparison, the electricity use (and subsequent CO<sub>2</sub> emissions) of all SRACS components is considered, which includes:

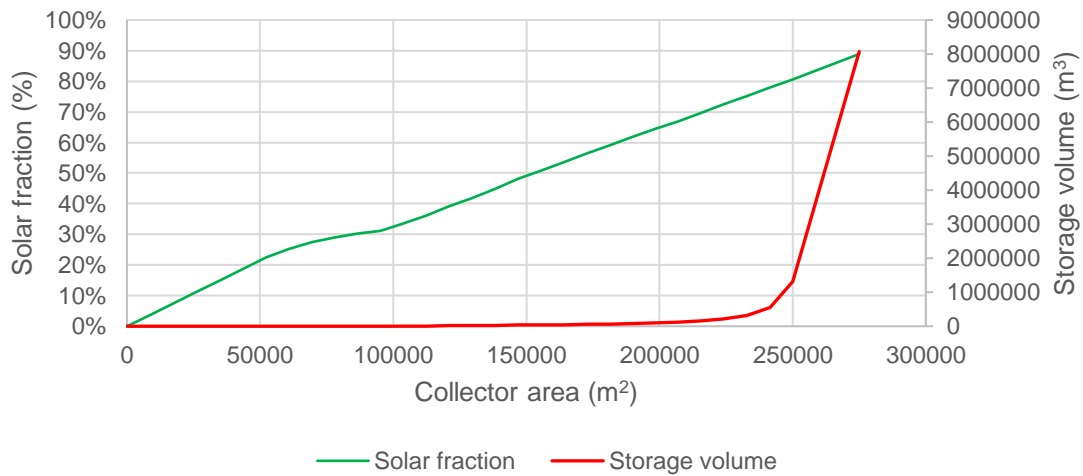
- Solar thermal collector system (Electricity use/emissions due to tracking)
- Solar central system (Electricity use/emissions due to pumping)
- Absorption chiller (Electricity use/emissions due to chiller operation)
- CO<sub>2</sub> emissions due to back-up steam

## 4.8 System simulation results

Initially, SRACS is simulated to maximize the solar fraction, and thus a reduction in CO<sub>2</sub> emissions compared to the base case. The effect of the collector area on the solar fraction and storage volume is shown in Figure 6 below. The solar fraction represents the fraction of cooling generated by the solar thermal collectors w.r.t total process demand in SRACS.



As it can be seen that to reach nearly 100 % solar fraction (thus no back up steam requirement), a collector area of 300,000 m<sup>2</sup>, and an extremely high tank volume of 18 million m<sup>3</sup> are needed. Even though such a system (at 100 % SF) will displace the maximum CO<sub>2</sub>, it is economically and practically non-feasible to have such large storage volumes due to very low energy storage density. Also important to note that without any storage the system would reach a plateau at about 30% SF. Then the increase is linear thanks to the cooling stored in the storage.

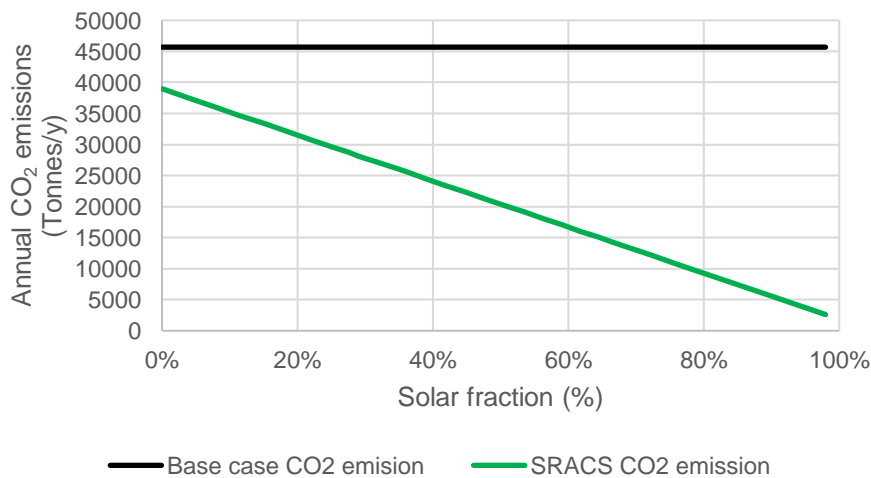


**Figure 6: Effect of collector area, and storage volume on solar fraction in SRACS.**

The CO<sub>2</sub> emissions of the alternative cooling system at various solar fraction are shown in Figure 7. The results are compared with base case emissions (i.e., no solar thermal collector). It can be seen if the absorption chiller is fed by 100 % back up steam (thus 0 % SF), the CO<sub>2</sub> emission of SRACS is lower than the base case. This is also shown in Table 3, where the CO<sub>2</sub> emission SRACS case at 0 % SF is 38,960 Tonnes/y, whereas the same for the base case is 45,683 Tonnes/y. Therefore, there is a 15 % reduction in CO<sub>2</sub> emissions by switching from propane chiller to thermal chiller powered by back up steam. This is possible thanks to the new configuration for providing 35 MW<sub>c</sub> (alternative case). It consists of:

1. Electrical chiller in the alternative case running with lower flow rate, hence consuming less power; resulting in CO<sub>2</sub> emissions savings.
2. Absorption chiller driven by back up steam, where steam is directly converted into cooling energy, while in the reference case steam is used to produce electricity to run the propane cycle. Therefore, lower conversions lead to less primary energy consumption.

Hence, the CO<sub>2</sub> emission index for cooling generated by the backup steam (122 kg CO<sub>2</sub>/MWh<sub>c</sub>) is lower than the base case (149 kg CO<sub>2</sub>/MWh<sub>c</sub>).



**Figure 7: CO<sub>2</sub> emission of base case and solar retrofitted absorption cooling system (SRACS) at various solar fractions**

Table 3: System CO<sub>2</sub> emissions

| System CO <sub>2</sub> emissions to fulfil cooling demand |                    |
|---|--------------------|
| Base case   | 45.683 Tonnes/y    |
| SRACS (0% Solar fraction)                                 | 38.960 Tonnes/year |
| SRACS (98% Solar fraction)                                | 2.613 Tonnes/year  |

In another simulation approach, the tank volume was limited to specific capacity to avoid excessively large tanks. The collector area was allowed to increase at fixed maximum tank volume. The system simulation results are shown in Figure 8. It can be seen that solar fraction up to 30 % can be achieved without any storage volume. After this, storage volume is allowed to increase with maximum value of nearly 38,000 m<sup>3</sup>. The solar fraction increases from 30 % to 50 % at this storage volume. Afterwards, if the storage volume is kept constant and the collector area is increased, then the increase in the solar fraction is very low. The maximum solar fraction value is at 57 % at a collector area of 250,000 m<sup>2</sup>, and tank volume of 38,000 m<sup>3</sup>.

The effect of limited storage volume can be seen in the increase of excess cooling as shown in Figure 9. The excess cooling is generated by solar collector, however could not be stored or utilized in the process. The increase in excess cooling is significant after the solar fraction of 50 % due to limitation on the maximum allowed tank volume.

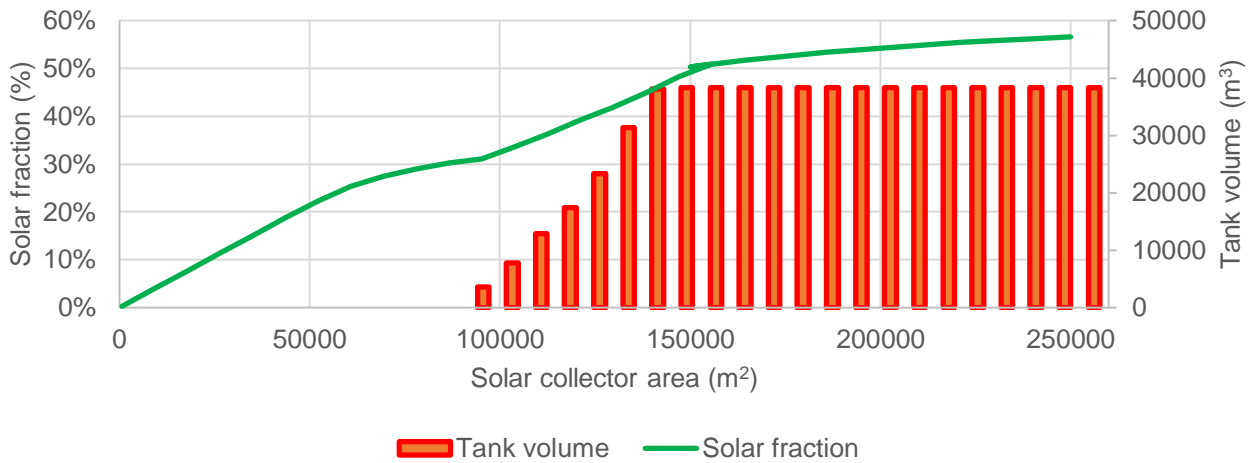


Figure 8: Effect of collector area, and storage volume on solar fraction in SRACS with max storage volume

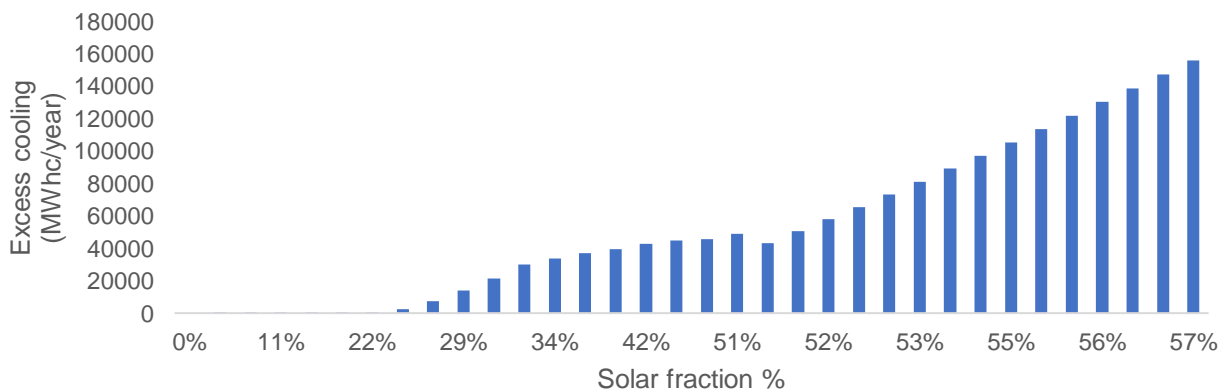


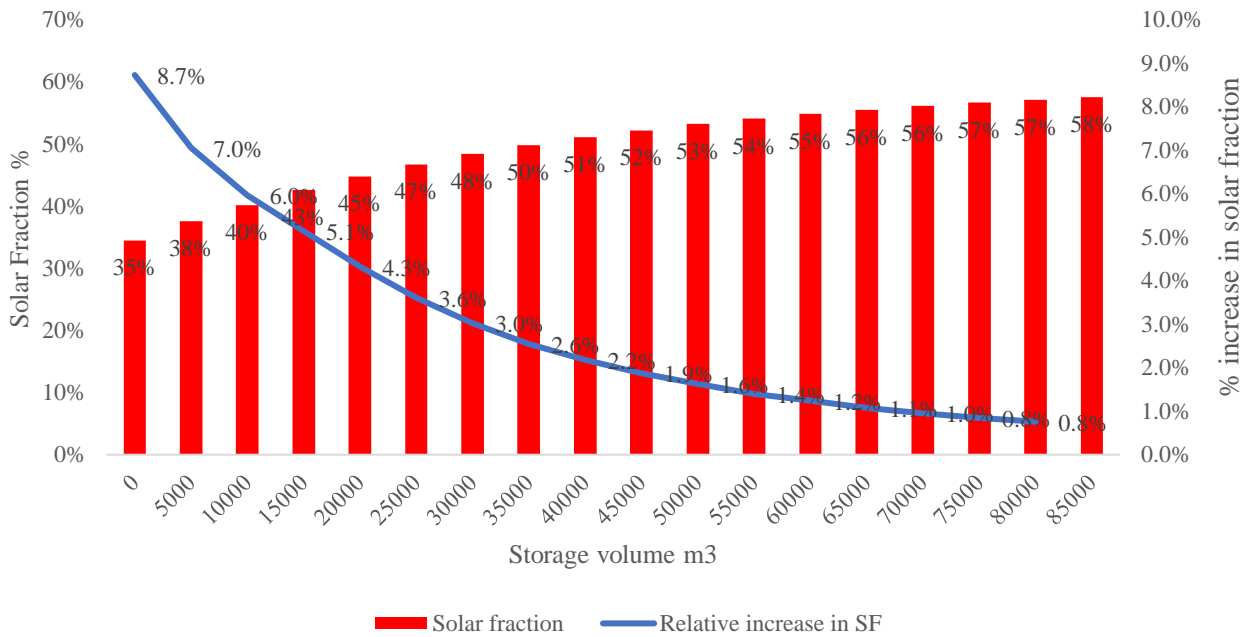
Figure 9: Variation of solar fraction with excess cooling available



**System performance for the designed case.**

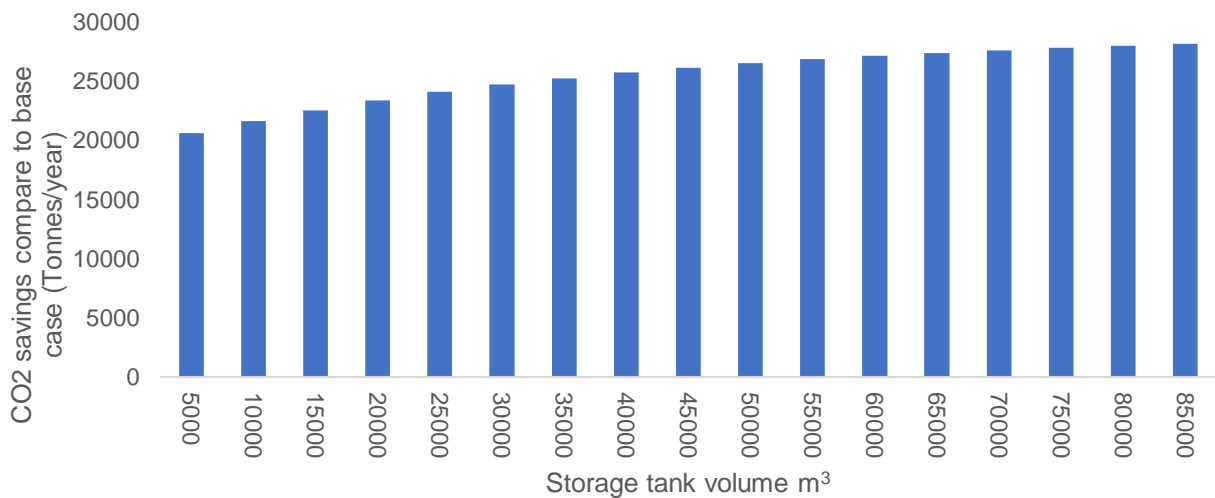
After reviewing the results in the above section, it can be inferred that given the realistic tank volume, the optimal solar field area is between 140,000 m<sup>2</sup> to 160,000 m<sup>2</sup>, with solar fraction ranging from 47 % to 52 %. These optimal collector areas fit well within the maximum land area available inside the plant fence. Therefore, the final collector area was chosen to fill the land area of 348,000 m<sup>2</sup> (i.e 153,516 m<sup>2</sup>)

A sensitivity analysis is conducted for a fixed collector area, with varying storage volume. Figure 10 shows that the relative % increase in SF is nearly 5% up to tank volume of 25,000 m<sup>3</sup>. After this, the increase in solar fraction lowers down to 1 %, finally plummeting to 0.8 %. Results indicates that the energy storage density decreases up to 5 % every 5,000 m<sup>3</sup> increase in storage volume. Looking at the results, it seems that any tank volume between 25,000 m<sup>3</sup> to 35,000 m<sup>3</sup> is optimal.

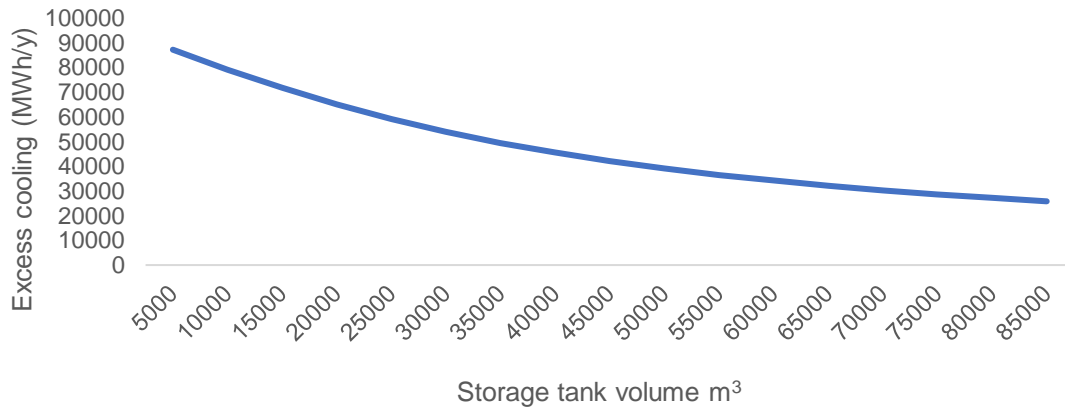


**Figure 10: Effect of storage volume on fixed collector area of 153,316 m<sup>2</sup>**

The increase in storage volume results in increasing in solar fraction, and therefore reduction in more CO<sub>2</sub> emissions compared to base case, as shown in Figure 11. As the solar fraction increases, a non-linear decrease in the excess cooling can be seen with increasing storage volumes as shown in Figure 12.



**Figure 11: Variation of CO<sub>2</sub> savings with increasing storage volume**



**Figure 12: Variation of Excess cooling with increasing storage volume**

After discussion with user, the final tank volume chosen is 35,000 m<sup>3</sup>. Considering the space needed for other system components, the final chosen collector area is 150,040 m<sup>2</sup>. The performance of the finalized configuration is shown in Table 4 below.

*Table 4: Performance data for the final selected system configuration.*

**Cooling load**

|  |                       |     |
|--|-----------------------|-----|
| <b>Annual cooling load</b>                 | GWh/year              | 306 |
| <b>Supply temperature to chiller</b>       | °C                    | 155 |
| <b>Supply pressure</b>                     | bar gauge             | 5   |
| <b>Return temperature from the chiller</b> | °C                    | 150 |
| <b>Peak cooling load</b>                   | MW                    | 35  |
| <b>Heat carrier in solar field/chiller</b> | Pressurized Hot water |     |

**Solar thermal system**

|  |                          |         |
|--|--------------------------|---------|
| <b>Solar field aperture area</b>               | m <sup>2</sup>           | 150,040 |
| <b>Nos of collectors required</b>              | Nos                      | 27,280  |
| <b>Solar field peak capacity</b>               | MW                       | 105     |
| <b>Land area required for collectors</b>       | m <sup>2</sup>           | 343,000 |
| <b>DNI</b>                                     | kWh/m <sup>2</sup> /year | 2,147   |
| <b>Nominal heat provided to the process</b>    | GWh/year                 | 112.4   |
| <b>Nominal cooling provided to the process</b> | GWh/year                 | 151.7   |
| <b>Solar cooling fraction</b>                  | %                        | 50 %    |

|   |            |       |
|---|------------|-------|
| <b>Make up water quantity needed</b>          | kg/year    | 1,000 |
| <b>Cooling requirement from back up steam</b> | GWhc/year  | 154   |
| <b>Thermal requirement from backup steam</b>  | GWhth/year | 114   |

#### Storage performance

|  |                          |        |
|--|--------------------------|--------|
| <b>Cooling stored by the tank</b>                    | GWh/year                 | 46.2   |
| <b>Storage type</b>                                  | Non-pressurized, 0 bar g |        |
| <b>Tank volume required (m<sup>3</sup>)</b>          | m <sup>3</sup>           | 35,000 |
| <b>Total storage peak capacity</b>                   | MWhc                     | 1,010  |
| <b>Energy % stored by tank</b>                       | 30%                      |        |
| <b>Nos of storage tank envisioned</b>                | 6                        |        |
| <b>Capacity of each storage tank</b>                 | m <sup>3</sup>           | 5,840  |
| <b>Dimension of each storage tank unit</b>           | (D*H)                    | 20*18  |
| <b>Maximum charging/discharging rate per storage</b> | MW                       | 9/3.5  |
| <b>Design maximum flow rate thru storage</b>         | Tonnes/h                 | 2,000  |

#### Chiller

|  |                          |            |
|--|--------------------------|------------|
| <b>Chiller type</b>                          | Double effect absorption |            |
| <b>Chiller electric power consumption</b>    | MWh/year                 | 3,985      |
| <b>Total chiller cooling capacity needed</b> | MW/TR                    | 110/31,250 |
| <b>Nos of chiller envisioned</b>             | 18                       |            |
| <b>Capacity of each chiller unit</b>         | MW                       | 6.7        |
| <b>Dimensions of each chiller unit</b>       | (L*W*H) meters           | 8*5*5      |
| <b>Operational weight of each chiller</b>    | Tonnes                   | 65         |

#### Electricity consumption

|   |          |       |
|---|----------|-------|
| <b>Electricity consumption (solar collectors)</b>       | MWh/year | 92    |
| <b>Electricity consumption (solar central)</b>          | MWh/year | 398   |
| <b>Electricity consumption (pump primary side)</b>      | MWh/year | 1,000 |
| <b>Electricity consumption (Secondary side storage)</b> | MWh/year | 340   |
| <b>Electricity consumption (Absorption chiller)</b>     | MWh/year | 3,985 |
| <b>Total electricity consumption of SRACS</b>           | MWh/year | 5,815 |

## CO<sub>2</sub> savings

|   |             |        |
|---|-------------|--------|
| <b>Base case CO<sub>2</sub> emissions</b>               | Tonnes/year | 45,683 |
| <b>CO<sub>2</sub> emissions from Auxiliary of SRACS</b> | Tonnes/year | 2,169  |
| <b>Emissions from back up steam</b>                     | Tonnes/year | 18,928 |
| <b>Total CO<sub>2</sub> emission SRACS</b>              | Tonnes/year | 21,097 |
| <b>CO<sub>2</sub> reduction compare to base case</b>    | Tonnes/year | 24,586 |
| <b>% CO<sub>2</sub> reduction compared to base case</b> | %           | 53%    |
| <b>CO<sub>2</sub> emission index</b>                    | kg/MWhc     | 14.2   |

(Auxiliary consumption / Nominal cooling provided to the process)

|  |         |      |
|--|---------|------|
| <b>CO<sub>2</sub> emission index (Auxiliary + Backup only)</b> | kg/MWhc | 68.9 |
|--|---------|------|

(Total CO<sub>2</sub> emission SRACS / Annual cooling load)

## Excess cooling

|   |       |        |
|---|-------|--------|
| <b>Excess cooling available from SARCS</b>  | MWh/y | 45,806 |
| <b>% of overall solar heat utilisation*</b> | %     | 73%    |

\*Defined as % of the overall heating generated by solar cooling that is utilised in absorption chiller for process cooling. The rest (excess) is dissipated as heat without effective use.

The chiller dimensioning is done base on the chiller capacity of 6.7 MW<sub>c</sub> (1,903 TR), therefore in total 18 chillers would be required to meet the total cooling demand. As per the manufacturer, there is possibility of having customised chiller of 20 MW<sub>c</sub> capacity.

The monthly variation in the system performance is shown in Figure 13. The solar field generates most of heat during the summer months. A major fraction of this heat is used directly in the process without going thru storage. However, due to daily and seasonal mismatches in the user load and solar irradiation availability, some heat cannot be used in the absorption chiller. This excess heat is wasted, and is represented by "capacity reserve", and is mostly available in summer, and is equivalent to 34 GWh<sub>th</sub>/year. It is advisable to find another heat/cold user (sink) to valorize this excess in order to maximize the solar plant utilization.

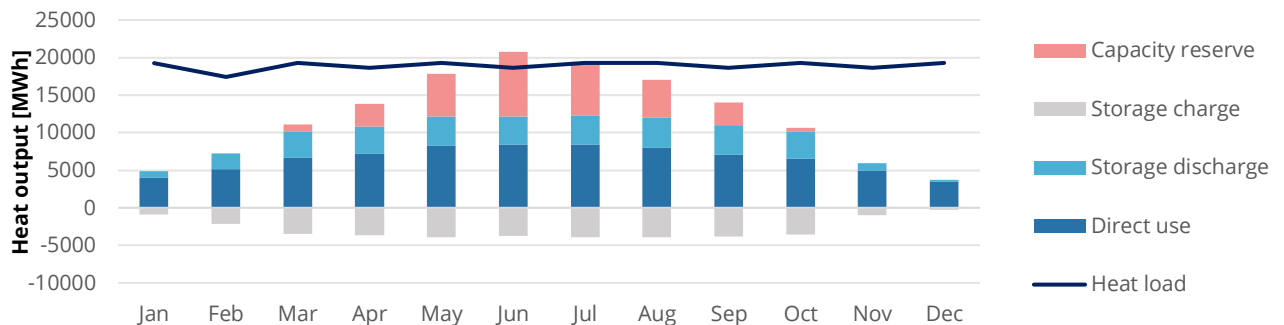
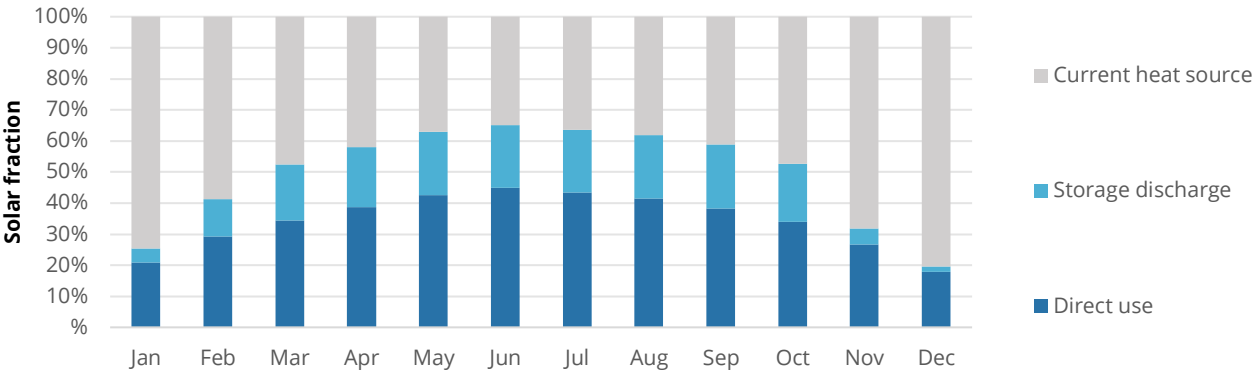


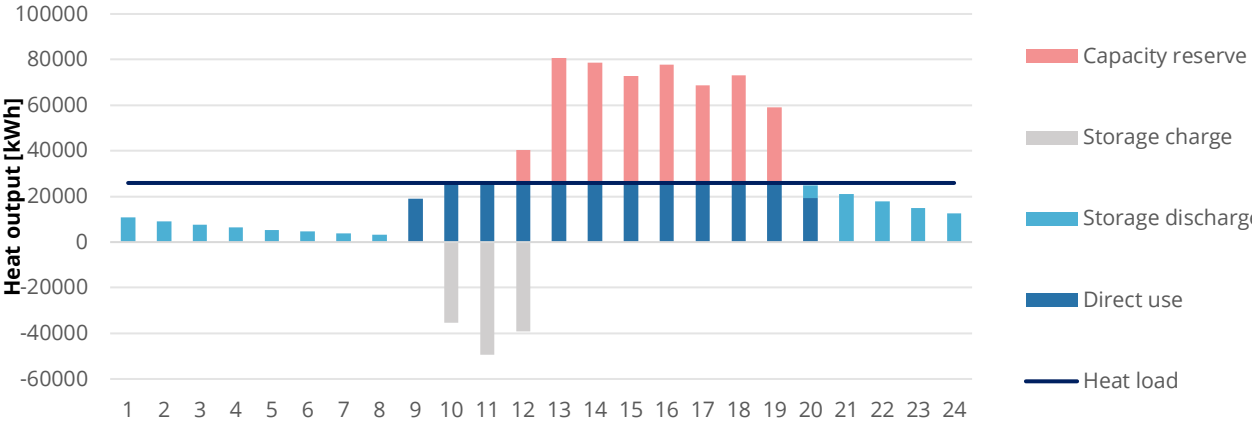
Figure 13: Monthly variation in the system performance

The variation in the monthly solar fraction is shown in Figure 14. Solar fraction refers to the percentage of total cooling load of the processes which is met by the solar system. It is clear that during the summer months, solar collectors will fulfil to 60 % of cooling demand. The annual average solar fraction of the system is 50 %.



**Figure 14: Variation of monthly solar fraction for primary user**

The variation on a daily basis can be best captured by Figure 15, which shows the system performance on the highest irradiation day. During 24-hours operation, nearly 16 hours of cooling demand is met by solar collectors with storage. The solar collector produces more than what is needed, and thus resulting in excess cooling, which is not stored. The performance on the best day is compared with "average day" and "worst day" (No DNI) in Figure 16. The variation of the excess heating not utilized is shown in Figure 17.



**Figure 15: Solar collector performance in the overall system for the highest irradiation day**

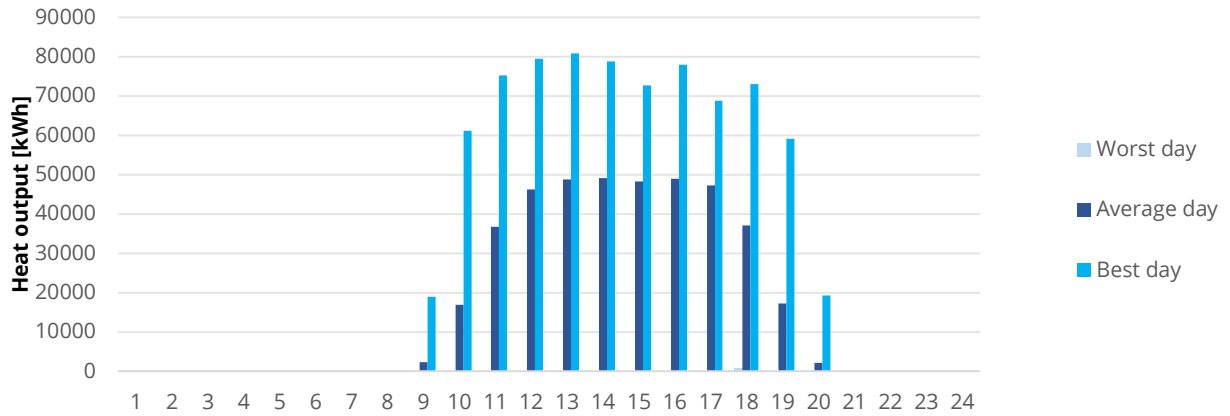


Figure 16: Solar collector performance in the overall system for average and worst DNI days

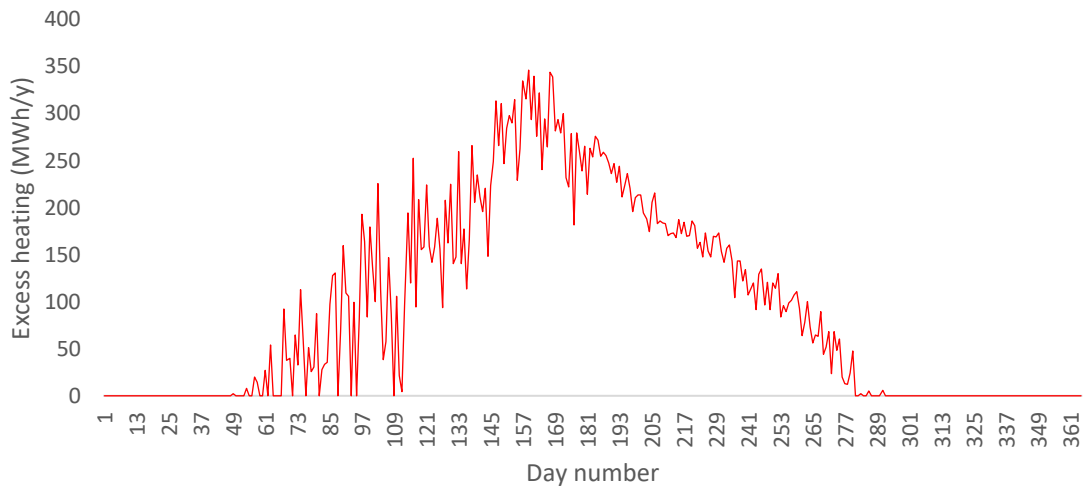


Figure 17: Hourly variation of the heating not utilized from solar field

The process flow diagram for the system is shown in Figure 18.

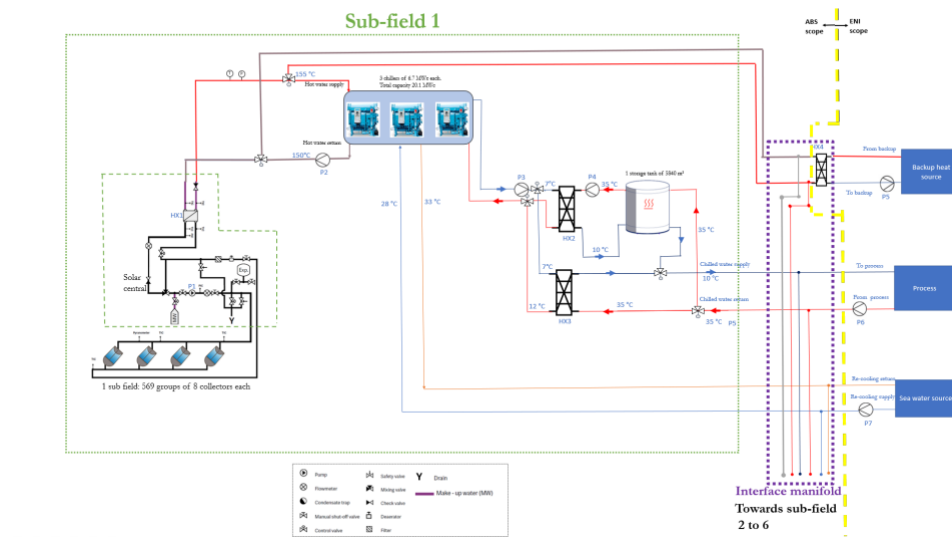


Figure 18: Process flow diagram for one sub-field in the total designed system

Overall, the whole system is divided into 6 sub-fields, with each subfield connected by main manifold. A master control room will be provided to operate each sub-field. The main specification of each sub-field is shown below.

- Collector area: 25,036 m<sup>2</sup> (569 groups of 8 collectors each)
- Storage volume: 1 tank of 5,840 m<sup>3</sup>
- Chiller: 3 chillers of 6.7 MW<sub>c</sub> each (Total 20.1 MW<sub>c</sub> per sub-field)
- Nos of heat exchanger per sub-field: 3 (Unique for hot water, thermal storage and process side).

There is an interface manifold which combines the inputs to each sub-field from Backup heat source, heat rejection circuit, and process circuit. The system is operated based on a control strategy which is defined using the following parameters

If, at any given time  $t$ ,

- $Q_{solar}$ : Cooling available directly from solar collector field
- $Q_{backup}$ : Cooling available from back up steam
- $Q_{process}$ : Cooling demand of the process
- $Q_{storage}$ : Cooling available to/from the storage
- $Q_{excess}$ : Cooling could not be stored or used in the process

On the discharge, the control is shown below in equations. The first priority is to provide  $Q_{process}$  via directly from  $Q_{solar}$ , and then  $Q_{storage}$ . If the combined cooling available from both  $Q_{solar}$ , and  $Q_{storage}$  is not sufficient, then the  $Q_{backup}$  is used.

If,  $Q_{process} > Q_{solar}$   
 And  $Q_{storage\_dis} \geq Q_{process} - Q_{solar}$   
 Then  $Q_{process} = Q_{solar} + Q_{storage\_dis}$ , until fully discharged storage.  
 Else,  $Q_{backup} = Q_{process} - Q_{solar} - Q_{storage\_dis}$

On the other hand, if the energy available from the solar field is higher than the process demand, then the process demand is met, and the storage is charged until its maximum capacity. If there is still some additional energy available from the solar field, then it is spilled. The control is shown below.

If,  $Q_{process} < Q_{solar}$   
 And storage is fully charged then  $Q_{excess} = Q_{solar} - Q_{process}$  and  $Q_{backup} = 0$   
 If storage is not fully charged  $Q_{storage\_cha} = Q_{solar} - Q_{process}$  and  $Q_{backup} = 0$

## 4.9 Discussion

The results have shown that the most optimal case fulfilling all the design boundaries consists of a solar field with a collector gross area of 150,040 m<sup>2</sup> (27,280 solar collectors of 5.5 m<sup>2</sup> each) and cold storage volume of 35,000 m<sup>3</sup> (6 tanks of 5840 m<sup>3</sup> each). The land area required by the system would be nearly 346,000 m<sup>2</sup>. The solar field coupled with a storage and double effect absorption chiller generates 151 GWh<sub>c</sub>/year, and this can fulfil up to 50 % of the cooling process demand, and rest 50 % is provided by the back-up steam sourced internally from the CCGT plant. The seasonal variation in the production and process demand results in excess heating of 46 GWh/year which could not be used in the process.

The objective function in the analysis was set to maximum CO<sub>2</sub> savings. Overall, the simulated system result in annual CO<sub>2</sub> savings of nearly 25,000 tonnes/year, compare to base case. This would result in an annual CO<sub>2</sub> emission reduction of 53 %. The annual CO<sub>2</sub> emissions of SARCS is 21,097 tonnes/year, due to emissions related to back up steam, auxiliary operations etc. Therefore, the CO<sub>2</sub> emission index of SARCS generated cooling is 68 kg CO<sub>2</sub>/MWh<sub>c</sub>, much lower than the base case index (149 kg CO<sub>2</sub>/MWh<sub>c</sub>). It is Important to notice that the back-up steam emissions constitute the largest part of emissions. Only from solar system perspective (no back up steam), the CO<sub>2</sub> emission index is 14.2kg CO<sub>2</sub>/MWh<sub>c</sub>. In a case when no solar collectors are used, and absorption chillers are fed by back up steam, then it is observed that the CO<sub>2</sub> emissions can be reduced by 15 % compare to base case. This is because the CO<sub>2</sub> emission index for cooling generated by the backup steam (122 kg CO<sub>2</sub>/MWh<sub>c</sub>) is lower than the base case (149 kg CO<sub>2</sub>/MWh<sub>c</sub>).

The results have also suggested that there is significant amount of excess heat available from solar field which could not be stored in SRACS boundaries. It is worth looking at additional processes, which may require heating or cooling, where this excess heat/cool can be utilized. This can further lower down the CO<sub>2</sub> emissions.

---

## 5 Comparison of Solar PV and Thermal cooling systems for industrial cooling applications

---

### 5.1 Introduction and aims

The main aim of this case study is to assess the technical and economic feasibility of retrofitting industrial process cooling systems with solar cooling systems, as an interesting alternative solution, which could conclude to reduction in CO<sub>2</sub> emissions in the energy sector, ensure electric grid stability and reduce future cost uncertainties for process cooling.

The two main technologies considered for solar cooling are either with photovoltaic systems producing electricity or solar thermal collectors producing heat. While the electricity can be used to drive a conventional electric vapour compression chiller, heat can be used to drive a thermally driven chiller. For solar thermal cooling, absorption cooling machines are the most used technology among thermally driven chillers.

This case study describes the comparison of solar cooling with either a photovoltaic system or a solar thermal system using a thermally driven chiller. The application investigated was industrial process cooling, for three load profiles and three locations in Europe. The method of comparing was by simulations in TRNSYS and calculation of the global levelized cost of cooling taking into account the total cost of covering the whole cooling demand.

The results for the global levelized cost of cooling showed that solar thermal cooling have strong competition with photovoltaic cooling system for any of the investigated boundary conditions, mainly due to different COPs. However, the general trend was that the global LCOC for the solar thermal cooling increased with the solar cooling fraction. The photovoltaic solar cooling system global LCOC was in parity with the reference system for low SCF of 20 % to 30 %, and even up to 60 % for some boundary conditions. The main aim is to assess the technical and economic feasibility of retrofitting industrial process cooling systems with solar cooling systems.

### 5.2 Methodology

Defining the boundary conditions for an industrial process cooling reference system. The reference system will be used for building the system model and for comparison with the different solar cooling systems.

As the performance of solar cooling systems are greatly affected by temperature levels, load profiles and solar irradiance, the dynamic simulation tool TRNSYS was used. The simulations were used to obtain energy performance data at different boundary conditions and SCF to be used in further calculations.

The simulated results were then imported into Microsoft Excel where they were used to calculate the LCOC. A sensitivity analysis was performed to investigate the impact that different boundary conditions could have on the LCOC.

### 5.3 Limitations

Only European locations were investigated (three locations with significant variations in solar irradiation were chosen). This, however, restricts the degree of which general conclusions can be made from the results, especially considering that solar thermal systems are not only sensitive to radiation, but also to ambient temperatures as well.

Only one type of photovoltaic module, solar thermal collector, thermally driven chillers, electrically driven chillers, and heat rejection system were simulated. There are a variety of different types within the respective technology. However, the types considered have been used in previous research.

Fixed temperatures for the cooling load, and no variable load. This could depict a typical process cooling load, with stringent requirements on cooling temperatures. Such industries may include dairy, food and beverage, pharmaceutical sectors etc.

No energy storage was considered, either for storing electricity or thermal energy. The focus is comparing the LCOC when all the heat/cold is utilized for low solar fractions, which limits the need for storage tank.



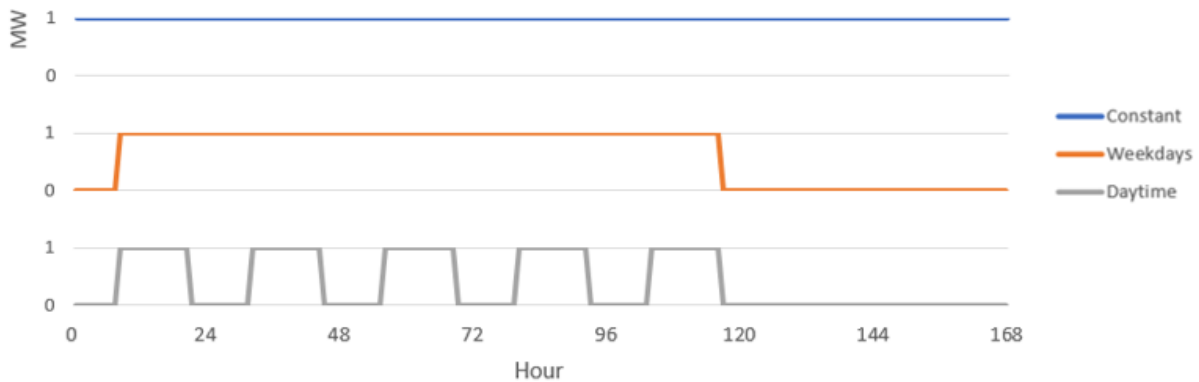
## 5.4 System description

The type of system considered was an industry with a working compression cooling system, called the reference system, where the intention was to increase the use of solar energy. The reference system would either be retrofitted with a PV system to replace grid electricity or supplemented with a ST system and an absorption chiller. No backup heat was to be used for the absorption chiller, instead the old compression chiller would be used for backup cooling.

### 5.4.1 Cooling loads and locations

The systems were designed for an assumed industrial process cooling profile with a peak cooling load of 1 MW. The weekly load profiles that were intended to represent different operating conditions, while still having the same peak demand for the process cooling as visualized in figure 3.1 below and consisted of:

- Constant – There was always a cooling load throughout the year
- Weekdays – There was only a cooling load during the weekdays
- Daytime – There was only a cooling load on daytime during the weekdays



**Figure 19: Weekly process cooling load profiles**

As can be seen in **Error! Reference source not found. 19** there was either no cooling load or full cooling load, no part load. The weekly cooling loads were used throughout the year with no stops or changes for vacations, holidays, or maintenance. The annual cooling demand can be seen in Table .

*Table 5: Annual cooling demand and peak cooling loads for the three different weekly cooling load profiles.*

| Load profile | Annual cooling demand [MWh] | Peak cooling load [MW] |
|--------------|-----------------------------|------------------------|
| Constant     | 8,760                       | 1                      |
| Weekdays     | 5,685                       | 1                      |
| Daytime      | 2,610                       | 1                      |

The temperature of the water supplied to the cooling load, the chilled water, was set to 7°C and the return from the cooling load was 12°C. Three different locations were considered to investigate the impact that different climates/locations could have on the system (Berlin, Genova, and Almeria). Relevant parameters for the locations are shown in Table 6.

*Table 6: Annual values and important information for the three different locations*

| Data                             | Berlin, Germany | Genova, Italy | Almeria, Spain | Source |
|----------------------------------|-----------------|---------------|----------------|--------|
| Latitude [°N]                    | 52.5            | 44.4          | 36.8           | [1]    |
| Annual GHI [kWh/m <sup>2</sup> ] | 1,066           | 1,423         | 1,873          | [1]    |
| Annual DNI [kWh/m <sup>2</sup> ] | 973             | 1,432         | 2,003          | [1]    |
| Optimum tilt for PV [°]          | 38              | 36            | 31             | [1]    |
| Average PV output [kWh/kW]       | 1,066           | 1,374         | 1,757          | [1]    |
| Temperature [°C]                 | 10.0            | 15.4          | 19.1           | [1]    |

Climate classification

Dfb:  
Cold, without dry  
season, warm  
summer

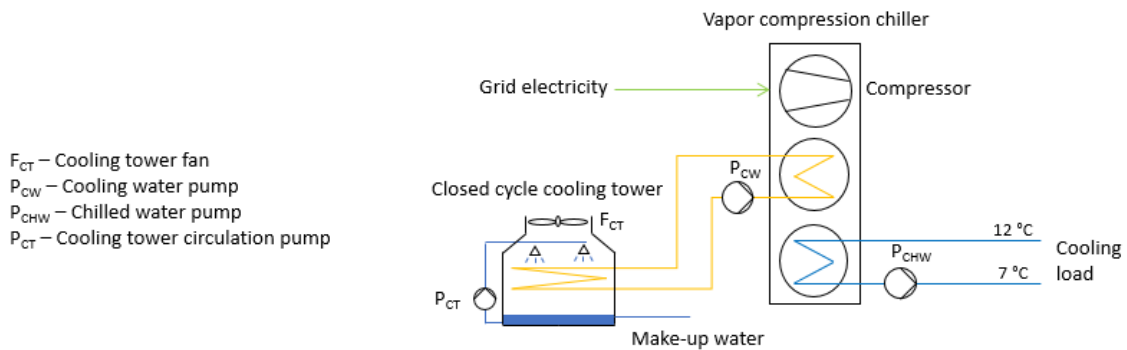
Csa:  
Temperate, dry  
summer, hot  
summer

BSh:  
Arid, steppe, hot

[2]

## 5.4.2 Reference cooling system

The reference system was based on a modern vapor compression chiller powered by grid electricity. The chiller was sized to 1.1 MW to have some margin to cover the cooling load at the worst-case operating conditions. A closed cycle cooling tower was used to reject the heat from the chiller. Figure shows a schematic over the components in the reference system.

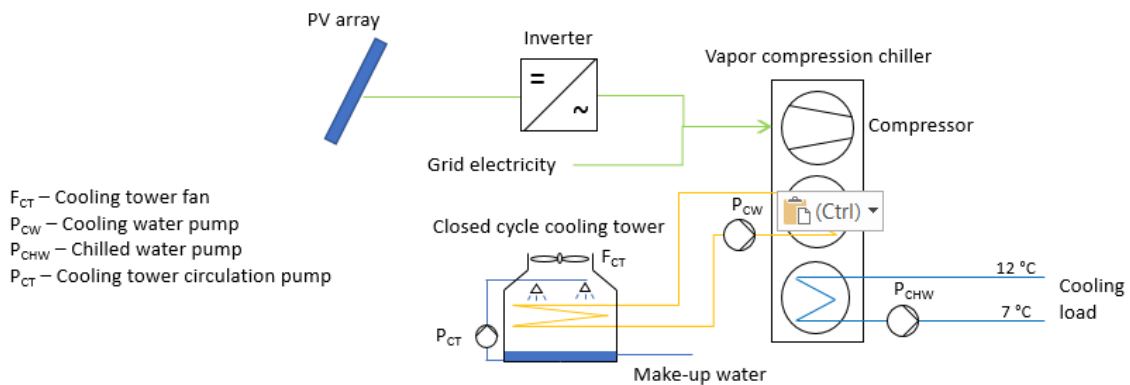


**Figure 20: The most important components in the reference cooling system**

As the reference system was intended to represent a cooling system with an existing but still modern chiller, a chiller with rated COP of 3 and 5 was investigated to compare the impact on LCOE. To simplify, the same pump characteristics was used for all applications, however with different maximum power.

## 5.4.3 PV cooling system

The only difference between the reference cooling system and the PV cooling system was that a PV system supplied electricity to the chiller and the auxiliary equipment. Figure shows the main components of the PV cooling system.

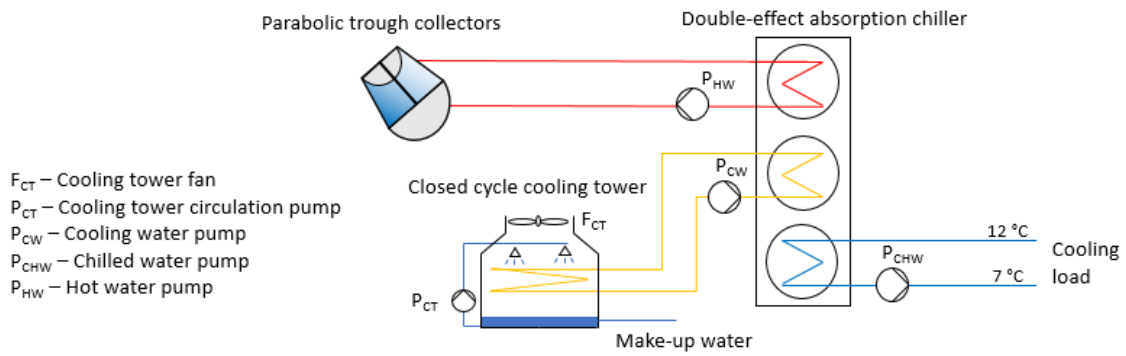


**Figure 21: The most important components in the PV cooling system**

The PV modules used was silicon mono-crystalline with an efficiency of 19.3 % and the inverter was from SMA with a maximum efficiency of 98.8 and a euro efficiency of 98.6.

## 5.4.4 Solar thermal cooling system

The solar thermal cooling system was based on retrofitting the existing vapor compression chiller cooling system. This was done by adding a solar thermal system together with a double effect absorption chiller, and a separate cooling tower. The existing electric chiller (as in reference case without PV) was kept as a backup for when the solar thermal system was unable to meet the load. No backup heating supply for the absorption chiller was considered. While the backup cooling system was the same as described in Chapter 4.3, the ST part of the cooling system can be seen in Figure .



**Figure 22: The most important components in the ST part of the cooling system are shown**

To simplify the system, the water heated by the collectors was used directly in the absorption chiller without any heat exchanger. Parabolic through collectors were commercial manufacturer were selected for analysis. The hot water fired double effect absorption chiller was selected. The most important parameters for the equipment considered can be seen in Table 7.

*Table 7: Parameters for the equipment considered in the ST cooling system.*

### Collectors

|   |             |
|---|-------------|
| Efficiency coefficient $a_0$                        | 0.72        |
| Efficiency coefficient $a_1$ [W/m <sup>2</sup> /°C] | 0.359       |
| Efficiency coefficient $a_2$ [W/m <sup>2</sup> /°C] | 0.0009      |
| Maximum temperature [°C]                            | 200         |
| Type of tracking                                    | Single axis |

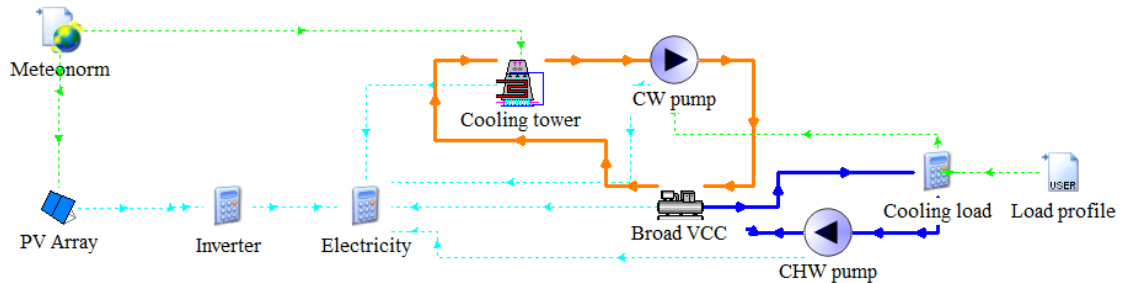
### Double-effect Absorption Chiller

|  |                  |
|--|------------------|
| Rated COP (incl. electricity demand)       | 1.50             |
| Rated hot water temperatures [°C]          | 180/165          |
| Rated chilled water temperatures [°C]      | 7/14 or 7/12     |
| Rated cooling water temperatures [°C]      | 37/30 or 37.5/32 |
| Min. chilled water outlet temperature [°C] | 5                |
| Min. cooling water inlet temperature [°C]  | 10               |
| HW performance data range [°C]             | 165-180          |
| CHW performance data range [°C]            | 5-10             |
| CW performance data range [°C]             | 24-32            |

The backup chiller, cooling tower and pumps were the same as used for the reference system described in Chapter 4.3. The collector setup was 8 collectors connected in series.

## 5.5 Simulation models

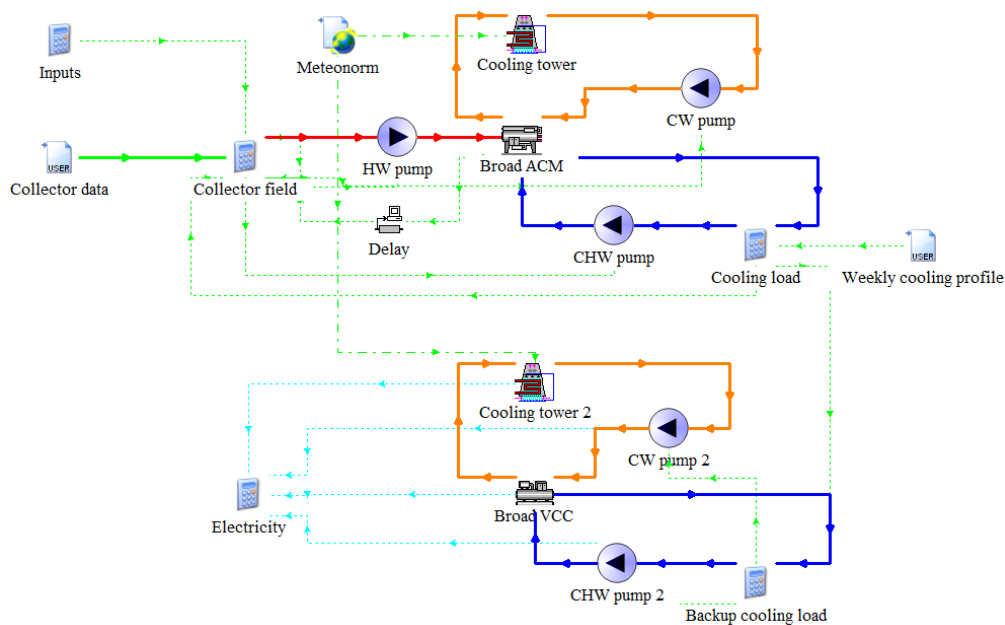
System models including a reference cooling system, solar PV cooling system and solar thermal cooling system were built with the TRNSYS simulation software. As the PV solar cooling system was the same as the reference system without PV, the same model was used. The main components of the model were the PV array, compression chiller, cooling tower, cooling water pump, and the chilled water pump. The cooling tower fan was integrated in the cooling tower model. Figure 23 shows the setup and connections in TRNSYS.



**Figure 23: Reference and PV system TRNSYS model**

The load profile described was read from an external text file with a TRNSYS data reader named “Load profile”. The equation component “Cooling load” was used to simulate the cooling load, with a fixed chilled water return temperature of 12 °C to the chiller and also for controlling the pumps

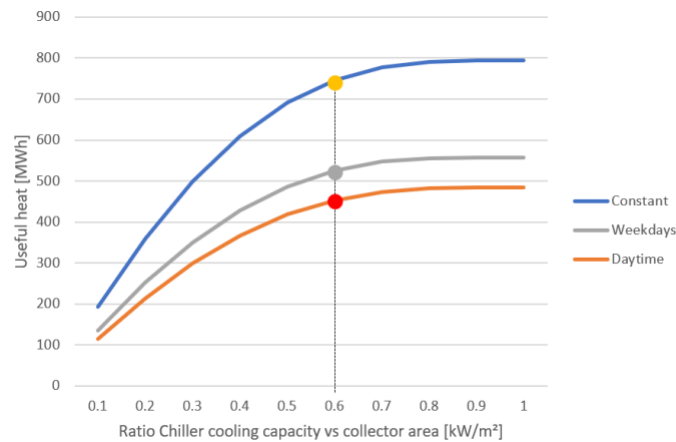
The ST solar cooling model consisted of both the ST system with absorption chiller and separate cooling tower, as well as a copy of the reference system for backup with the PV components removed. 24 shows the TRNSYS model.



**Figure 24: Solar thermal solar cooling system TRNSYS model**

As for the compression chiller model in the reference system, the “Broad ACM” component model calculates the heat input needed to keep the outlet chilled water set point temperature of 7°C based on the cooling load. Because the heat input from the collectors was the deciding factor of the operation of the ACM and no backup heating was used, the “Collector field equation” was used to control the pumps. The operation of the chiller was based on the available energy from “Collector data” that read hourly collector output data supplied by manufacture. This output was then used to calculate the highest possible flow rate of the “HW pump”, while still maintaining the temperature difference for the hot water supplied to the chiller. The inlet temperature to the chiller was set to always maintain 180°C and the hot water flow rate was not allowed to exceed the maximum allowed flow rate for the “HW pump”. The relative flow rate of the “HW pump” was then also used to control the “CHW pump” and the “CW pump”. The

maximum flow rates for each chiller capacity were set based on nominal flowrates for the chiller catalog, where the nominal flows all had a linear relationship to the nominal cooling capacity. This relationship was used to size the pumps in relation to the chiller capacity, which in turn was determined by the collector area up to 1,000 kW chiller cooling capacity. The sizing of the chiller in relation to the collector field was based on calculations showed in Figure 25. As there were no cold storage, no reason was found to use a chiller with a higher cooling capacity than the peak cooling load.



**Figure 25: Calculation results for determining chiller size in relation to collector field area. The ratio of 0.6 kW of chiller cooling capacity per m<sup>2</sup> collector was chosen**

The collector field area was changed in the “Inputs” component similarly as for the PV size, with increments of complete sets of series connected collectors. The number of collectors in series was 8. The system models were simulated for different boundary conditions and solar cooling fractions. The levelized cost of all cooling supplied to the load in € per MWh at different solar cooling fractions was used to compare the reference, PV, and ST cooling systems as shown in Equation below. The term turnkey is used here to represent all costs for the components and the necessary additional costs, including installation and commissioning. A lifetime of 15 years was considered, as it is typical for industries to use a time frame of 15 years while planning their CAPEX for new investments

$$LCOC = \frac{C_0 + \sum_{t=1}^N \frac{O\&M}{(1+r)^t}}{\sum_{t=1}^N \frac{Q_c}{(1+r)^t}}$$

Where:

- $C_0$  is the initial turnkey investment cost for the system components in €
- $O\&M$  are the discounted operational and maintenance costs for the system over N years in €
- N is the time period evaluated in years
- $Q_c$  is the total annual cooling supplied to the cooling load by the system in MWh
- $r$  is the discount rate in %

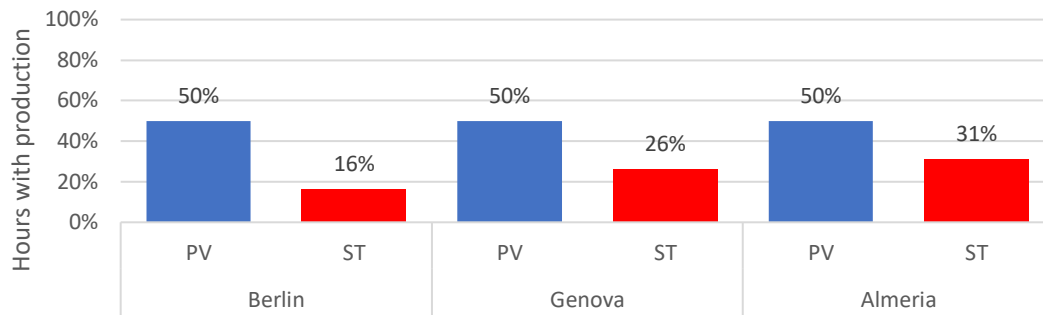
## 5.6 Solar energy production output

The simulated production of electricity from PV and heat from ST was analysed for the three different locations. Table 8 shows the annual outputs for the two technologies.

Table 8: The simulated annual energy output and the expected PV output

|   | Berlin | Genova | Almeria |
|---|--------|--------|---------|
| Simulated ST output [kWh/m <sup>2</sup> ] | 240    | 490    | 660     |
| Simulated PV output [kWh/kW]              | 1100   | 1500   | 1800    |

The production profiles show that the two technologies have similar profiles for Berlin and Almeria but differ more in shape in Genova. The number of hours where production occurred was also analysed. Below Figure 26 shows the percentage of hours over the whole year with non-zero production output. This is vital information as the systems did not use any type of energy storage, which makes the coincidence of cooling load and production important.



**Figure 26: Percentage of hours over the year that were some heat or electricity produced for the different systems and locations.**

**Error! Reference source not found.**26 shows that the PV system has some amount of production in 50 % of the annual hours. The ST system only have production in 16 %, 26 % and 31 % in Berlin, Genova, and Almeria, respectively. This limits the achievable SCF, and for constant load it can be directly translated to the limit of SCF as a system increase would not affect this value.

## 5.7 Global LCOC

The global LCOC is calculated as the total cost of cooling to cover the whole cooling demand. The results are first shown for the constant load profile, followed by the weekdays load profile, and lastly the daytime load profile. The parameters used for the base case LCOC calculations are shown in Table 9 below. The LCOC of solar (PV and thermal) are calculated using Vapor compression cooling (VCC) at COP of 3 and 5.

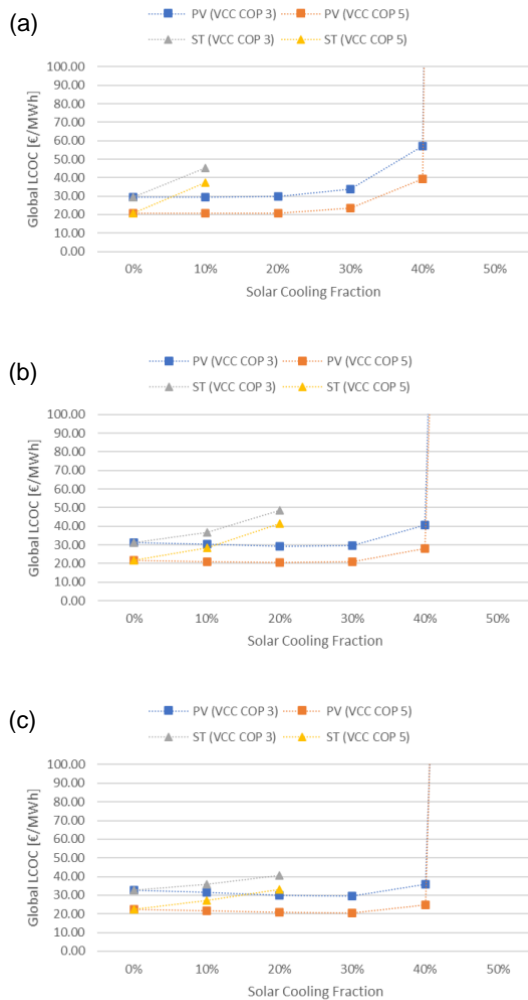
*Table 9: Parameter values used for the base case LCOC calculations*

| Parameter  | Value |
|--|-------|
| Turnkey PTC solar thermal system [€/m <sup>2</sup> ]   | 350   |
| Turnkey PV system [€/kW]                               | 850   |
| Turnkey double effect absorption chiller (ACM) [€/kW]  | 175   |
| Turnkey closed cycle cooling tower (CT) [€/kW]         | 35    |
| ST maintenance cost relative to C <sub>0,ST</sub> [%]  | 0.8   |
| PV maintenance cost relative to C <sub>0,PV</sub> [%]  | 1     |
| CT maintenance cost relative to C <sub>0,CT</sub> [%]  | 5     |
| ACM maintenance cost relative to C <sub>0,CH</sub> [%] | 5     |
| Cost of water [€/m <sup>3</sup> ]                      | 1.65  |
| Cost of heating  | 0     |
| F <sub>PV</sub>  | 0     |
| F <sub>ST</sub>  | 0     |
| Discount rate [%]                                      | 6     |
| Electricity costs (without taxes) [€/kWh]              | 93    |
| Investment lifetime [years]                            | 15    |
| Residual Value [€]                                     | 0     |

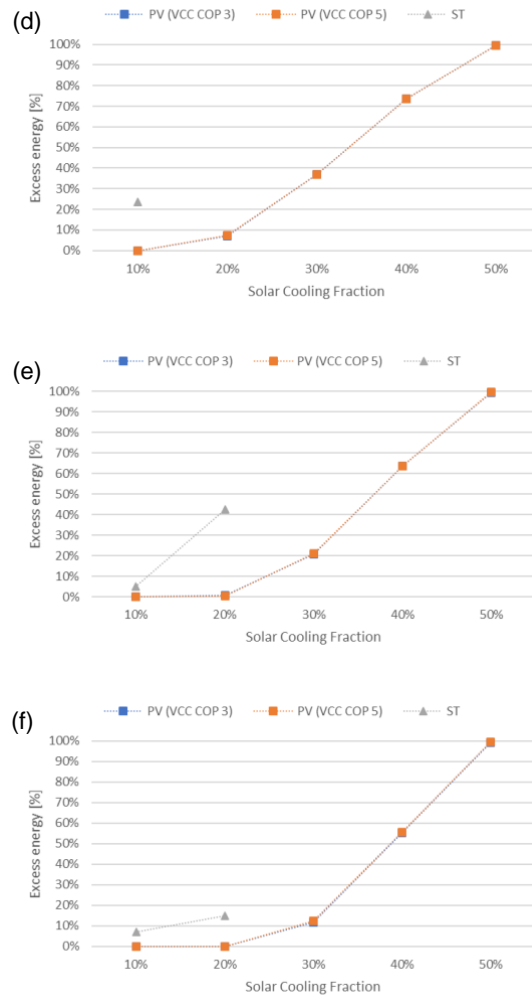
## 5.8 Results

### 5.8.1 Constant load

Figure 27 shows the base case global LCOE for the three locations using the constant load profile. Figure 28 shows how much excess electricity was produced relative to the useful electricity from PV, and similarly for excess heat from ST.



**Figure 27: Base case LCOE for constant load and in (a) Berlin, (b) Genova, (c) Almeria. Note that the Y-axis was limited to 100**

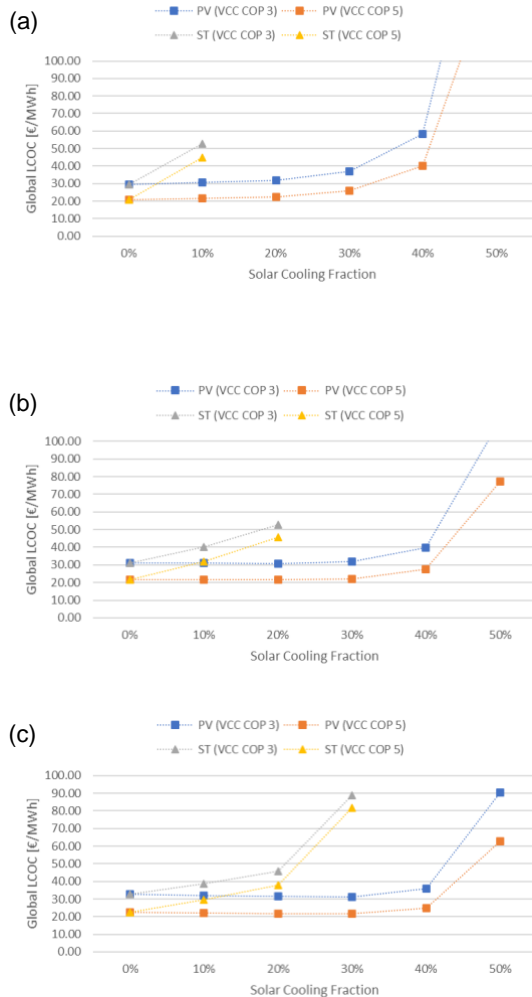


**Figure 28: The share of excess heat or electricity for constant load relative to the total produced in (d) Berlin, (e) Genova, (f) Almeria**

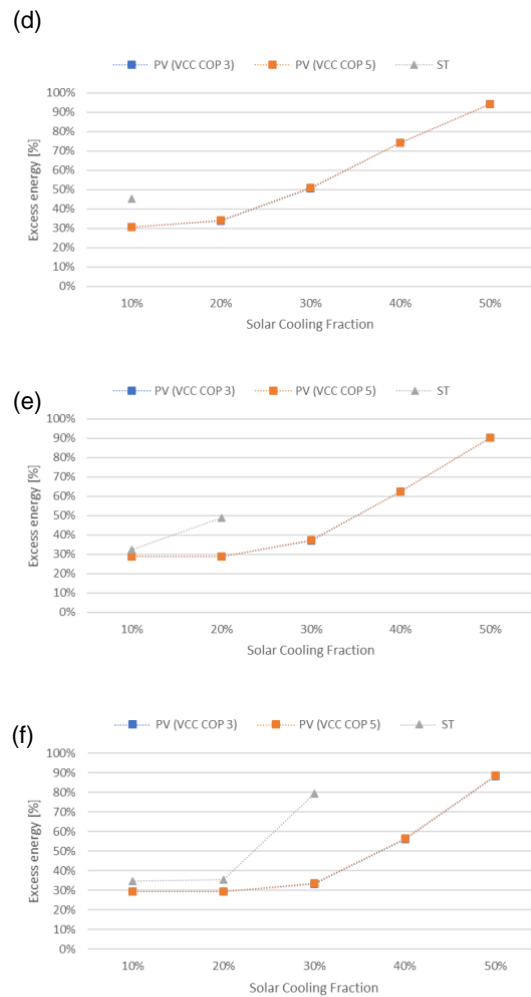
The results for constant load shows that ST cooling has higher Global LCOE than the PV cooling for all three locations. The PV cooling system shows similar LCOE as the reference system (0 % SCF) for SCF up to 30 %, while the ST system LCOE is always higher than the reference system. The ST system shows excess heating at 10 % SCF which then increases with the system size, for all locations. PV system shows excess electricity from 20 % in Berlin and 30 % in Genova and Almeria. When aiming for high SCF without storage, the PV and ST system becomes extreme, and the excess also increases drastically.

## 5.8.2 Weekday's load

Figure 29 shows the base case global LCOC for the three locations using the weekdays load profile. Figure 30 shows how much excess electricity was produced relative to the useful electricity from PV, and similarly for excess heat from ST.



**Figure 29: Base case LCOC for weekdays load and in (a) Berlin, (b) Genova, (c) Almeria. Note that the Y-axis was limited to 100**



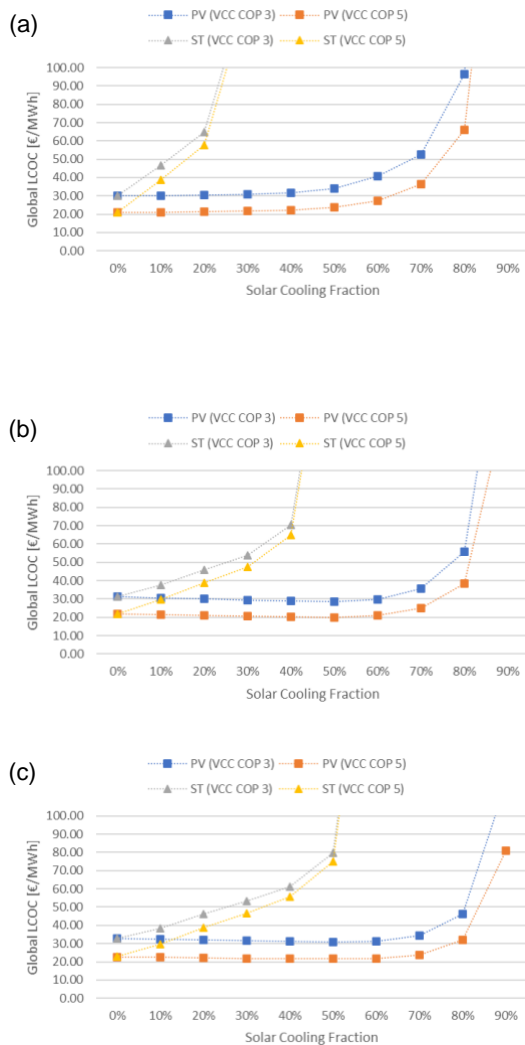
**Figure 30: The annual share of excess heat or electricity for weekdays load relative to the total produced in (d) Berlin, (e) Genova, (f) Almeria**

The results from the weekdays load shows the same trend as for the constant load. ST always have a higher global LCOC than the PV system. There is excess energy from both systems for all SCF, explained by the mismatch of production and cooling demand, as there is no cooling demand over the weekends. The achievable SCF for Almeria increased to 30 %, although the LCOC is much higher due to oversized collector field.

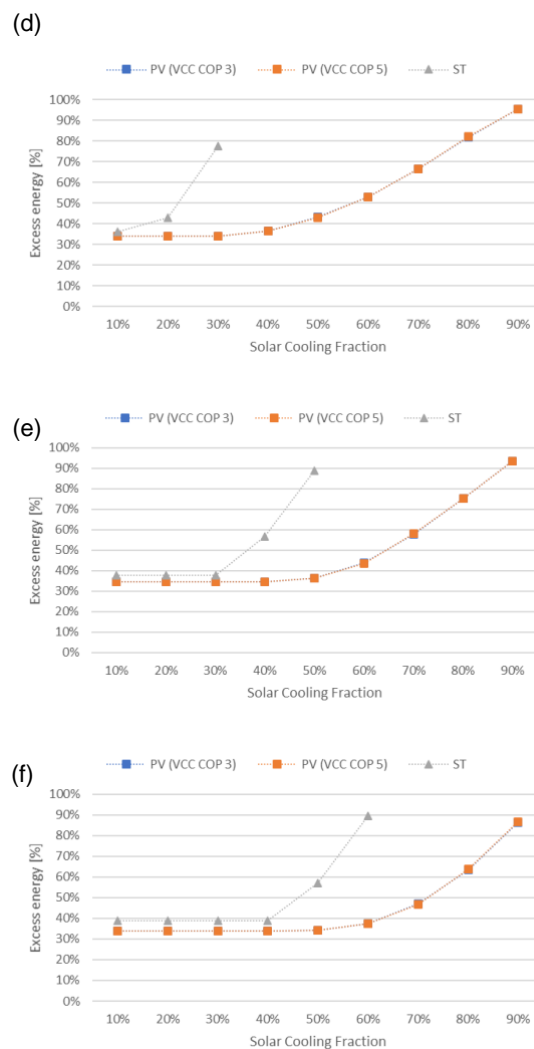


### 5.8.3 Daytime load

Figure 31 shows the base case global LCOC at different SCF for the three locations using the constant load profile. Figure 32 shows how much excess electricity was produced relative to the useful electricity from PV, and similarly for excess heat from ST.



**Figure 31: Base case LCOC for daytime load and in (a) Berlin, (b) Genova, (c) Almeria. Note that the Y-axis was limited to 100**



**Figure 32: The annual share of excess heat or electricity for daytime load relative to the total produced in (d) Berlin, (e) Genova, (f) Almeria**

The results for the daytime load follows the trend of the other two cooling loads, ST system is always higher than the PV system and increases with increased SCF. The achievable SCF is however increased for both systems. The PV system has similar LCOC as the reference system up to 40 % SCF for Berlin, and up to 60 % to 70 % for Genova and Almeria. The excess energy from both systems is also kept constant for higher SCF compared to the previous two cooling loads.

## 5.9 Discussion

For all the analysed cases, the PV cooling system results in comparatively lower LCOH than ST system. However, with lower COP of electrical chiller, the Solar thermal cooling system becomes competitive.

One major factor can be that the ST system includes the cost of the collectors as well as the absorption chiller and the extra cooling tower. ST also increases the water costs due to higher demand for heat rejection, caused by the lower COP of the absorption chiller compared to the compression chiller. The ST energy output data also showed fewer hours of production compared to PV, which has a big impact on the usable energy and the achievable SCF without the means to store the excess energy. The ST output decreases significantly due to higher operation temperatures, which further reduces the economic competitiveness.

Due to system assumptions for having no energy storage especially for ST system, when trying to achieve high SCF the systems become extremely oversized, and at some point, they can be seen more as a heat or electricity production systems rather than for cooling applications. No upper size limit was set in this study but should be taken into account when analysing the results.

It could also be seen that the location and climate have a significant impact on both the technical and economic feasibility of solar cooling. Moreover, the global LCOC for PV decreased slightly for some combinations of load and location in lower PV sizes due to having no excess energy yields.

The result analysis was performed for system designs, locations, and assumptions with emphasize on VCC system (as the reference system is considered a VCC machine). Other possibilities could be to assume two separate reference system, i.e., reference VCC and ACM (using grid electricity and grid heat) and evaluate the SCF by implementing PV and PTC field for each system, respectively.

As emphasized by this study, Solar cooling with parabolic trough collectors and double effect absorption chiller is not competitive compared to retrofitting a modern vapour compression chiller with high COP with a photovoltaic system. Absorption chiller with solar thermal are useful to replace the low COP compression chillers. But as this study tries to evaluate the SCF and therefore the PTC field is assumed for producing heat. Energy storage is important to reach high solar fractions

---

## 6 Combined compression-adsorption cooling system: Results from HyCool project

---

### 6.1 Introduction and aims

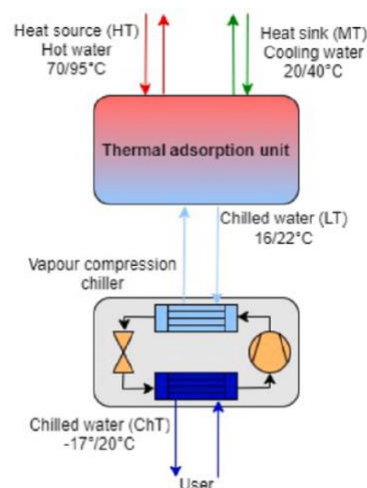
The energy demand of industries accounts for about 35% of world yearly energy consumption, a relevant percentage arises from heating and cooling demand. Solar heating and cooling technologies can be integrated in industrial processes to reduce the fossil fuels consumption as well as the related greenhouse gas emissions.

HyCool project brings 15 partners from across the EU together to develop a cost-effective hybrid solar system solution that combines the technology in Fresnel solar thermal collectors, hybrid adsorption compression chillers, and thermal storage fields. Designing and implementing the systems in two industrial pilots, by reducing costs while allowing flexible and the easy integration of the system into existing industrial environments.

### 6.2 HyCool hybrid chiller

In experimental analysis of a novel hybrid sorption-compression chiller for cooling and refrigeration is used as shown in Figure 33. The hybrid chiller consists of a thermal adsorption chiller which produces chilled water, which is further used for condenser of a vapor compression chiller. An adsorption unit, powered by hot water, serves as the warm stage of the cascade. This adsorption process produces cold water at a low thermal level. The colder stage of the modular hybrid heat pump operates through a compression refrigeration unit. These two mechanisms are integrated: the cold water generated by the adsorption system is utilized to dissipate heat in the condenser of the colder stage. As a result, the temperature difference between the evaporator and the condenser in the compression circuit is minimized. This leads to enhanced energy efficiency and a reduction in compressor power consumption.

The adsorption chiller uses silica gel/water for the sorption cycle and a low Global Warming Potential (GWP) refrigerant, i.e. Propene for the compression cycle. The experimental results highlight the flexibility of the system in terms of performances and operating conditions, these are compared to the theoretical performances, and it is found out that electricity energy savings from 15% to 25% can be achieved when using the hybrid system over a compression one with the same cooling capacity.



**Figure 33: Schematic of an Hybrid Adsorption-compression chiller developed in HyCool project**

A 19 kW<sub>e</sub> system is installed as part of the project, and the experimental evaluations are conducted. The analysis of experimental results is carried out not only to define a complete performance map of the system, but also by comparing the operation of the hybrid chiller proposed with a reference compression one, highlighting the advantages and critical points in the operation of hybrid systems, which allows scholars and industrial players to define the best strategies for a sound and reasoned optimization of the hybrid chillers for industrial applications.

From gained results of this project, which can be highlighted that reducing the heat source temperature from 85°C to 70°C introduces a penalisation in the performance of the chiller that goes from 6% to 10%, both for EER and

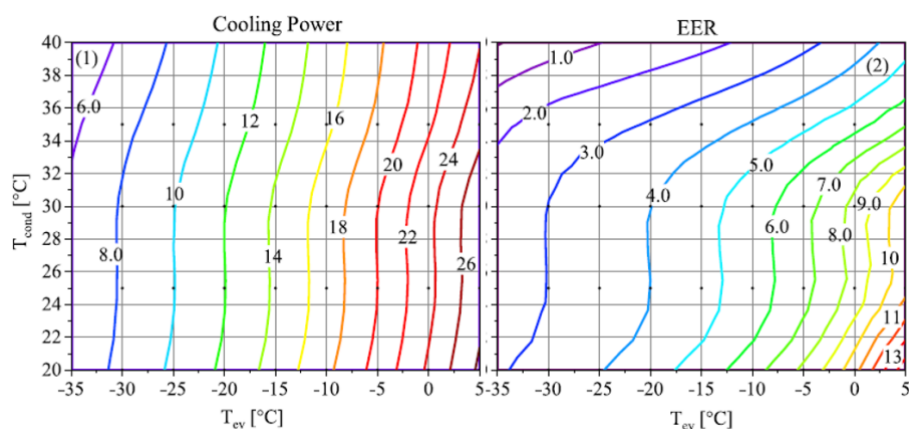
cooling capacity. Such a reduction of cooling capacity and EER with the temperature is slightly higher for higher evaporation temperatures (around 15% for ChT of 0°C and above).

Such a result is strictly dependent on the choice of the sorbent in the sorption unit, i.e. silica gel that can be effectively regenerated also at lower temperatures. This is an important outcome since it proves the reliability of the chiller also under conditions in which the heating source is characterized by a high variability (e.g. solar systems in the first and last hours of the day, in partially cloudy days, northern latitudes) and indicates a high flexibility of the proposed solution.

So, as the deployment of adsorption cycles for heating and cooling purposes is often limited by poor efficiency and high reactor volumes, which both determined by the absorber material used. The appropriate pre-selection of the solid sorbent and the system design in the early stages of design can allow quick identification of the most promising solutions. Therefore, a reliable and robust methodology for absorber material screening and preselecting is proposed and applied to a test set of state-of-the-art candidates. The improvement achieved in the adsorption equilibrium prediction with respect to the most frequently used model is above 60%. In addition, the absorber material selection framework based on mixed-integer linear programming was applied to over 600 hypothetical cooling and mixed cooling/heating use cases. The analysis of exergy and volume performances allowed to emphasize differences of design strategies using different system objectives (i.e. minimizing the temperature of the heat sources and choosing compact materials).

### 6.3 System performance map

Experimental results were transformed into performance maps and then analyzed using a statistical model. This process aimed to develop a simplified formula that allows end-users to assess the hybrid system's overall efficiency based on measurable variables, such as operating temperatures. Optimization techniques were identified to enhance the chiller's performance, specifically by reducing its electricity consumption. This improvement can be achieved by managing the sorption cycle to control the intermediate temperature (the evaporation temperature of the sorption chiller) and by adjusting pump speeds in all circuits. Such adjustments are especially effective in reducing unnecessary energy use during periods of low demand.



**Figure 34: Performance map of chiller a) cooling capacity b) EER**

The thermodynamic analysis's primary findings are illustrated in Figure 34. This figure emphasizes the impact of varying evaporation and condensation temperatures on both the cooling power and the Energy Efficiency Ratio (EER). The thermodynamic calculations aimed to discern the influence of operating conditions, especially pinpointing the most favorable conditions for the chiller's operation. The cooling power remains relatively stable within the condensing temperature range of 22 to 30°C. However, a linear decline is evident when the temperature exceeds 30°C. The EER mirrors this pattern: it remains consistent between 22°C and 30°C, but a linear drop is observed for  $T_{cond} > 30^\circ\text{C}$ . Notably, the decline in EER is more pronounced than that of the cooling power.

### 6.4 Validation

Validation of dynamic modelling of a hybrid cascade chiller for solar cooling in industrial applications driven by Fresnel solar thermal collectors has been considered. The ongoing installation is in Barcelona, where Fresnel

collectors of 400 m<sup>2</sup> are used to drive the HyCool chiller of 20 kW cooling capacity. The system utilises a dry re-cooling system. 3 thermal storages are planned in the system: Two hot water storage system at 120°C and 85°C respectively, and one cold water storage at 6°C. The evaluation of the system has shown that The evaluation of a that EERs between 7-8 can be reached reducing the electrical power consumption by 44 % during summer.

The Dymola/Modelica modelling of a cascade hybrid adsorption/vapour compression chiller driven by concentrating solar thermal collectors for industrial applications was presented. The two main sub-systems, namely, the adsorption module and the vapour compression chiller, were modelled considering heat and mass transfer properties for each component, both on the HTF and on the refrigerant side. This cascade configuration allows enhancing the overall electric COP, since the adsorption module is operated to dissipate the heat rejected by the vapour compression chiller, thus reducing the condensation temperature quite below the ambient temperature. The implemented system was validated by means of experimental data obtained on a small-scale cascade chiller developed by Fahrenheit and tested at the CNR ITAE lab. Finally, the validated model was used to verify the ability of the cascade chiller to operate under a typical daily cooling profile in an industrial site in Spain. Starting from the developed and validated model, future activities will be oriented towards the operation optimization of the chiller, in terms of matching between thermal and electrical energy provision as well as minimization of the operation under part load conditions. The detailed deliverables of the project can be obtained at <https://hycool-project.eu/publications-and-results/project-deliverables/>

## 6.5 Energy and environmental benefits of hybrid cascade chillers

The work conducted in the project regarding evaluation of the performance of a cascade chiller, having an adsorption cycle as topping cycle and a vapour compression cycle as bottom cycle. An experimental testing campaign was carried out at CNR ITAE, focused on the definition of performance aspects of the system under different operating conditions. In particular, heat source temperatures between 70°C and 85°C were evaluated, cooling temperatures between 22°C and 40°C and chilled water temperatures of -12°C up to 5°C, in order to reproduce the operation in different seasons, climates and user requests (i.e. air conditioning and refrigeration). Cooling powers from 18 kW (under air conditioning conditions) from 12 kW (for refrigeration conditions) were obtained for the lower cooling temperatures. Indeed, the cooling temperature has a great influence on the cooling capacity of the system, whereas heat source temperature has a smaller effect on the capacity of the system. Finally, the energy savings that can arise from such a configuration were calculated and up to 25% reduction, if compared to a standard vapour compression system can be achieved. A reduction in CO<sub>2</sub> emissions up to 3.5 yearly tons were calculated as well.

The cooling power measured was between 8 kW (at - 17°C outlet temperature of the heat transfer fluid) and 23 kW (at +20°C outlet temperature of the heat transfer fluid). The chiller is able to provide cooling power with an appreciable EER, around 2.5 when the ambient temperature is 30°C, even at - 11°C. This confirms the ability of the machine to operate far from the nominal conditions. The results of experiments were compared to the theoretical performances, and it was found out that electricity energy savings from 15% to 25% can be achieved when using the hybrid system over a compression one with the same cooling capacity and refrigerant range depending on the operating conditions. Optimization strategies identified for a further enhancement of the performance of the chiller, i.e. the reduction of the electricity consumption, include the possibility of controlling the intermediate temperature (evaporation temperature of the sorption chiller) through sorption cycle management and the use of variable speed of the pumps in all the circuits to reduce the parasitic consumption especially at low part loads.

From industrial implementation, it was determined that full load operation conditions of minimum 3,800 h and ambient heat rejection conditions with above 20°C must occur constantly through operation period, to enable an overall economic operation of the hybrid chiller. Moreover, it was analysed that the solar assisted HHP system is likely feasible for the implementation into industrial process typologies with both, heat and cold demands.

## 6.6 Discussion

The innovative approach of the hybrid chiller has the potential to redefine the benchmarks set by current cooling chillers. Nonetheless, the considerable initial investment and ongoing operational expenses might constrain its market appeal. Subsidies and policy backing could enhance its commercial viability, drawing the attention of industrial investors. By incorporating a topping cycle, the electricity consumption of the compression chiller can be minimized, thereby mitigating the impact of fluctuating electricity prices. Going forward, the focus should be on large-scale deployment and standardization.

---

## 7 Conclusion

---

This report offers a concise overview of multiple case studies gathered during activity B2 in IEA SHC Task 65. Its primary objective is to present a summary of current cooling installations and simulation studies, highlighting their essential features. Additionally, three distinct case studies, each with its unique scope and attributes, are elaborated upon. The summary is as follows:

- **Industrial cooling potential:** As demonstrated in Case Study 1, industrial cooling presents a substantial prospect for solar cooling applications. Such systems can achieve a high solar fraction, significantly reducing CO<sub>2</sub> emissions when compared to traditional electricity-driven chillers.
- **Solar PV and vapor compression chillers:** Case Study 2 explores the integration of solar PV with vapor compression chillers as an emerging solution for the decarbonization of cooling systems. A comparative analysis, considering various load and weather profiles, suggests that solar PV cooling can lead to a reduced levelized cost of cooling compared to solar thermal. The study highlights the importance of thermal storage and the efficacy of lower temperatures in solar thermal collectors for cost competitiveness.
- **Hybrid electrical and thermal chillers:** Case Study 3, based on the HyCool project, emphasizes the potential of combining electrical and thermal chillers. Both simulation and real-world results indicate a notable reduction in electricity consumption when utilizing the topping cycle of an adsorption chiller. Advancements in policy and economies of scale will further enhance the cost-effectiveness of such innovative approaches.

In conclusion, these case studies underscore the transformative potential of cooling solutions. As technology advances and policies evolve, the adoption of such systems will play a pivotal role in shaping a greener and more energy-efficient cooling future.

### Questionnaire for design guidelines

**SHC**  
SOLAR HEATING & COOLING PROGRAMME  
INTERNATIONAL ENERGY AGENCY

**SOLARCOOLING®**  
SUNBELT REGIONS  
TASK65

**Subtask B - Activity B2 - Design guidelines**

*First of all, thanks for your commitment to contribute in Subtask B, and Activity B2. The main aim of this subtask activity is to develop the system and integration guidelines for solar cooling systems. This is the template for a first exploratory survey of various parameters required to develop these guidelines. We appreciate your time and efforts for filling out this questionnaire with reasonable details.*

**How to fill this questionnaire**

*The questionnaire is quite straightforward. It consists of 4 sheets to fill-in the information.*

- Sheet 1 is about general information of the solar cooling project.*
- Sheet 2 can be used to input the detailed parameters for cooling load and backup system*
- Sheet 3 gather information on various components of solar cooling system*
- Sheet 4 can be used to attached any appendences*

*Note! The template is not password protected. So, feel free to modify/add sheets if needed*

*For any questions/queries /clarifications please feel free to contact at [puneet@absolicon.com](mailto:puneet@absolicon.com)*

0. Start | 1. General information | 2. Load and Back up | 3. Solar cooling system | 4. Appendix

# 1. General information



| GENERAL INFORMATION  |  |                  |
|--|--|------------------|
|  |  | Remarks (if any) |
| Contact information  | Person's name who is filling this form |                  |
|  | Organization and Affiliation           |                  |
|  | Email                                  |                  |
|  | Phone number (optional)                |                  |
| About solar cooling project  | Project Name                           |                  |
|  | Location of installation               |                  |
|  | Country                                |                  |
|  | Project status                         |                  |
|  | Year of installation                   |                  |
|  | Project classification                 |                  |
|  | Project website                        |                  |
|  | Application sector                     |                  |
| Please include more info about the project which might be relevant for Subtask B. For e.g. What is the overall aim of the project ? What do you expect to achieve. |  |                  |



## 2. Load and Back up



### 2.1 Cooling load

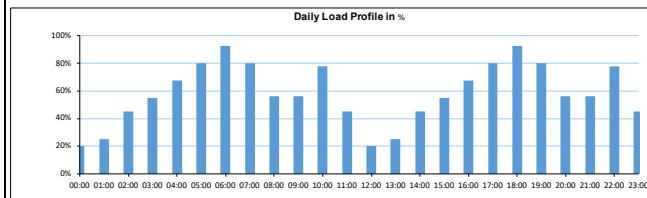
| Info on cooling load   |  | Remarks (if any)            |
|--|--|-----------------------------|
| Conditioned Area (m <sup>2</sup> )                                       |  | In case of HVAC application |
| Cooling Season (Duration/months)   |  |                             |
| Heating season (Duration/months)   |  |                             |
| Peak cooling load (kW)   |  |                             |
| Peak heating load (kW)   |  |                             |
| Designed cooling temperature °C  |  |                             |
| HVAC distribution system   |  |                             |
| Designed heating temperature °C  |  |                             |
| Please include any additional info on cooling load relevant for Subtask. |  |                             |

### 2.2 Back up system and integration

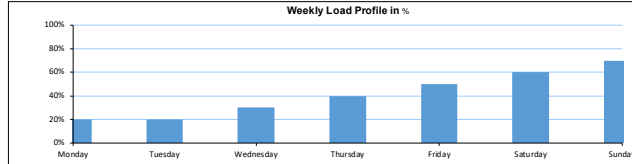
| Information on Backup cooling system (non solar)  |  | Remarks (if any) |
|---|--|------------------|
| Back up system available (YES/NO) ?   |  |                  |
| What is the type of back up used when no heat/power is available from solar field (Electrical heater/Compression chiller/Waste heat for thermal chiller/boiler CHP ?) |  |                  |
| Type of fuel used by Back up system (Electricity/Heat ?)  |  |                  |
| Fuel price for back up system (Euro/MWh etc. .)   |  |                  |
| Back up system efficiency/COP   |  |                  |
| Manufacturer/Product description/website for back up system equipment   |  |                  |
| Please include detailed info on how the back up system is integrated with its overall cooling system design, and how it is controlled to meet the cooling demand      |  |                  |

### 2.3 Cooling load profile

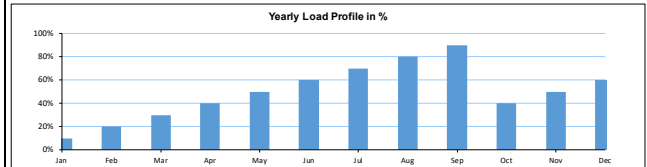
The following inputs will help to determine how the cooling load varies thru out the day/week/month/Year. The load profile can be filled as a percentage of the peak cooling load in Yellow marked cells



| Input the load data here |           |       |           |
|--------------------------|-----------|-------|-----------|
| Time                     | Load in % | Time  | Load in % |
| 00:00                    | 20%       | 12:00 | 20%       |
| 01:00                    | 25%       | 13:00 | 25%       |
| 02:00                    | 45%       | 14:00 | 45%       |
| 03:00                    | 55%       | 15:00 | 55%       |
| 04:00                    | 68%       | 16:00 | 68%       |
| 05:00                    | 80%       | 17:00 | 80%       |
| 06:00                    | 90%       | 18:00 | 90%       |
| 07:00                    | 80%       | 19:00 | 80%       |
| 08:00                    | 56%       | 20:00 | 56%       |
| 09:00                    | 56%       | 21:00 | 56%       |
| 10:00                    | 78%       | 22:00 | 78%       |
| 11:00                    | 45%       | 23:00 | 45%       |



| Day       | Load in % |
|-----------|-----------|
| Monday    | 20%       |
| Tuesday   | 30%       |
| Wednesday | 40%       |
| Thursday  | 40%       |
| Friday    | 50%       |
| Saturday  | 60%       |
| Sunday    | 70%       |



| Month | Load in % |
|-------|-----------|
| Jan   | 10%       |
| Feb   | 20%       |
| Mar   | 30%       |
| Apr   | 40%       |
| May   | 50%       |
| Jun   | 60%       |
| Jul   | 70%       |
| Aug   | 80%       |
| Sep   | 90%       |
| Oct   | 40%       |
| Nov   | 50%       |
| Dec   | 60%       |

### 3. Solar cooling system (1)



#### Information collection on Solar cooling system

Please write general description of the system. What are the technical novelties of the implemented solar cooling system? If possible, Please add any document such as detailed project report/Academic paper which include more details on the system working and components.

#### 3.1 Solar collectors field

|                       |   | Remarks (if any) |
|-----------------------|---|------------------|
| Solar collector field | Solar collector type  |                  |
|                       | Collector tracking?   |                  |
|                       | Working media in solar field  |                  |
|                       | Collector tilt and orientation  |                  |
|                       | Solar collector field area (m <sup>2</sup> )  |                  |
|                       | Collector installation type   |                  |
|                       | Solar field designed capacity (kW the)  |                  |
|                       | Solar collector manufacturer, and model type  |                  |
|                       | Collector rated efficiency at operational temperature   |                  |
|                       | Designed temperature of the solar field (°C)  |                  |
|                       | Layout for solar collector field (no's of collectors rows in Series and parallel)   |                  |
|                       | Flow rate and control (how the temperature from the field is controlled? And what is the specific flow rate in the solar field) |                  |
|                       | How the stagnation in the solar field is managed?   |                  |
|                       | Additional comments on collector design basis   |                  |
|                       | Annual expected thermal Output from solar field (MWh/Year)  |                  |

#### 3.2 Storage

|                        |  | Remarks (if any) |
|------------------------|--|------------------|
| Thermal storage design | Thermal storage implemented in the project (Yes/No)                              |                  |
|                        | Storage for heating/cooling/electricity?   |                  |
|                        | Storage volume (m <sup>3</sup> )   |                  |
|                        | Nos of storage tanks and volume per tank   |                  |
|                        | Storage media (Water/oil/PCM/Thermochemical/electrical)                          |                  |
|                        | Storage designed temperature (°C)  |                  |
|                        | Storage pressure (bar/g)   |                  |
|                        | Storage is stratified or uniformly heated?                                       |                  |
|                        | More info on stratification strategy   |                  |
|                        | Type of heat exchanging element used for Interaction of storage with solar field |                  |
|                        | Heat exchanger type and capacity   |                  |
|                        | Energy stored by the storage (MWh/Year)  |                  |
|                        | Energy storage density for implemented storage (MWh/m <sup>3</sup> )             |                  |
|                        | Insulation type and thickness  |                  |
|                        | Estimated/Measured Heat losses in the storage (kWh/m <sup>2</sup> )              |                  |
|                        | Additional comments on storage design basis                                      |                  |

#### 3.3 Chiller design

|                |   | Remarks (if any) |
|----------------|---|------------------|
| Chiller design | Chiller type used in the project (Thermal/Electrical)   |                  |
|                | Typology of chiller (Absorption/Adsorption)   |                  |
|                | Nos of effects in case of thermal chiller (Single/double/Triple)  |                  |
|                | Info on Chiller manufacturer/model number/website   |                  |
|                | Refrigerant pair (Water+LiBr, Water+NH <sub>3</sub> , Refrigerant type in case of compression chiller etc.) |                  |
|                | Designed chiller cooling capacity (kW)  |                  |
|                | Designed inlet/outlet temp from Heat source to Chiller (°C)   |                  |
|                | Designed Pressure from Heat source to Chiller (°C)  |                  |
|                | Heat carrying medium from heat source to Chiller (Pressurised water/Steam/Hot water/hot air)                |                  |
|                | Minimum temperature threshold level for chiller to operate  |                  |
|                | Designed chilled water inlet/Outlet temp from chiller (Evaporator side)                                     |                  |
|                | Designed cooling water inlet/Outlet temp from chiller (Generator/Condenser side)                            |                  |
|                | Chiller weight, and approximate dimension   |                  |
|                | Any information on the part load operation of chiller   |                  |
|                | Designed Electrical power of the chiller kW   |                  |
|                | Additional comments on Chiller design basis   |                  |

### 3. Solar cooling system (2)

|                                  |   |                         |
|----------------------------------|---|-------------------------|
|                                  |   |                         |
|                                  | Any special designed considered for potential safety hazard from Chillers ?   |                         |
|                                  | If possible, please add Performance map/data for chiller as appendix  |                         |
| <b>3.4 Heat rejection system</b> |   |                         |
|                                  |   | <i>Remarks (if any)</i> |
| Re-Cooling/Heat rejection system | Type of heat rejection system (Dry/wet)   |                         |
|                                  | Design re-cooling temperature °C  |                         |
|                                  | Capacity of heat rejection system (kW th)   |                         |
|                                  | Parasitic power of system components (kW el)  |                         |
|                                  | Manufacturer/model/product No for heat rejection system components  |                         |
|                                  | Any water treatment system installed for operation of heat rejection system ?   |                         |
|                                  | Please add any additional detail for heat rejection system  |                         |
| <b>3.5 Control strategy</b>      |   |                         |
|                                  | Please include details about how the control strategy for solar loop, Back up loop, Chiller loop works. What are the types of controls used ? What are the start/stop criteria for different components of the system ? |                         |
| <b>3.6 System performance</b>    |   |                         |
|                                  |   | <i>Remarks (if any)</i> |
| System performance indices       | Cooling delivered by Solar driven cooling system (MWh/year)   |                         |
|                                  | Heating delivered by Solar driven system (MWh/year)   |                         |
|                                  | Seasonal COP of chiller   |                         |
|                                  | Solar fraction (Cooling)  |                         |
|                                  | Annual efficiency of Solar collector  |                         |
| <b>3.7 Additional info</b>       |   |                         |
|                                  |   | <i>Remarks (if any)</i> |
| Other info                       | How much time did it take for project completion ?  |                         |
|                                  | Please share any installation/operational issues faced during project lifetime  |                         |
|                                  | How satisfy are you (or your customer) with solar cooling system performance (Points out of 5, 5=Very happy, 1= not happy at all)   |                         |
|                                  | Please include any other information which can be useful for Subtask B  |                         |

## 4. Appendix



*If possible, please include the following as appendices*

1. Solar collector data sheet
2. Backup chiller/boiler data sheet
3. **Chiller performance map/data sheet**
4. Storage tank specs/data sheet
5. P&ID (Process and instrumentation diagram) of complete system
6. Any performance data of system
7. Plant photos showing various components of the system