



IEA
SOLAR R&D

INTERNATIONAL ENERGY AGENCY

solar heating and
cooling programme

task VII

**central solar heating
plants with seasonal
storage**

**preliminary designs
for ten countries**

January 1984

INTRODUCTION TO THE INTERNATIONAL ENERGY AGENCY AND THE IEA SOLAR HEATING AND COOLING PROGRAMME

The International Energy Agency was formed in November 1974 to establish cooperation among a number of industrialized countries in the vital area of energy policy. It is an autonomous body within the framework of the Organization for Economic Cooperation and Development (OECD). Twenty-one countries are presently members, with the Commission of the European Communities also participating in the work of the IEA under a special arrangement.

One element of the IEA's programme involves cooperation in the research and development of alternative energy resources in order to reduce excessive dependence on oil. A number of new and improved energy technologies which have the potential of making significant contributions to global energy needs were identified for collaborative efforts. The IEA Committee on Energy Research and Development (CRD), supported by a small Secretariat staff, is the focus of IEA RD&D activities. Four Working Parties (in Conservation, Fossil Fuels, Renewable Energy, and Fusion) are charged with identifying new areas for cooperation and advising the CRD on policy matters in their respective technology areas.

Solar Heating and Cooling was one of the technologies selected for joint activities. During 1976-77, specific projects were identified in key areas of this field and a formal Implementing Agreement drawn up. The Agreement covers the obligations and rights of the Participants and outlines the scope of each project or "task" in annexes to the document. There are now eighteen signatories to the Agreement:

| | |
|---|----------------|
| Australia | Italy |
| Austria | Japan |
| Belgium | Netherlands |
| Canada | New Zealand |
| Denmark | Norway |
| Commission of the European Communities | Spain |
| Federal Republic of Germany | Sweden |
| Greece | Switzerland |
| | United Kingdom |
| | United States |

The overall programme is managed by an Executive Committee, while the management of the individual tasks is the responsibility of Operating Agents. The tasks of the IEA Solar Heating and Cooling Programme, their respective Operating Agents, and current status (ongoing or completed) are as follows:

- Task I Investigation of the Performance of Solar Heating and Cooling Systems – Technical University of Denmark (Completed).
- Task II Coordination of Research and Development on Solar Heating and Cooling – Solar Research Laboratory – GIRIN, Japan (Completed).
- Task III Performance Testing of Solar Collectors – University College, Cardiff, U.K. (Ongoing)
- Task IV Development of an Insolation Handbook and Instrument Package – U.S. Department of Energy (Completed).
- Task V Use of Existing Meteorological Information for Solar Energy Application – Swedish Meteorological and Hydrological Institute (Completed).
- Task IV Performance of Solar Heating, Cooling, and Hot Water Systems Using Evacuated Collectors – U.S. Department of Energy (Ongoing).
- Task VII Central Solar Heating Plants with Seasonal Storage – Swedish Council for Building Research (Ongoing).

- Task VIII Passive and Hybrid Solar Low Energy Buildings – U.S. Department of Energy (Ongoing).
- Task IX Solar Radiation and Pyranometry Studies – Canadian Atmospheric Environment Service (Ongoing).
- Task X Materials Research & Testing – Solar Research Laboratory, GIRIN, Japan (Ongoing).

Task VII – Central Solar Heating Plants with Seasonal Storage: Feasibility Study and Design

Task Objective

In colder climates solar energy for heating of buildings is least abundant when it is needed most – during the winter. A seasonal storage is needed for making solar heat gained during warmer months available for later use. From investigations of various storage methods two observations can be made: The choice of storage method will greatly influence the working conditions for and the optimal choice of the solar collectors and the heat distribution system; and based on the technique that is available to-day the most economic solutions will be found in large applications.

The objectives of Task VII of the IEA Solar Heating and Cooling Programme are to determine the technical feasibility and cost effectiveness of large-scale, seasonal storage solar energy systems for the heating of buildings; to evaluate the merits of alternative large-scale system designs for collecting, storing and using solar energy; and to prepare detailed system designs for specific site parameters.

In the first phase of the Task, which was finished in June 1983, the initial emphasis was on the development and collection of design data, followed by presentation of preliminary designs by each Participant. The Phase I subtasks and lead countries were as follows:

- Subtask I (a) – System Studies and Optimization (Canada)
- Subtask I (b) – Solar Collector Subsystems (USA)
- Subtask I (c) – Heat Storage (Switzerland)
- Subtask I (d) – Heat Distribution System (Sweden)
- Subtask I (e) – Preliminary Design Study (Sweden)

Phase I has immediately been followed by Phase II, which is scheduled to end December 1985. The purpose of Phase II has been redefined, with a consequent revision of the Annex Agreement, as follows:

- to compare simulation results from the MINSUN program, which was developed during Phase I, with other similar or more detailed tools
- to examine a wide range of system configurations, operational strategies and load/location characteristics
- to recommend which configurations deserve further attention for specific applications, and which configurations are economically least attractive
- to enhance the MINSUN program to cover a wide range of configurations
- to prepare for a further cooperative use of data from existing plants to validate the design data from Phase I and II, and to evaluate components, systems, control strategies, etc.

The work in Phase II is organized in three subtasks as follows:

- Subtask II (a) – MINSUN Enhancement and Support (Canada)
- Subtask II (b) – Evaluation of System Concepts (USA)
- Subtask II (c) – Exchange of detailed Engineering Data and Experience with CSHPSS-systems (Netherlands)

This report documents work carried out under Subtask I (e) of this Task.

central solar heating plants with seasonal storage

preliminary designs for ten countries

Arne Boysen
Bengt Hidemark Gösta Danielson Ark. HB, Sweden January 1984

This report is part of the work within the IEA Solar Heating and Cooling Programme
Task VII: Central Solar Heating Plants with Seasonal Storage
Subtask I(e): Preliminary Design Study (Sweden)

D12:1985

ISBN 91-540-4371-9

Swedish Council for Building Research, Stockholm, Sweden

Printed in Sweden, 1985

TABLE OF CONTENTS

| | | |
|----|--|----|
| 1. | INTRODUCTION | 5 |
| 2. | ACCOMPLISHMENTS IN PHASE I OF TASK VII | 7 |
| 3. | AN OVERVIEW OF THE 10 NATIONAL DESIGNS | 15 |
| 4. | WORK IN PHASE II OF TASK VII | 21 |
| 5. | DESIGN SUMMARIES | 23 |
| | 1. AUSTRIA | 27 |
| | 2. CANADA | 29 |
| | 3. CEC | 31 |
| | 4. DENMARK | 33 |
| | 5. FRG | 35 |
| | 6. NETHERLANDS | 37 |
| | 7. SWEDEN | 39 |
| | 8. SWITZERLAND | 41 |
| | 9. U.K. | 43 |
| | 10. U.S.A. | 45 |

APPENDICES

| | | |
|----|-------------------------------|----|
| 1. | References | 47 |
| 2. | List of participating experts | 51 |

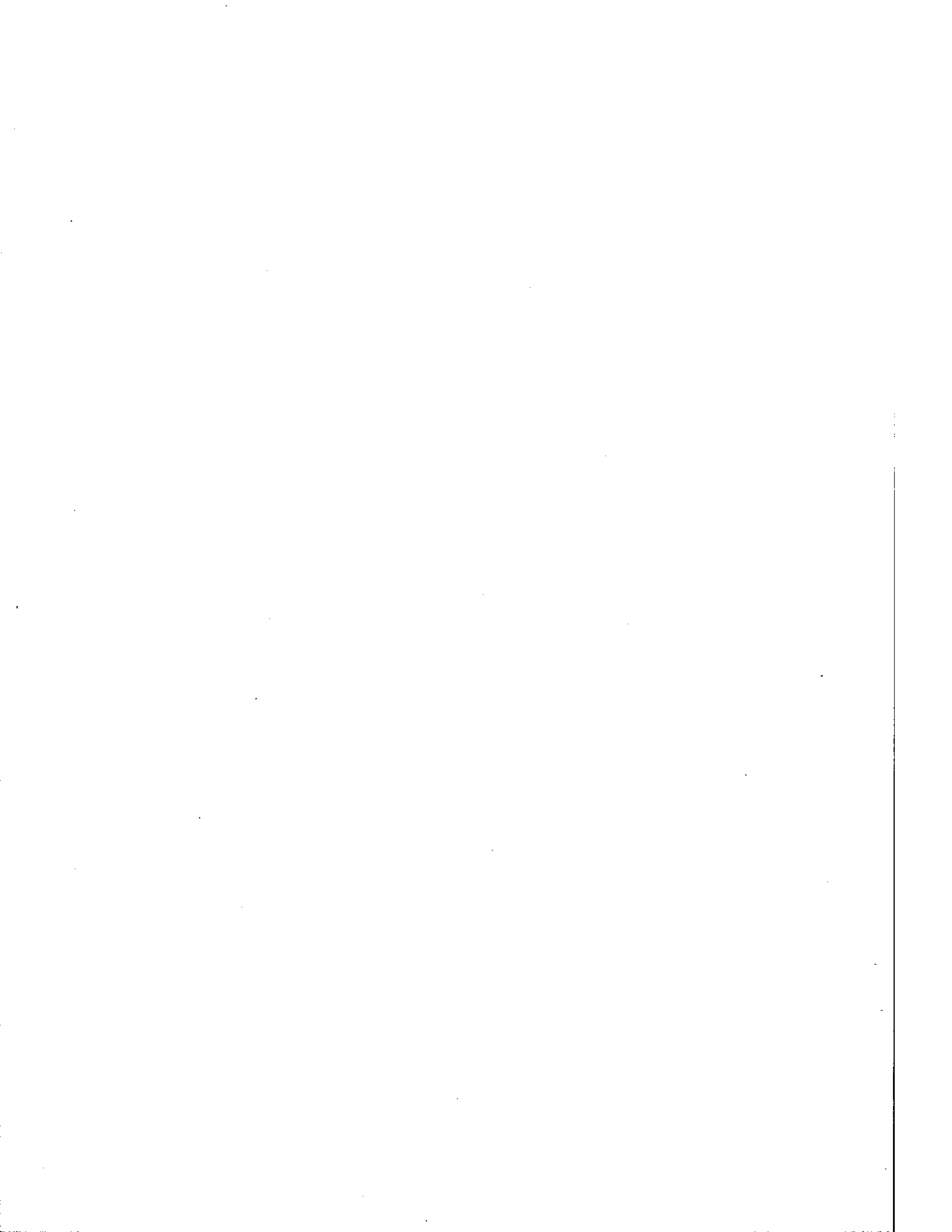

1. INTRODUCTION

When Task VII was started in 1979 the aim was to produce a number of designs for solar heating plants with seasonal storage. These designs were to be based on the latest information from research, and it was expected that the documentation of this design basis would create the major effort during the first phase of work. A list of the reports resulting from this work is to be found in chapter 2, page 16. The design work proper was planned to be taken in two steps. In the first step preliminary site specific designs were to be developed by each country, this step being the conclusion of Phase I, and in the second step, which also was thought of as the Phase II of the Task, the preliminary designs were to be developed into detailed designs. It was expected that the level of detail would be sufficient for decisions to be taken to proceed with construction, if any country was prepared to go that far.

In reality it was not possible to follow the original straightforward plan of work, in which the collection of a design basis was to be followed by a preliminary design, which eventually was leading to a detailed design. It was found that the R & D on the fundamental major parts of a solar heating system with seasonal storage was still in a very dynamic phase and not yet yielding definitive conclusions and design recommendations. The subtask of bringing the design basis together and documenting it for future use became part of the proper R & D efforts in the participating countries. This had the effect that the preliminary designs in most cases were not directly based on the final reports from subtasks I(a) - I(d), but on the knowledge and experience that was available within each of the countries at the time. The work on Task VII had of course contributed to this knowledge, but it is impossible to say to what extent.

This report is a summary documentation of the preliminary designs from the 10 participating countries, more detailed information being available in national reports. The documentation follows a format, which was developed by the participants as an adaption of the IEA reporting format for thermal performance of solar heating and cooling systems in buildings (from Task I).

A development of the original plans for the Task is the fact that some countries actually built systems for solar heating with seasonal storage already during the first Phase of Task VII. In those cases the documentation covers these systems and has a greater realism than originally anticipated.

This report will present an overview of the national designs. First, however, an overview of the total work on Task VII will be given.

There were ten Participants in Phase I: Austria, Canada, the Commission of the European Communities (CEC), Denmark, Federal Republic of Germany, the Netherlands, Sweden, Switzerland, United Kingdom and the United States. The experts representing these Participants are listed in Appendix 2. Operating Agent for the whole Task, and also Lead Country for subtask I(e), is the Swedish Council for Building Research. The actual work has been carried out by the author of this report, Mr. Arne Boysen, working on contract for the Council. Professor Edward Dean, on sabbatical leave from the University of California, has assisted in developing the format for this report, and in editing the information from the participating countries.

2. ACCOMPLISHMENTS IN PHASE I OF TASK VII

For northern countries the amount of solar energy per annum is about the same as for countries much further south - but it is very unevenly distributed over the year. Very little energy during the winter, very much during summer. Storage of a seasonal capacity becomes necessary if solar energy is to substitute the use of fuel for space heating. Even so, some auxiliary energy has to be supplied, be it power to a heat pump or fuel to a boiler. These are therefore the main parts of a system (Figure 1).

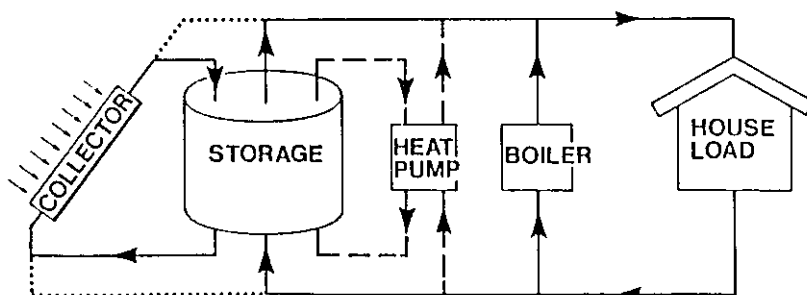

Figure 1.

Main parts
of a Central Solar Heating Plant with a Seasonal Storage.
(Note that alternative schemes are possible).

Participants in this project decided at the start to focus the study on systems where energy is stored as sensible heat and distributed as hot water. With these conditions it becomes necessary to have very large storage volumes in order to keep the relative heat losses down. These large volumes have to be combined with large loads - in most cases large number of houses. This concept is indicated by the title of the project - TASK VII - Central Solar Heating Plants with Seasonal Storage, or CSHPSS.

Heat distribution subsystem

In such a system the heat distribution uses the same technique as in a district heating system. Several of the participating countries have long experience in this area, and this was summarized in a short report giving engineering data, cost information and overviews of codes and state-of-the-art in the ten countries (1). The interest for such heat distribution is growing, and even countries like U.S.A. and Canada, where steam is the conventional distribution medium, reported that demonstration projects are underway using what perhaps might be called a European hot-water technique.

In CSHPSS-projects the conditions for the two distribution loops are not the same as in district heating systems. In the collector/storage loop the total or close to the total annual energy consumption has to be collected during sunshine hours in about half of the year - which means high peaks and short utilization periods. This favours a concentrated collector field and location of the storage close to the collectors.

In the storage/load loop the return temperatures are normally quite low in order to utilize the storage capacity.

Also in countries with long experience of conventional district heating the solar energy application introduces new factors and necessitates a new interest for developing tools for a very careful design, reducing the installation cost, maintenance, and heat losses for the heat distribution.

Heat storage subsystem

The heat storage technique is the key to the problem of the CSHPSS-systems. Seasonal storage means basically that the utilization factor is low, and extremely cost-effective storage concepts must be found. The current R & D is attacking this problem along many lines, testing and evaluating many different concepts. In Task VII six storage alternatives were selected for investigation: Pit, Tank, Cavern, Aquifer, Earth and Rock. For each of these approaches demonstration projects were identified, the state-of-the-art was summarized, and engineering data and cost information was collected.

For pit storage the waterproof liner is of paramount importance. It must retain the watertightness and strength for many years at elevated temperatures. A maximum temperature of 70-80°C is being recommended. The storage normally has a high surface/volume ratio and insulation becomes necessary to keep the heat losses down. The best geological conditions for building a pit store are easily excavated, stable soil, free of ground water.

Tank storage can be considered as a well-known technique. It can be used almost everywhere, has low heat losses and is very flexible in operation. Structural reasons may limit each tank to an approx volume of 100.000 m³, and a maximum height of approx 13 m, but several tanks may be used. FRG has reported a feasibility study of a steel-membrane reservoir for which there is in practice no restriction in size.

Storage in rock caverns is another example of an established technique being applied in a new area. In crystalline rock, large caverns can easily be excavated. Blockfilled caverns have been suggested to reduce the demands on the stability of the mass. The caverns are built without heat-insulating liners, and the surrounding rock participates in the temperature variations. Considerable amounts of heat are needed during the first years to warm up this mass, but then the heat losses are stabilized at a rather low annual level.

Aquifer storage of heat has been demonstrated successfully, but a number of problems still need to be solved. One great advantage of the aquifer storage is that the stored water also is the transfer medium. Thus, the thermal disturbance can be controlled more simply, and large peak loads can be injected or withdrawn compared with earth or rock storage systems.

An earth storage is in principle a layer of subsoil with a heat exchanger in it. At the top, and sometimes around the perimeter, there is an insulation. The heat exchanger is formed by tubes in most cases, vertically or horizontally. Ideally, the earth should be saturated, but high permeability and ground water movements can cause high heat losses. A vertical screen around the storage can limit these losses. Storage temperature is normally low - there is very limited experience for temperatures higher than 40°C.

Rock storage is similar to earth storage with vertical tubes. The heat carrying fluid, normally water, can be circulated through bore-holes in the rock - wells - in open or closed circulation systems. Heat is stored in the rock mass which is perforated by the wells, and buffer storage may be used to reduce peak loads. Deep wells allow storage temperatures above 100°C. Construction of a rock storage utilizes well-known drilling technique.

General engineering data and cost information has been supplied by the participating countries, which also supplied detailed data from 31 projects (Table I) (2), (3).

Table I Storage projects reported from each country

| | Tank | Pit | Cavern | Aquifer | Earth | Rock | Sum |
|-------------|------|-----|--------|---------|-------|------|-----|
| Austria | | | | | 1 | | 1 |
| Canada | 2 | | | 1 | | | 3 |
| CEC | 1 | | | | 1 | | 2 |
| Denmark | | | | | | | - |
| FRG | | 3 | | 1 | | | 4 |
| Netherlands | | | | | 1 | | 1 |
| Sweden | 4 | 1 | 3 | 2 | 3 | 3 | 16 |
| Switzerland | | | | 1 | 1 | | 2 |
| U.K. | | 1 | | | | | 1 |
| U.S.A. | | | | 1 | | | 1 |
| Sum: | 7 | 5 | 3 | 6 | 7 | 3 | 31 |

The proper design of a heat storage has to be based upon simulations. Simulation models were collected, tested and evaluated.

Three main families of models were considered, namely one for water tank, pit and cavern storage systems, one for earth and rock storage systems, and finally one for aquifer systems. Of the first family, 7 models were investigated, of the second, 8 models, and of aquifer models 5, in all 20 different models (Table II). The evaluation led to a selection of three models, all originating from the Lund Institute of Technology (4). Computer codes for these three models are available both in MINSUN - the program developed in Task VII - and TRNSYS.

Table II Evaluated storage models from each country

| | Tank, Pit & Cavern | Aquifer | Earth & Rock | Sum |
|-------------|--------------------|---------|--------------|-----|
| Austria | | | | - |
| Canada | 2 | | 1 | 3 |
| CEC | | | 1 | 1 |
| Denmark | | | | - |
| FRG | | | | - |
| Netherlands | | | 1 | 1 |
| Sweden | 2 | 1 | 2 | 5 |
| Switzerland | | | 1 | 1 |
| U.K. | | | 1 | 1 |
| U.S.A. | 3 | 4 | 1 | 8 |
| Sum: | 7 | 5 | 8 | 20 |

Solar collector subsystem

Design data for the solar collector subsystem were developed in a similar way as the data for heat storage. National data and experience were collected, evaluated and generalized. Types of collectors that are suitable for central heating plant application have been identified; analytical models were developed that predict the performance; the performance of large collector arrays was analyzed; and cost equations were defined.

The report (5) identifies five generic types of collectors: Flat plates, shallow solar ponds, evacuated collectors, parabolic troughs and central receiver.

The performance of flat plate collectors has reached maturity - manufacturers are now more concerned with reducing costs than improving efficiency. No significant gains in efficiency are on the whole likely in the next five years, barring unexpected innovations.

For solar ponds the attention has been focused on shallow ponds, in which the absorber is usually a plastic envelope, blackened on the bottom to absorb the radiation, insulated from the earth and covered with an additional plastic or glass glazing.

Evacuated collectors are still being developed to reach higher efficiency. In Task VII data for high performance CPC collectors have been used, anticipating that values reached in laboratories today soon will be reached in commercially available units.

The parabolic troughs that have been considered, are sun-tracking with an EW orientation. For the performance model a hypothetical collector was selected - having an optical efficiency of 0,807 and heat loss coefficients equal to the 1985 goal at the Sandia National Laboratory, U.S.A. These values were reached in laboratory tests already before 1984.

For central receivers the performance model that is used is based on a theoretical analysis.

As the collectors, regardless of type, have to be arranged in large arrays, much attention has been given to what effect this might have on the performance as compared with a single collector module. Very little information has been found in literature and research reports, so the participants initiated a special workshop on this topic, held in the U.S.A., in June, 1984. Based on the available experience, on analysis, and on judgement certain performance reduction factors were developed and used in Task VII until better data is available.

There are a number of innovative collector concepts that may be viable for central plant applications that were not examined in any depth. The reason being that the participants decided at the start that the technique used in the study should have achieved a certain maturity, which implied that a mass production of components is established, with a corresponding price level for the collectors.

In reality a design has to be based on data for available components rather than generic types. It was therefore suggested that besides using the jointly developed design information, each participant might want to use alternative data, reflecting national experience and components on the market. No such studies have however been reported during the first Phase of the Task.

The MINSUN simulation and optimization program

When the work started, the participants agreed to use the TRNSYS model for simulation of the performance and a Swedish model called MINSUN for optimization. The work has led to some improvements of TRNSYS, but the main work has been done on MINSUN (6), (7). As the work progressed the MINSUN program was further developed to include the five generic collector types that have been mentioned, as well as the six storage concepts, and it can now be used to simulate the thermal behaviour of a central solar energy system as well as determine the optimum size of some of the components. The program can be run in three different modes - Single Simulation, Multiple Simulation and System Optimization.

The simplest application of MINSUN is to perform a Single Simulation for a given, fixed configuration. All parameters of the system are defined by the user. The program simulates the thermal behaviour, does the energy balance and cost calculations, and generates output on the thermal and economic characteristics of the system specified. The thermal characteristics include a daily specification of heat flows among the major subsystems (from collectors, to and from storage, to load, losses, etc.).

In the Multiple Simulation mode MINSUN allows the user to perform several simulations in a single run while systematically varying the parameters defining the system. Only a limited number of result values are kept from each run. This mode is very useful for examining the effects of given input parameters on particular system results. It also uses less computation time than a large number of single simulation runs to get the same outputs.

These multiple runs can be made in two ways. Using the first and simplest of these, the MINSUN set of programs is capable of systematically varying any two (of nine) key design variables and performing single simulations at each point of the grid formed by the two variables. A typical application is to examine system cost as a function of two key variables, say collector area and storage volume. The program automatically spans a specified range for each variable with the requested number of points. Important results such as cost and solar fraction are selected from the simulation results for each grid point and are saved in a separate computer file. These results can then be examined by the user in numeric form or, as intended, plotted using three-dimensional graphics. Then the key results, such as cost or solar fraction, can be examined as a surface over the grid formed by the two variables selected, figure 2.

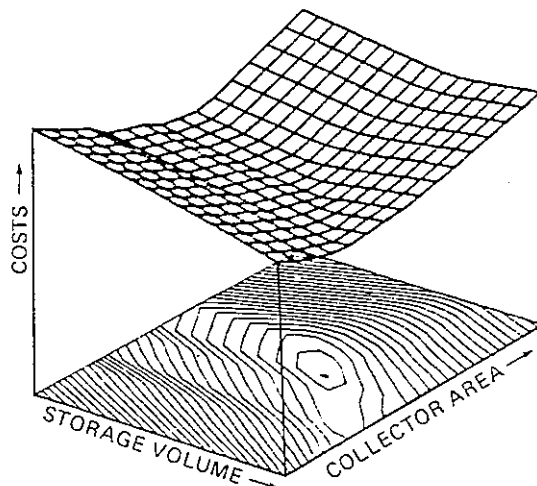

Figure 2. Sample Cost Surface Plot

Annual cost for various combinations of collector area and storage volume.

Note that the MINSUN package only produced the data. The actual plotting must be done by the individual user.

The second Multiple Simulation option, the MINREP procedure, is slightly more complicated, but much more flexible. Single or iterative changes of any system parameters (not just the nine) can be specified. In addition, any results which appear on the detailed Simulation Summary output to a maximum of twelve variables, can be specified for inclusion in the summary output.

In the System Optimization mode the MINSUN set of programs has the capability to automatically select optimum values for key design variables which minimize overall system levelized annual cost. The variables which can be optimized are the same nine which can be varied in the multiple simulation. The program uses a search procedure to vary the values of the appropriate design variables. It then simulates the thermal behaviour and computes the cost of this system, and compares the cost of this system with that calculated in previous iterations. In this way, the program closes in on the values of the design variables which minimize system cost.

The MINSUN set of programs

As indicated in figure 3 there are two separate main programs: the collector model set and the system simulation and optimization model set. The collector model set requires collector system parameters and other parameters to be set by the user. It then takes hourly solar radiation and temperature data and calculates the amount of energy that would be collected by a collector (per unit area) operating at a given temperature on a daily basis. Several operating temperatures are used and all results are stored for later use.

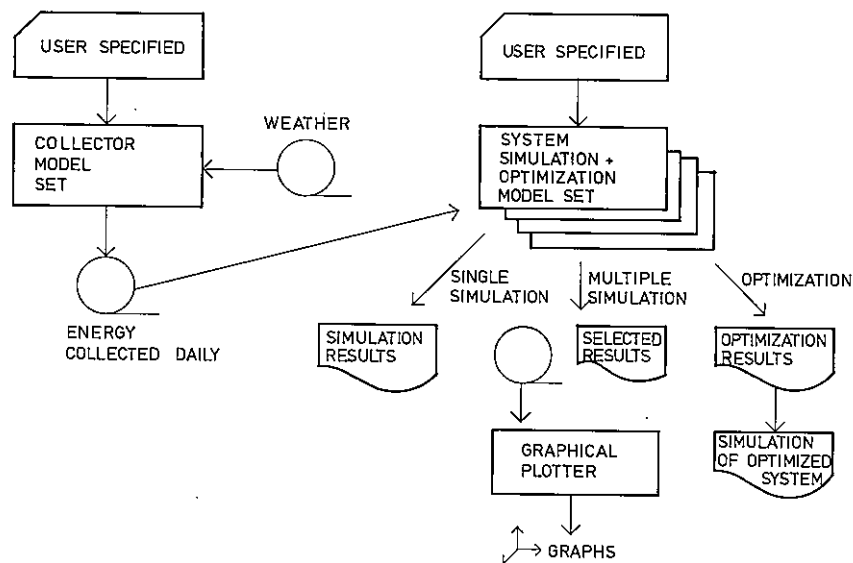

Figure 3. The MINSUN set of programs

The system simulation model requires a large number (approximately 150) of system and other parameters to be specified by the user. It then simulates the thermal performance of a given system on an annual basis. As described above, this system can be applied in one of three modes, for single simulation, for multiple simulation or for optimization. Since the various storage model programs are large, there are separate programs for each storage type as depicted in figure 3.

3. AN OVERVIEW OF THE 10 NATIONAL DESIGNS

The following basic data table shows some basic data on the national designs of CSHPSS-system from each of the ten participating countries. Each is described in detail in national reports. From these reports information has been condensed into two-page summaries for each project, and these summaries follow in chapter 5. The reader is cautioned not to evaluate the designs on the basis of these summaries, which are presented here only as a guide to the complete information in the national reports, Ref. (9) - (20).

The Austrian report describes a project that was designed and constructed while Phase I of Task VII was in progress. The discussions and the work in Task VII probably contributed to the design of the project, but precisely how much is impossible to say.

The Canadian report also presents a project that was designed and under construction at the time for Phase I. The storage - an aquifer - is primarily used for storing cooling water, and a cooling tower is a dominant feature of the system. In this respect the project does not follow the intentions for the Task VII work. A separate aquifer was analyzed for the use of storing heat from either solar collectors or from waste heat recovery from the building, to be used for space heating purposes during the winter. The project may provide interesting practical experience in the future.

The Danish report is a theoretical design. However, the storage concept, an earth pit, is being tested in full scale within the national energy research program, and as the other subsystems are based on well-known technology, the project may be considered to represent a realistic case.

The CEC project is also a theoretical one. The load is a single building - like the Austrian, the Canadian and the Swiss projects - which does not require a heat distribution system as complex as when a large number of buildings are being served.

The project from FRG is based on an existing site with houses for one or two families. The CSHPSS-system is a theoretical design, supplying heat for space-heating only. Only 23 houses on the site are considered to be connected to the CSHPSS-system, which makes it difficult to design a system with a potential good economy.

In the Netherlands a system has been built for a group of 96 houses. At one point of time it was the intention to test the performance of the system by simulating the solar heat delivered to the storage. Finally, however, it was possible to finance the complete system, which was put in operation during 1984.

The Swedish presentation is based on a detailed design that was intended to be constructed. At a very late stage the demand for new dwellings in that particular area was drastically reduced, and the project was therefore never realized. The design, however, was based on realistic conditions and on operational experience from several smaller, full-scale testing plants. Of

the ten projects this is the only one that approaches a second generation state-of-the-art.

The Swiss project was in most details already designed when the work in Task VII was started. The construction was however delayed in order to utilize the IEA work on design of heat storage. The load is far from being representative of dwellings, and no DHW is being produced.

The U.K. project is purely theoretical, and very much designed to meet the load recommendations that were accepted by all Participants at the start of the IEA work. The design is made for a group of 100 houses, which provides a realistic basis for demonstration of technical features and problems, but is too small to provide the best economy.

The US project, which also is rather small, presents an idea of utilizing existing underground storage tanks in an area undergoing a major redevelopment. The project is therefore characterized by a number of constraints which do not exist in the other nine projects. It is economically favoured by the use of existing storage tanks and tunnels for the piping, which leads to a cost for solar energy which is competitive with conventional heating means.

At the start of the work in Task VII the Participants agreed to aim at hydronic systems with a solar fraction of 80 % or more. This solar fraction was suggested in order to assure designs which made use of considerable storage capacity, and the fraction 80 % does not necessarily present an economic optimum. This question is now studied more closely in Phase II of the Task.

Heat pumps are being used in seven of the ten designs, in a number of different ways. Also, the use of buffer storage varies. The variation in the choice of solar collectors is in comparison much less. Most striking is the different selection of storage concepts. This may indicate that heat storage is the area that is least well-known.

The overview, although limited to a few basic data, shows how the concept of solar heating utilizing seasonal storage may be varied to suit the local conditions. It is difficult to make general evaluations of such an adaptable technique, and judge the general feasibility in the participating countries.

One tool for an optimized design and the feasibility study is the MINSUN program. This was not ready to be used for such purposes when the ten national designs were made, and it is therefore probable that the designs can be improved. An evaluation based upon this material only is not likely to lead to the right conclusions.

Another difficulty is the lack of a common methodology for cost analysis. Problems and factors to take into account in life cycle cost calculations were discussed during Phase I, Ref. 8. but it was not possible to reach an agreement on how the economics for a project was to be calculated, presented and compared with others.

AUSTRIA

INNSBRUCK-KRANEBITTEN

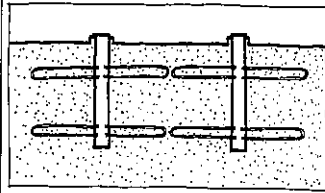

HORIZONTAL EARTH COIL

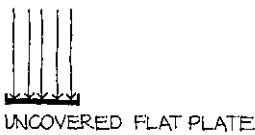
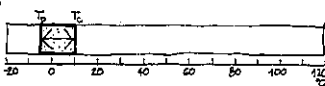

UNCOVERED FLAT PLATE

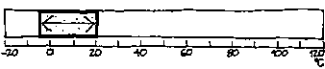

CENTRALIZED/BUILDINGS

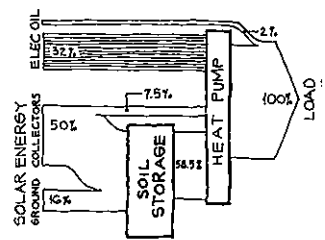
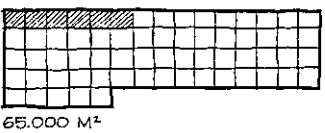
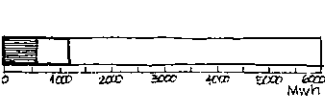
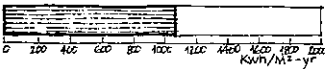
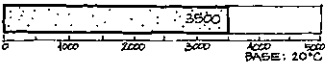
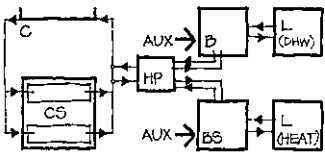

CANADA

SCARBOROUGH CSHPS STUDY

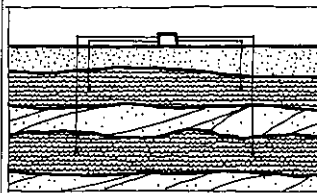

CONFINED AQUIFERS

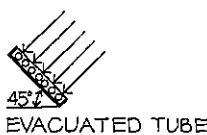
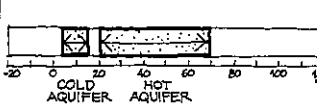

EVACUATED TUBE



CENTRALIZED/BUILDING

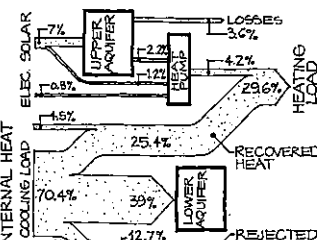
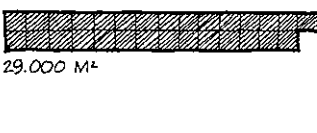
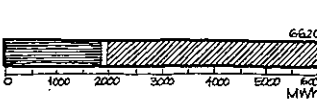
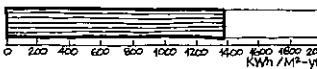
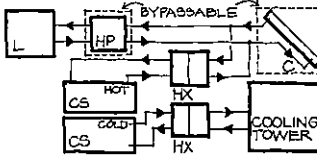

DENMARK

HJORTEKAER

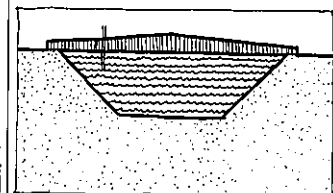

EARTH PIT

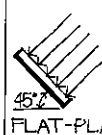
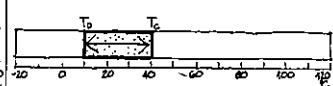

FLAT-PLATE w SELEC. SURF.

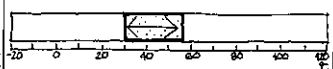
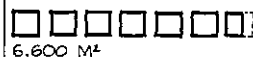

CENTRALIZED/BUILDINGS

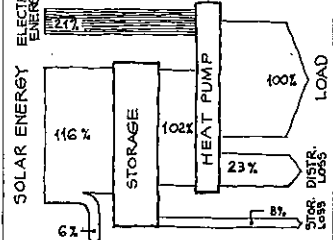
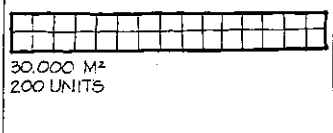
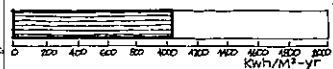
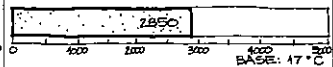
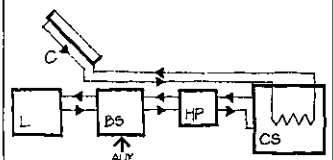

- PROJECT
- STORAGE SUBSYSTEM

- TYPE
- SIZE
 - 10,000 M³
 - 100,000 M³
- TEMPERATURE (VOL. AVG.)
 - T_C - WHEN FULLY CHARGED
 - T_D - WHEN FULLY DISCHARGED

- COLLECTOR SUBSYSTEM
- TYPE
- SIZE
 - 1000 SQ. M.
- TEMPERATURE (OPERATING RANGE)

- LOCATION
- SYSTEM CONCEPT
 - CS - CENTRAL STORAGE
 - BS - BUFFER STORAGE (DIURNAL)
 - HP - HEAT PUMP
 - C - SOLAR COLLECTORS
 - L - LOAD
 - AUX - AUXILIARY HEAT SUPPLY
 - B - BOILER
 - HX - HEAT EXCHANGER

- CLIMATE
- DEGREE-DAYS
- SOLAR RADIATION
 - ANNUAL GLOBAL SOLAR ENERGY ON 1 SQ. M. HORIZONTAL SURFACE
- LOAD
- ANNUAL BUILDING DEMAND
 - HEATING
 - COOLING
 - DOMESTIC HOT WATER
- BUILDING FLOOR AREA
 - RESIDENTIAL, 1000 SQ. M.
 - COMMERCIAL, 1000 SQ. M.

- ENERGY FLOW
- PERCENTAGES BASED ON TOTAL BUILDING LOAD = 100 PERCENT

EUROPEAN COMMUNITIES
ISRA CSHPS STUDY

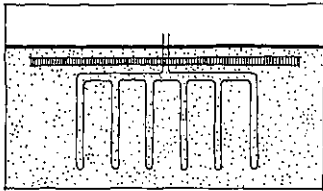

VERTICAL EARTH COIL



90.000 M³

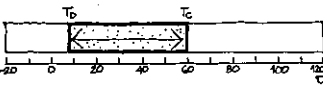

FLAT-PLATE/ROOF INTEGR.

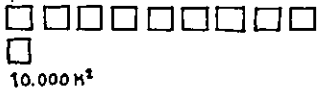

10.000 M²

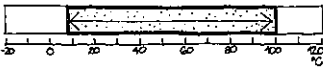

CENTRALIZED/BUILDING

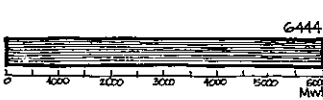
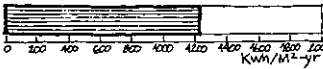
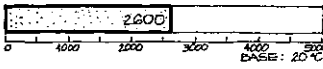
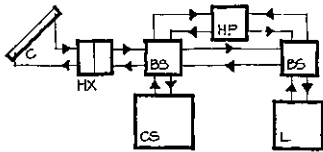

42.000 M³

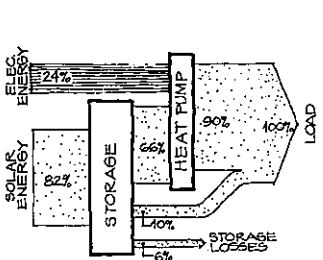

FEDERAL REPUBLIC OF GERMANY
WOLFSBURG-GLOCKENBERG

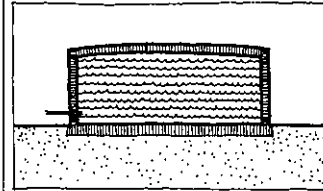

STEEL TANK



3.000 M³

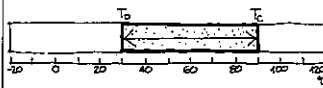

EVACUATED TUBE



800 M²



CENTRALIZED/FIELD

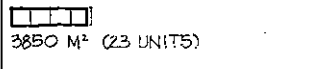
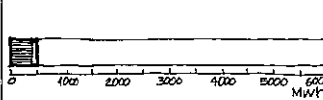
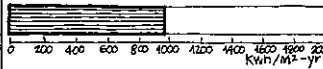
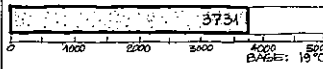
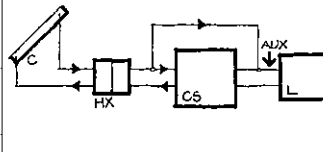

3850 M³ (23 UNITS)

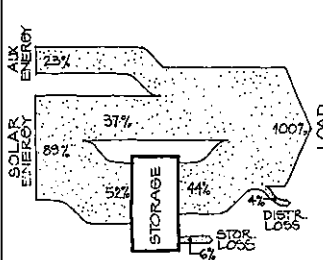

THE NETHERLANDS
GRONINGEN

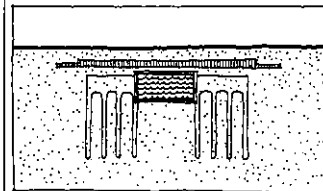

VERTICAL EARTH COIL



23.000 M³

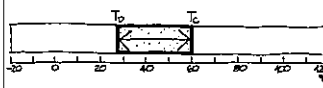

EVACUATED TUBE



2.400 M²



DISTRIBUTED /BUILDINGS

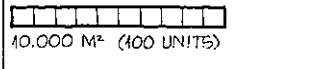
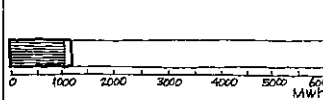
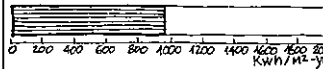
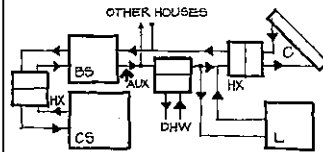

10.000 M³ (100 UNITS)

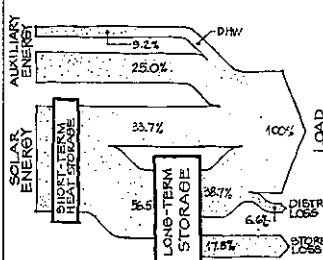

SWEDEN
SÖDERTUNA

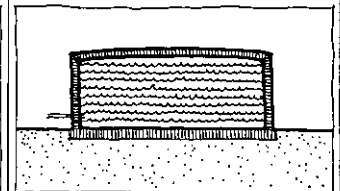

STEEL TANK



55.000 M³

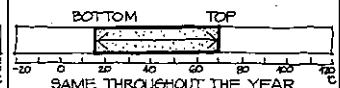

FLAT-PLATE/ROOF INTEGR.

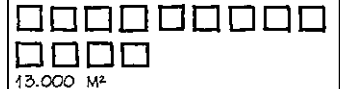

13.000 M²

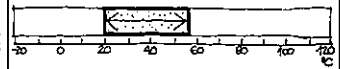

CENTRALIZED/BUILDING

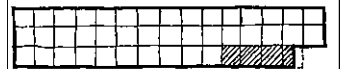
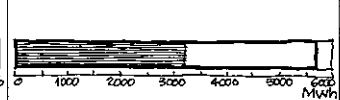
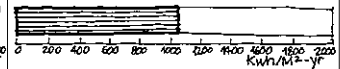
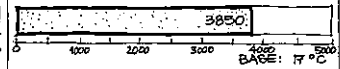
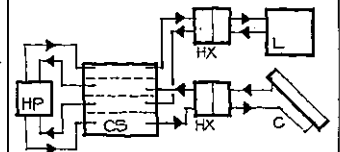

40.000 M³ (525 UNITS)
 3900 M³ COMMERCIAL

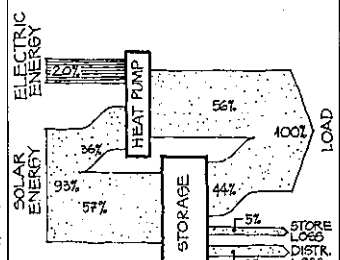

SWITZERLAND

VAULRUZ

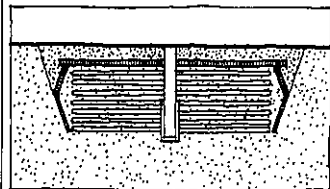

HORIZONTAL EARTH COIL

3,500 M³

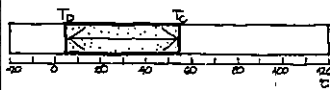

FLAT-PLATE/ROOF INTEGR.

520 M²

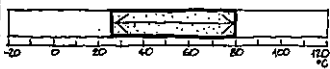

CENTRALIZED/BUILDING

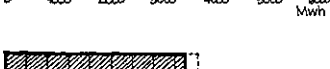
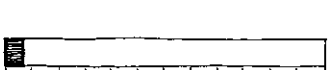
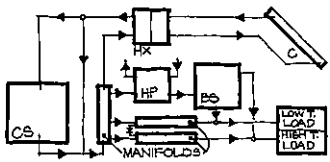

2,300 M²

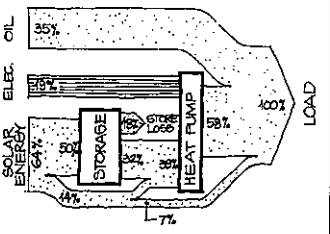

UNITED KINGDOM

U.K. NATIONAL

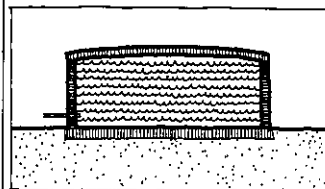

STEEL TANK

7,500 M³

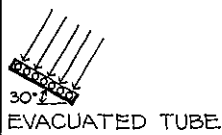
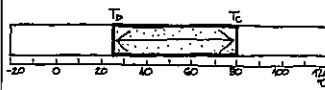

EVACUATED TUBE

3,600 M²

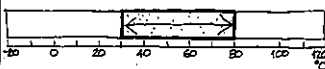

CENTRALIZED/FIELD

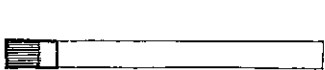
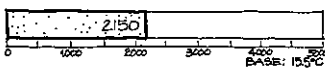
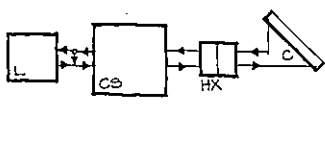

8,000 M²

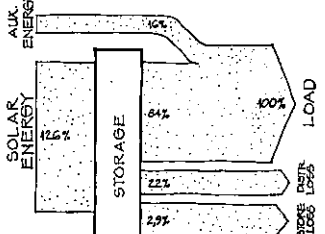

UNITED STATES

CHARLESTOWN

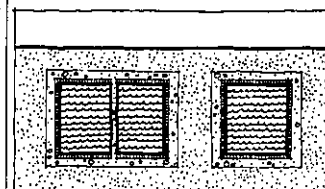

CONCRETE TANKS

5,700 M³



FLAT-PLATE W SELEC. SURF.

2,300 M²



CENTRALIZED/BUILDINGS

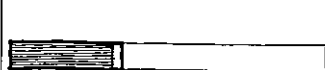
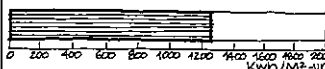
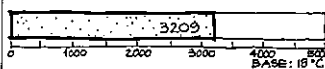
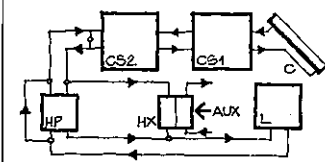

10,500 M²

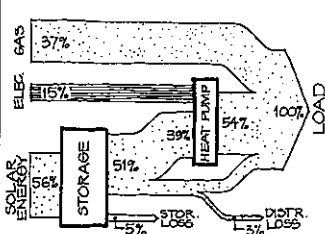

- PROJECT
- STORAGE SUBSYSTEM

- TYPE
- SIZE
 - 10,000 M³
 - 100,000 M³
- TEMPERATURE (VOL. AVG.)
 - T_C - WHEN FULLY CHARGED
 - T_D - WHEN FULLY DISCHARGED

- COLLECTOR SUBSYSTEM

- TYPE
- SIZE
 - 1000 SQ. M.

- TEMPERATURE (OPERATING RANGE)

- LOCATION

- SYSTEM CONCEPT

- CS - CENTRAL STORAGE
- BS - BUFFER STORAGE (DIURNAL)
- HP - HEAT PUMP
- C - SOLAR COLLECTORS
- L - LOAD
- AUX - AUXILIARY HEAT SUPPLY
- B - BOILER
- HX - HEAT EXCHANGER

- CLIMATE
- DEGREE-DAYS

- SOLAR RADIATION
- ANNUAL GLOBAL SOLAR ENERGY ON 1 SQ. M. HORIZONTAL SURFACE

- LOAD
- ANNUAL BUILDING DEMAND

- HEATING
- COOLING
- DOMESTIC HOT WATER

- BUILDING FLOOR AREA
- RESIDENTIAL, 1000 SQ. M.
- COMMERCIAL, 1000 SQ. M.

- ENERGY FLOW
- PERCENTAGES BASED ON TOTAL BUILDING LOAD - 100 PERCENT

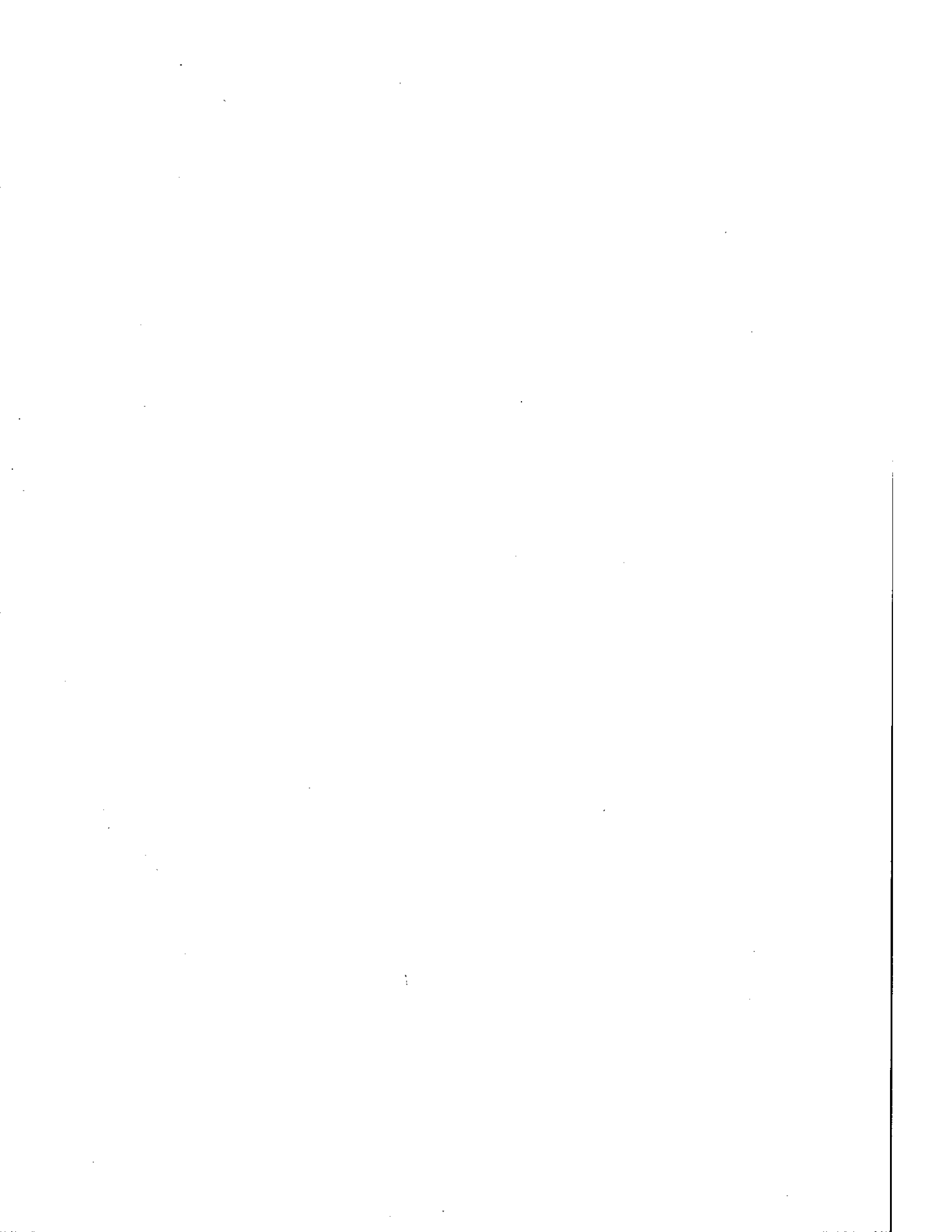

Each participant has therefore used his own methodology when analysing the economics. It is interesting to note how they report their findings. With some simplification they give us the following picture:

| | |
|-------------|--|
| Austria | 8-10 year pay-back |
| Canada | Discouraging economics |
| CEC | 16 year pay-back |
| Denmark | Economically attractive concept |
| FRG | Little economical interest |
| NL | Cost data are still too rough, too uncertain to make any reliable prognoses concerning economics |
| Sweden | Cost-effective system possible |
| Switzerland | 50-70 years pay-back |
| UK | Discouraging economics |
| US | Competitive costs |

As already has been stated the cost-effectiveness of the different concepts in this report can not rightly be judged or compared. To provide at least some kind of an evaluation it was decided to finish Phase I with a discussion of each project, following upon the presentation of the project by the country in question. Two other countries agreed to review the project in advance and to present some comments, which could be taken up and debated.

The time for these reviews was extremely short, the project presentations being handed out 1½ day before the proper start of the meeting. The comments could not under these conditions be more than individual reflections, and the experts decided that they should not be included in this report. Most countries have, however, reported that they found this discussion at the end of Phase I useful, and it will have an impact on the future work in this field.

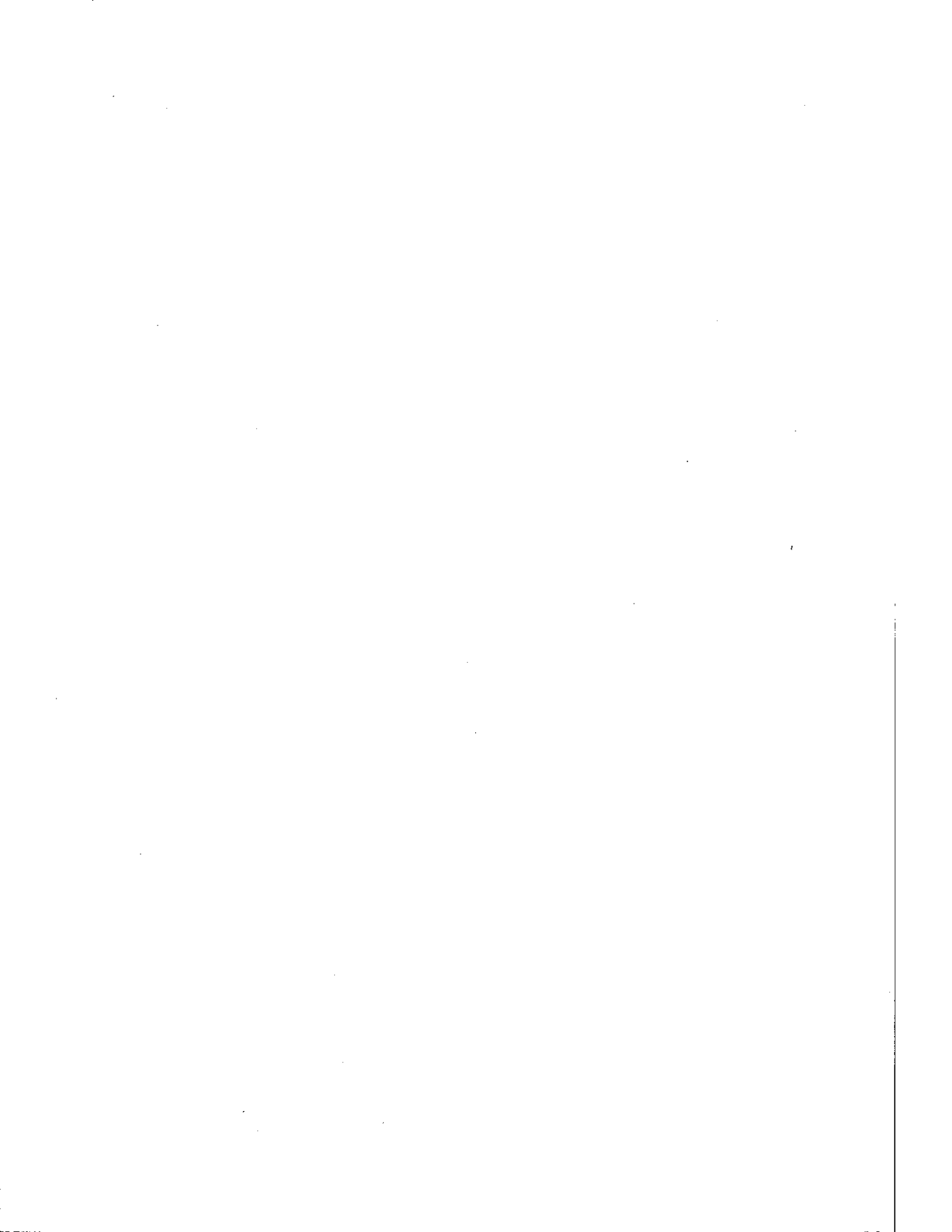

4. WORK IN PHASE II OF TASK VII

However interesting the single projects presented in Phase I may be, they do not give a generally valid indication of the cost-effectiveness of solar heating with seasonal storage. Some technical solutions have been given, but a real feasibility study has to be based on a much greater number of projects. This is therefore one subtask for the Phase II-work.

Another subtask is to prepare for a coordinated and organized exchange of information from existing or new CSHPSS-projects in order to provide data that may be compared and evaluated.

Both of these subtasks will be finished by the end of 1985, and then reported. No details of the work can be given in this report.

The basic tool for the feasibility study is the MINSUN program, which allows vast numbers of project variations to be easily calculated and compared. Areas for optimal combinations of parametric values will be found for a given climate. It has to be realized, however, that studies using the basic information included in the MINSUN program and described in the reports from Phase I may not present the optimal solution for a given site. The MINSUN program has generic technical data and generalized cost information, while a true optimum will be found only by using real data for a certain site and a particular point of time.

To illustrate this point and to find out the differences in results general MINSUN runs will be compared with results using national data from a few countries.

From these studies some general guide-lines for the design of solar heating systems with seasonal storage may emerge.

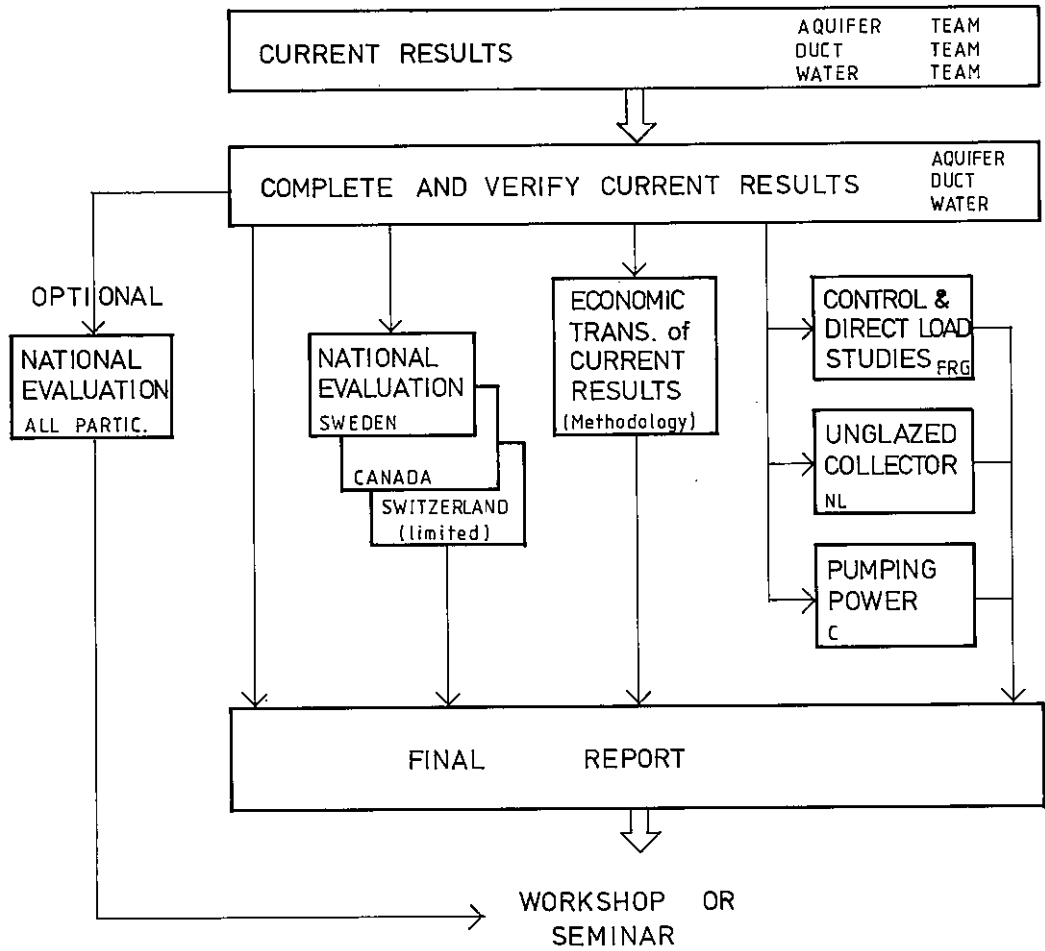

Fig. 4 General Workscheme for Subtask II (b).

5. DESIGN SUMMARIES

The design summaries that follow have been written as short introductions to national reports, which give the full information about each project. Some of these reports have been published and are available through ordinary means; the other have to be specially ordered. A complete list of the national reports and ordering instructions are given in Appendix 1.

The national reports - although not formally IEA reports - are written according to a format that was developed in Task I of the IEA Solar Cooling and Heating Programme, and adopted for the purposes of Task VII. The idea was to have a uniform method of presenting the information in order to be able to compare the designs. Each report would ideally have all information that was needed to judge the feasibility and to take a national decision whether to proceed with construction or not.

It was stated already in the introduction to this report that the designs primarily have been based on the technical know-how in each country at the time, and not on the combined knowledge and experience of the group. Even if the exchange of information in the group of experts certainly has contributed to some of the designs, it is not correct to see them as expressions of a common belief of most promising concepts. It is therefore doubtful if a comparison will indicate in what direction a further development should go.

This inhomogeneous background is confirmed by the following comparison, tables III and IV, offered by J-O Dalenbäck at the Chalmers University of Technology, Göteborg, Sweden. In this comparison three existing Swedish projects in operation are included, which are not presented in the overview in chapter 3.

In the overview table III data from chapter 3 are compared. It can be seen that projects in operation are small compared to most of the theoretical studies. They are all the first of it's kind in the different countries, and the size is probably only significant for the available funds for experimental R & D.

Table IV shows clearly the variety in concepts and solutions. Even projects with the same concept show very different designs, which cannot be justified by different climates. The comparison confirms the need for a more systematic parametric analysis, which also is underway in Phase II of Task VII.

TABLE III A. THEORETICAL IEA-STUDIES - DESIGN DATA

| | Heat storage (m3) | Solar collectors (m2) | Load (MWh /year) | Auxilliary/Load (%) |
|-----------|--------------------------------|-----------------------|------------------|--------------------------------|
| 1 Denmark | Pit 50.000 | Flat plate 6.600 | 2.600 | el energy to HP 21 |
| 2 CEC | Vert earth coil 90.000 | Flat plate 10.000 | 6.400 | el energy to HP 24 |
| 3 FRG | Steel tank 3.000 | Evac tube 800 | 500 | 23 |
| 4 Sweden | Steel tank 55.000 | Flat plate 13.000 | 3.700 | el energy to HP 20 |
| 5 U.K. | Steel tank 7.500 | Evac tube 3.600 | 900 | 16 |
| 6 U.S.A. | Underground conc tank 5.700 | Flat plate 2.300 | 2.200 | el energy to HP 15 + gas 37 |

TABLE III B. IEA-PROJECTS IN OPERATION - DESIGN DATA

| | | | | |
|-----------------|---------------------------|--------------------|-------|--------------------------------|
| 7 Austria | Hor earth coil 70.000 | Uncovered 400 | 1.200 | el energy to HP 32 + oil 2 |
| 8 Canada | Aquifers 800.000 | Evac tube 1.300 | 6.620 | el energy to HP |
| 9 Nether-lands | Vert earth coil 23.000 | Evac tube 2.400 | 1.200 | 34 |
| 10 Switzer-land | Hor earth coil 3.500 | Flat plate 500 | 900 | el energy to HP 19 + oil 35 |

TABLE III C. 3 SWEDISH PROJECTS IN OPERATION - MEASURED DATA

| | | | | |
|---------------|---------------------------|---------------------|-------|-------------------------|
| 11 Sunclay | Vert earth coil 87.000 | Uncovered 1.500 | 1.000 | oil to HP 60 |
| 12 Lambohov | Pit 10.000 | Flat plate 2.800 | 900 | el energy to HP 25 |
| 13 Ingel-stad | Conc tank 5.000 | Flat plate 1.400 | 900 | el energy 50 + oil 5 |

TABLE IV. DIFFERENT CONCEPTS

| | Solar collectors | t in storage (°C) | HP | Projects |
|------------------------------------|------------------|-------------------|-----|----------|
| <u>Duct storage</u> ¹⁾ | Uncovered | < 15 | Yes | 7, 10 |
| | Flat plate | > 50 | Yes | 2, 9 |
| | Evac tube | > 30 | No | 8 |
| <u>Water storage</u> ²⁾ | Flat plate | < 30 | Yes | 1 |
| | Flat plate | > 50 | No | 12 |
| | Flat plate | > 50 | Yes | 4, 6, 11 |
| | Evac tube | > 50 | No | 3, 5 |

1) Heat Capacity (J/m³ K) 2 - 3,6 x 10⁶

2) Heat Capacity (J/m³ K) 4,2 x 10⁶

Another comparison, table V, was offered by Aad Wijsman at TNO Netherlands. It can be argued, that the dimensionless characteristic number, which he suggests, should have a value of 3-5 in an optimal design. The great deviations he has found from this value indicate a mismatch between collectors and storage.

Is there a general line in the national designs? Table V compares the ratio F between total solar insolation and storage capacity.

$$F = \frac{\text{Total solar insolation}}{\text{Storage capacity}} = \frac{A_{\text{col}} \times G}{V_{\text{store}} \times \rho \times c_p \times \Delta T_{\text{store}} / 3.6 \cdot 10^6}$$

with

A_{col} = collector area, m^2

G = total annual insolation, kWh/m^2

V_{store} = volume of the store, m^3

ρ = density, kg/m^3

c_p = specific heat, J/kg

ΔT_{store} = annual temperature swing in the store, $^{\circ}\text{C}$

TABLE V. RATIO F BETWEEN TOTAL SOLAR INSOLATION AND STORAGE CAPACITY FOR DIFFERENT PROJECTS

| LAND | A_{col} m^2 | G kWh/m^2 | V_{store} m^3 | T_{store} $^{\circ}\text{C}$ | F |
|-------|----------------------------------|--------------------------------|------------------------------------|--|-----|
| D | 6.600 | 1.025 | 50.000 | 30 | 3,9 |
| CEC * | 7.000 | 1.225 | 60.000 | 52 | 3,6 |
| FRG | 800 | 975 | 3.000 | 60 | 3,7 |
| S | 13.000 | 1.050 | 55.000 | 55 | 3,9 |
| UK | 3.600 | 950 | 7.500 | 55 | 7,1 |
| USA | 2.300 | 1.250 | 5.700 | 55 | 7,9 |
| A * | 400 | 1.050 | 70.000 | 13 | 0,7 |
| NL * | 2.400 | 975 | 23.000 | 30 | 4,4 |
| CH * | 500 | 1.200 | 3.500 | 50 | 4,4 |

*) : Soil

AUSTRIA

ALTERNATIV-ENERGIE-ANLAGE INNSBRUCK-KRANEBITTEN

The erection of military barracks in Innsbruck-Kranebitten offered the opportunity to install a low-cost-seasonal-soil-storage beneath the drill-ground. The project is situated a few kilometers west of Innsbruck.

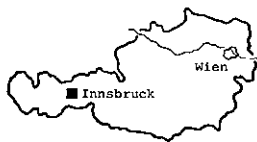

Latitude 47°16'
Longitude 11°21'
Altitude 627 m



Site Plan

CLIMATE

Mean annual global radiation sum on a horizontal surface 1112 kWh/m²
 January to March 178 kWh/m²
 April to June 417 kWh/m²
 July to September 388 kWh/m²
 October to December 129 kWh/m²
 Mean annual, ambient Air-Temperature, 8°C
 Heating degree-days (20°C/12°C) 3642
 Design temperature, heating -18°C

BUILDING AND LOAD DESCRIPTION

The barracks offer room for 800 soldiers; there are a supply-building, service- and sport-facilities. The seasonal-soil-storage, combined with a heat pump and the roof absorber on the supply building, is intended to cover the heat load of this building and the hot water requirement for all the buildings. The annual heat requirement is about 1370 MWh, of which about 55% are used for the hot water demand (40 m³ per day).

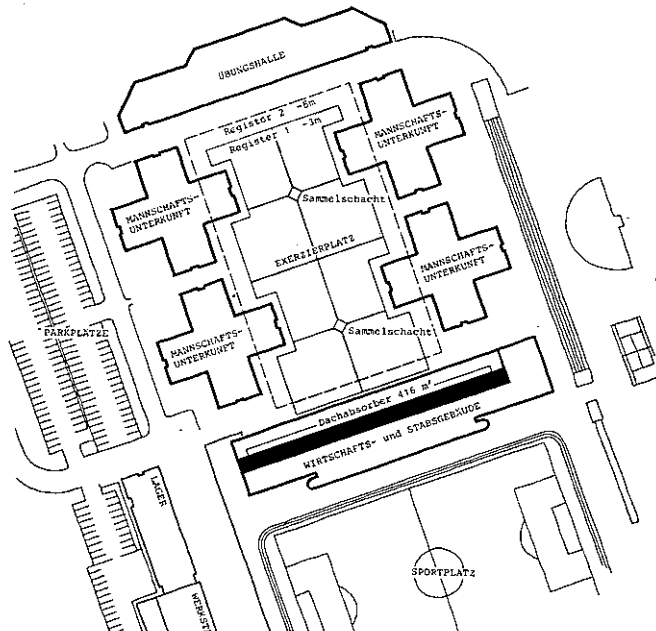

Building - general arrangement

SYSTEM DESIGN

The heat-pump is to meet the hot water demand with priority 1 and the heat demand for space heating with priority 2. Auxiliary heating is provided by an oil fired furnace.

Storage Subsystem

The seasonal-soil-storage is "open", there is no containment or insulation. The "effective storage depth" is about 12 m, the storage surface (exposed to air) is about 6000 m². The specific heat of the material is about 1.6 MJ/m³K. Loading and unloading of the soil-storage is effected by means of two horizontal pipe systems embedded in depth of 3 m (register 1) and 8 m (register 2) respectively. Each of this registers consists of about 120 polyethylene-pipes (20/2 mm) loops of 100 m length in parallel circuits.

Solar Collector Subsystem

The roof absorber consists of 416 m² plastic mats with an optical efficiency of 0.65 and a collector-heat-loss-coefficient of 21 W/m²K. The absorber mats are mounted directly on the 2° tilted south facing roof. Their water/glycol content is about 1.3 l/m².

Buffer Storage

The hot water for domestic use is stored in a 40 m³ short term storage which will be loaded during the night via heat-exchanger. The space heating works via a buffer-storage of 10 m³.

| | HEAT CAPACITY (MJ/m ³ K) | THERMAL CONDUCTIVITY (W/mK) |
|--------|-------------------------------------|-----------------------------|
| SAND | 1.76 | 1.51 |
| SAND | 1.38 | 0.6 |
| GRAVEL | 1.5 | 1.5 |
| SAND | Register 1 -3m | 1.7 |
| GRAVEL | 1.5 | 1.5 |
| SAND | Register 2 -8m | 1.7 |
| GRAVEL | 1.5 | 1.5 |

Storage Schematic

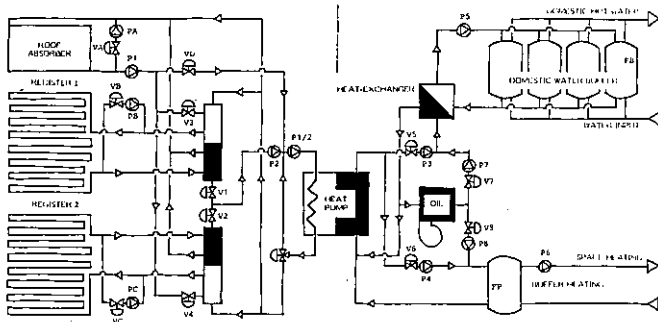

System Schematic

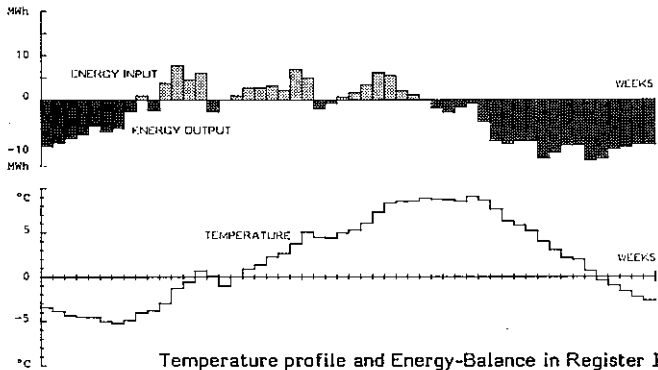

Temperature profile and Energy-Balance in Register 1

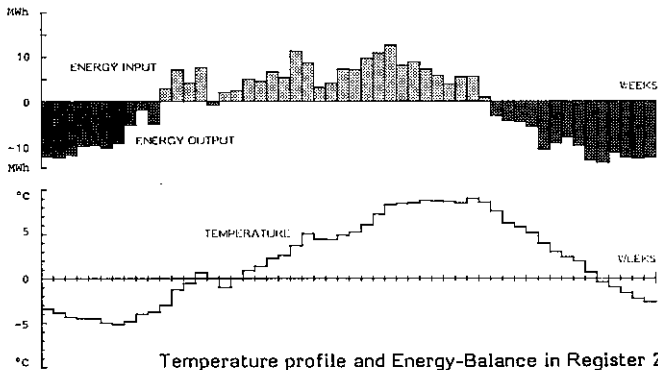

Temperature profile and Energy-Balance in Register 2

PERFORMANCE DATA

| Energy flows | MWh/year | % of tot.energy |
|-------------------------------|----------|-----------------|
| Total energy demand | 1367 | 100 |
| Auxiliary energy (oil) | 29 | 2 |
| Heat-pump output | 1338 | 98 |
| Heat-pump electr. input | 438 | 32 |
| Absorber to heat-pump | 100 | 7,5 |
| Register 1 to heat-pump | 429 | 31,5 |
| Register 2 to heat-pump | 371 | 27 |
| Absorber to register 1 | 265 | 19 |
| Absorber to register 2 | 315 | 23 |
| Register 1 (collector effect) | 164 | 12 |
| Register 2 (collector effect) | 56 | 4 |

Temperature swing of the soil near registers: -5°C to +9°C

Distribution Subsystem

The roof absorber serves foremost to load the soil storage. A direct supply to the heat-pump is also possible. The primary circuits of the heat-pump consist of the two register-circuits and the absorber-circuit. Heat is directed via heat exchanger to the daily hot water storage or to the space heating buffer.

Heat Pump

For technical reasons the connected load of the heat-pump had to be limited to 102 kW. The maximum heat output of the water/glycol-water heat-pump is about 350 kW (Evap. 5°C, Cond 50°C).

Control System

A free programable computer system is used as central control unit. The well defined aim of the control strategy to be adopted is to minimize the operating and maintenance costs of the entire system.

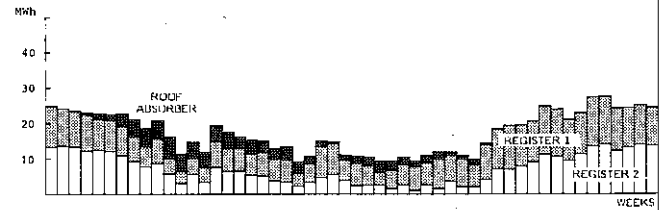

Weekly gains of "ambient" energy, low temperature heat from Absorber, Register 1 and Register 2

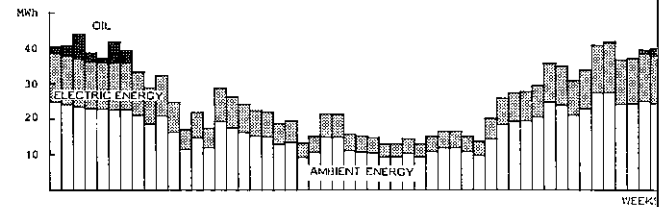

Weekly energy distribution oil, electric energy and low temperature heat

CONCLUSIONS

About 66% of the total energy requirement is covered by ambient energy. About 50% of the low temperature heat supplied to the heat-pump are delivered directly or by means of the seasonal-soil storage by the low temperature collector system, whereas about 16% come from the natural sources of energy of the ground. The investment costs of such projects are determined most of all by the expenses for the erection of the soil storage. In this special case the starting conditions have been very favourable because an already existing gravel pit could be used. The investment costs for the solar part of the entire heating system are about 5.9 million Austrian Shillings (AS). The annual energy costs are assumed to be about AS 463,000.00, the maintenance costs for the solar part to be about AS 99,000.00. For a conventional oil fired system the annual energy costs amount to about AS 1.172,000.00. The comparison of the cost increment of the solar system (AS 5,900,000.00) and of the reduction of annual operating costs (AS 610,000.00) results in a pay-back-period of 8 to 10 years.

CANADA

PROJECT DESCRIPTION

This study was undertaken to examine the feasibility of meeting the space heating requirements of the newly designed Scarborough Government of Canada Building (GOCB) using an aquifer in combination with solar, heat recovery and heat pump systems. Three basic alternative designs were analyzed:

- solar produced 70°C heat, aquifer storage and no heat pump,
- solar produced 50°C heat, aquifer storage and a heat pump as required,
- waste heat recovery at 33°C, aquifer storage and heat pump upgrade to delivery temperature (41°C).

CLIMATE

Scarborough, Ontario, Canada is close to the city of Toronto and Lake Ontario, at 44° North latitude and 79° West longitude.

| Insolation on a horizontal surface: | | |
|-------------------------------------|-------------------|--------------------|
| | MJ/m ² | kWh/m ² |
| Annual average | 5019 | 1394 |
| Daily average, December | 4.1 | 1.1 |
| Daily average, June | 23.2 | 6.4 |

Mean ambient temperature

| | |
|---------|--------|
| January | -6.3°C |
| July | 20.8°C |

Heating degree-days (below 18°C)

| | |
|--------|------|
| Annual | 3939 |
|--------|------|

BUILDING AND LOAD DESCRIPTION

The Scarborough GOCB has 29,000 m² of usable floor area over 14 floors for offices and services.

The building is characterized by a large cooling load for most of the year (a balance temperature of -20°C when occupied) and with a simultaneous internal heating (at perimeter) and cooling (in building core) requirement.

Conventional design includes: heat pumps for internal energy redistribution, electrical resistance auxiliary heating, short-term water storage tanks, and a cooling tower/chiller. Special design features include solar collectors for domestic water heating (DHW) and space heating, and two aquifers. Current design includes using only one aquifer (the lower aquifer) primarily for seasonal cooling purposes. This feasibility study examines the suitability of using the second (upper) aquifer for thermal storage for space heating. The space heating requirement assumed to be met by the solar and (upper) aquifer system is 1000 GJ (278 MWh) over the period December to February only.

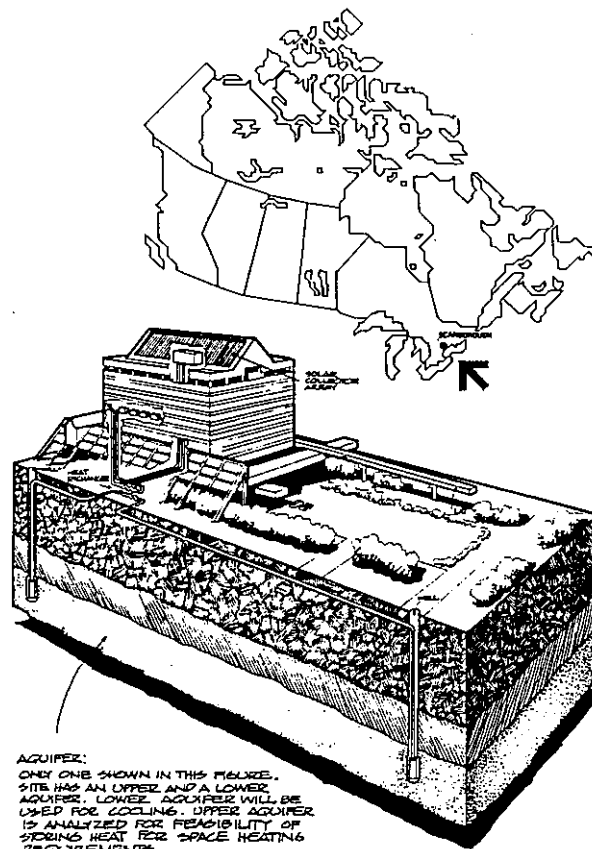

AQUIFER:
ONLY ONE SHOWN IN THIS FIGURE.
SITE HAS AN UPPER AND A LOWER
AQUIFER. LOWER AQUIFER WILL BE
USED FOR COOLING. UPPER AQUIFER
IS ANALYZED FOR FEASIBILITY OF
STORING HEAT FOR SPACE HEATING
REQUIREMENTS.

SUMMER OPERATION

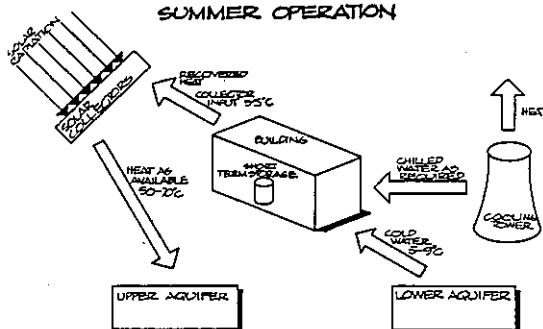

WINTER OPERATION

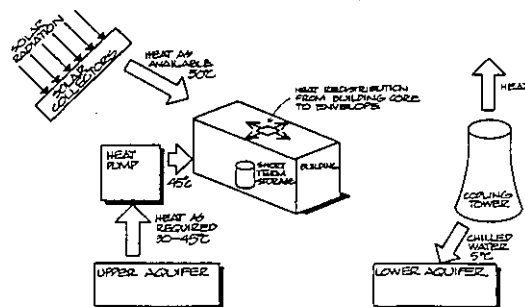

SYSTEM DESIGN

High Temperature Alternative

- collector sub-system provides heat at minimum 70°C for storage in aquifer,
- collector sub-system provides additional heat during December - February as available,
- no heat pump is used--storage temperature is always greater than load temperature required (41°C).

Medium Temperature Alternative

- collector sub-system (smaller than case above) provides heat at minimum 50°C for storage in aquifer,
- collector sub-system provides additional heat during December - February as available,
- a heat pump upgrades storage temperature as required for load.

Low Temperature Alternative

- collector sub-system is not used for space heating requirements at all (collector sub-system used as in current design which is for year-round DHW purposes only),
- heat recovered from building during May - September (inclusive) at 35°C is stored in aquifer,
- a heat pump upgrades storage temperature as required for load.

SYSTEM PERFORMANCE

| | High Temp. | Medium Temp. | Low Temp. |
|----------------------------------|------------|--------------|-----------|
| Collector area (m ²) | 1300 | 1050 | - |
| Energy to storage (% of load) | 152 | 123 | 155 |
| Net storage loss (% of load) | 81 | 42 | 76 |
| Storage to load (% of load) | 65 | 67 | 79 |
| Collector to load (% of load) | 35 | 28 | - |
| Heat pump electric (% of load) | - | 5 | 21 |
| Total load (% of load) | 100 | 100 | 100 |
| Heat pump COP | - | 6.75 | 4.72 |

OBSERVATIONS

The Low Temperature Alternative is between one fourth and one fifth the cost of the higher temperature alternatives which include solar collection. This low cost is attributable to:

- taking advantage of design opportunities for a new building such that some system requirements can be made available at minimal additional cost;
- waste heat recovery is available on-site at essentially zero cost;
- the aquifer cost is very low - in the range of one to two dollars per m³.

SUMMER JUNE, JULY, AUGUST

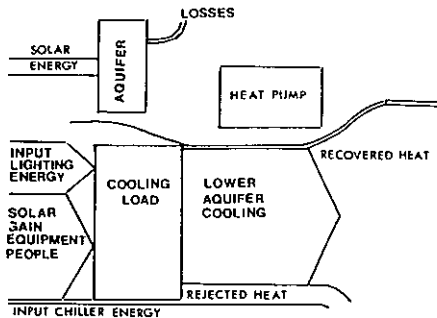

WINTER DEC, JAN, FEB

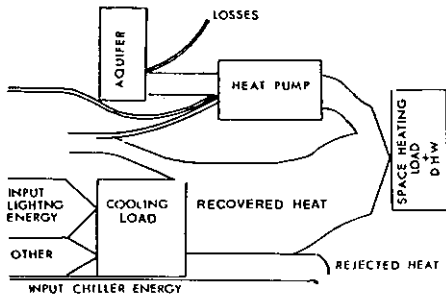

SCHEMATIC OF SPACE HEATING SYSTEM
SUMMER OPERATION (CHARGING AQUIFER)

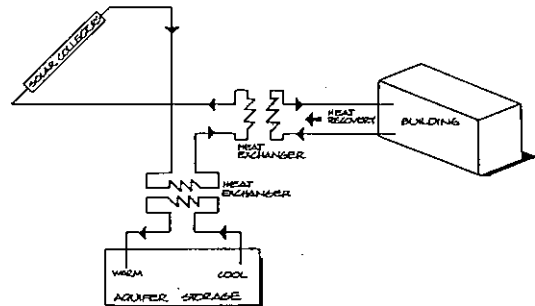

WINTER OPERATION (SPACE HEATING)

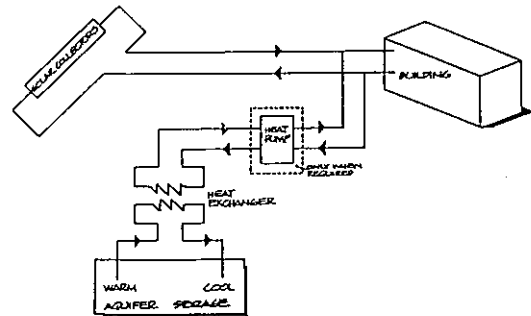

CEC

PROJECT DESCRIPTION

This project is a preliminary design for a solar heated high school center located in Ispra (Northern Italy).

The actual realization of the project is not foreseen.



CLIMATE

Ispra is located about 60 km NW from Milan (45° 48' N, 8° 37' E, 220 m above sea level).

| | | |
|---|------|-------------------|
| Annual horizontal irradiation..... | 4200 | MJ/m ² |
| Number of the degree days (base 18.3 C)..... | 2450 | |
| Precipitation..... | 1600 | mm |
| Average ambient temperature..... | 11.4 | °C |
| Average humidity..... | 75 | % |
| Average wind speed..... | 1.4 | m/s |
| Average temperature in January..... | 2.0 | °C |
| Horizontal global irradiation in January..... | 187 | MJ/m ² |
| Minimum design temperature..... | -5 | °C |

BUILDING AND LOAD

The load consists of a large multipurpose community building, located in the outskirts of a small town.

The building can be divided in five different areas:

- schools
- cultural and recreation (theatre, library etc.)
- sports
- dormitories
- administration and services

The building is made in the form of a triangle and the attempt was made to find a compact form which allows the installation of a large collector array on the roof. The walls facing South-east have a passive solar heating system.

The principle data of the building are:

| | | |
|---------------------------------|---------|----------------|
| Volume..... | 180,000 | m ³ |
| Floor area..... | 42,000 | m ² |
| Yearly heating load..... | 6,444 | MWh |
| Passive solar contribution..... | 14 | % |

In this preliminary phase, only the space heating load is considered.

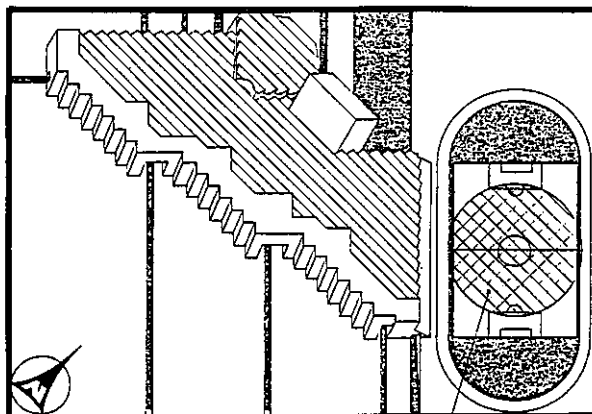

AXONOMETRIC VIEW

Storage

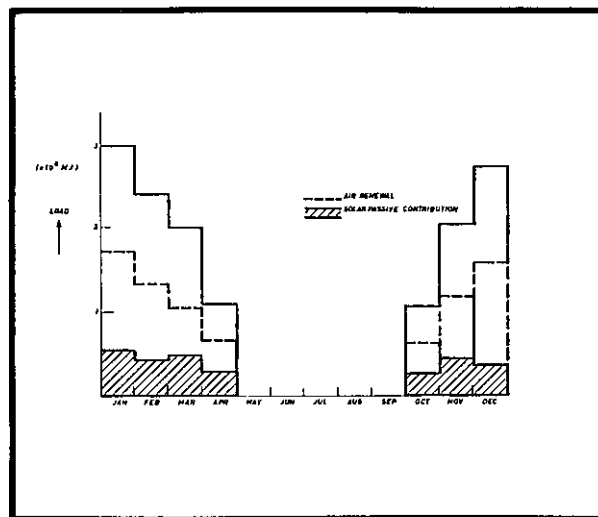

HEATING LOAD

SOLAR HEATING SYSTEM

The solar heating system consists of flatplate collectors intergrated in the roof, two small buffer storages (150 and 50 m³), a seasonal heat storage using vertical tubes in the ground and a heatpump.

The ground used for this storage is a mixture of sand, clay and gravel.

The system must supply about 5000 MWh per year to the load with a peak demand of 2.2 MW. No auxiliary heater is foreseen.

The principle data are:

| | | |
|-------------------------------------|--------|----------------------|
| Collector surface..... | 10,000 | m ² |
| Volume seasonal storage..... | 90,000 | m ³ |
| Duct density..... | 0.25 | ducts/m ² |
| Duct diameter..... | 0.5 | m |
| Insulation on top of the store..... | 0.1 | m |
| Depth of the storage..... | 37 | m |
| Number of ducts..... | 643 | |
| Length of the ducts..... | 35 | m |

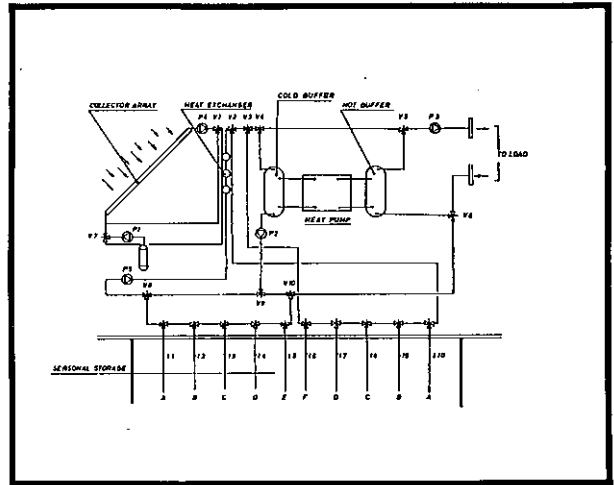

SYSTEM DIAGRAM

SYSTEM PERFORMANCE

The system performance is simulated with the MINSUN program, version III.

The system optimization is not yet fully carries out. Therefore the results should be considered preliminary.

Some results are:

| | | |
|------------------------------------|------|-----|
| Building load..... | 6444 | MWh |
| Passive solar energy..... | 902 | MWh |
| Lights & people..... | 599 | MWh |
| Electricity for heatpump..... | 1176 | MWh |
| Active solar energy..... | 509 | MWh |
| Solar energy through heatpump..... | 3260 | MWh |
| C.O.P. heatpump..... | 3.8 | |
| Solar fraction..... | 76 | % |
| Auxiliary energy..... | 0 | MWh |

The are enrgy flows are shown in the energy flow diagram.

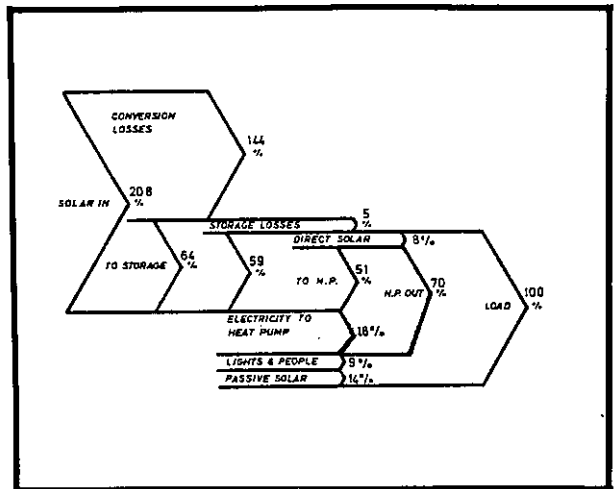

ENERGY FLOW

ECONOMICS

An economic analysis has been carried out. The Italian price level of the first quarter of 1983 was used.

The "simple pay back time" is about 16 years. A life-cycle cost analysis shows that with a real fuel inflation rate of 3 % and a real discount rate of 3 %, the present worth of all the costs of the solar system calculated over a period of 20 years are equal to the costs of a conventional system.

DENMARK

HJORTEKAER

CLIMATE

55°N 45', 12°E 30', 40 m
 Global rad. 1190 kWh/m²
 Mean amb. temp. 8°C
 Degree-days (-12/17) 2850

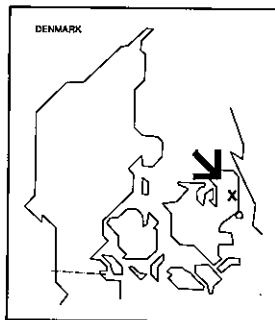

BUILDING AND LOAD DESCRIPTION

200 single-family houses with a total floor area of 30,000 m². Each house uses 10,000 kWh/yr for space heating and 3,500 kWh/yr for domestic hot water.

SYSTEM DESIGN

The system consists of solar collectors, storage and a heat pump. The reserve heat facility is an oil fired hot water boiler.

STORAGE SUBSYSTEM

A water pit storage which is uninsulated at the store/soil interface. The top has 0.5 m of insulation.

| | |
|-----------------------------------|-----------------------|
| Size of storage | 49,400 m ³ |
| Temperature when fully charged | 40°C |
| Temperature when fully discharged | 10°C |

SOLAR COLLECTOR SUBSYSTEM

The collectors are flat-plate and selective with one glass cover. They are mounted on the roofs of the houses, slope 45°. The total area is 6,600 m² and the operating temperatures are 30 - 55°C. The collectors are working only for half a year.

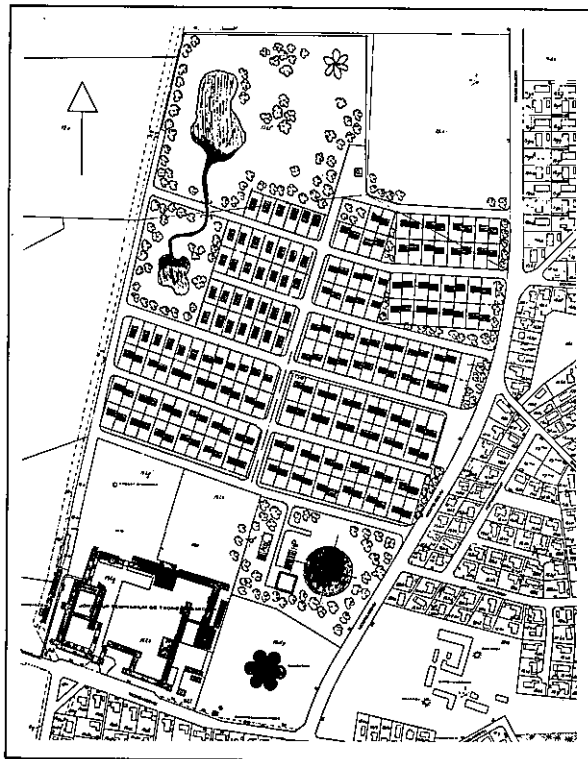

Site Plan

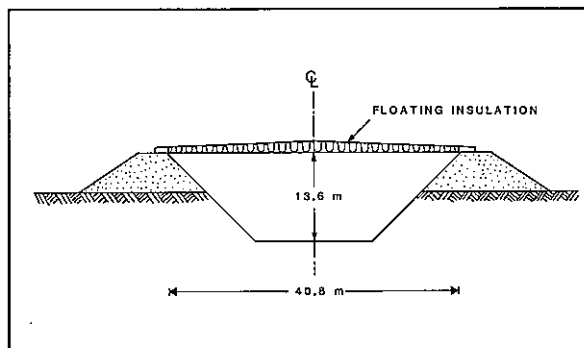

Storage Design

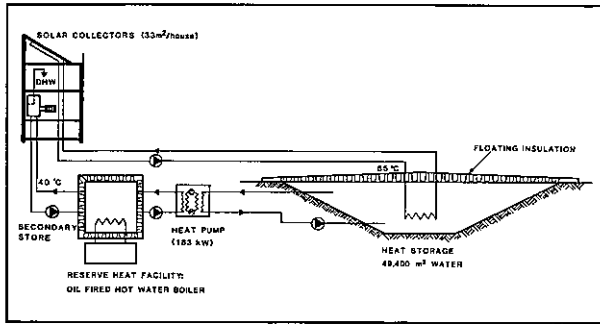

System Diagram

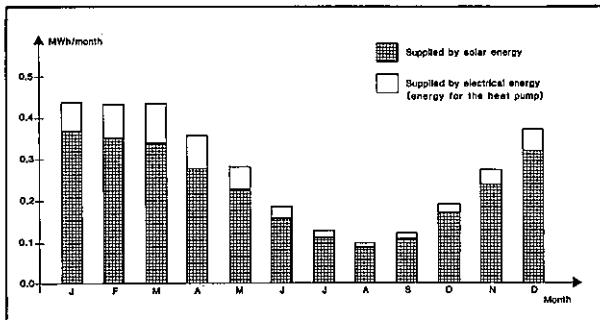

Energy Performance

PERFORMANCE DATA

| | |
|-------------------------------------|------------------|
| Total solar radiation on collectors | 7,920,000 kWh/yr |
| Solar energy utilized | 3,183,000 kWh/yr |
| Electricity for heat pump | 593,000 kWh/yr |
| Auxiliary energy | 0 kWh/yr |
| Solar cover fraction | 0.83 |

HEAT PUMP

The heat pump is working the whole year with an average COP = 6.7. The installed power is 183 kW.

DISTRIBUTION SUBSYSTEM

The heat pump supplies the building via a secondary storage and a district heating system where the operating temperatures are $40/(25 - 36)^\circ\text{C}$. The mass flow rates are constant.

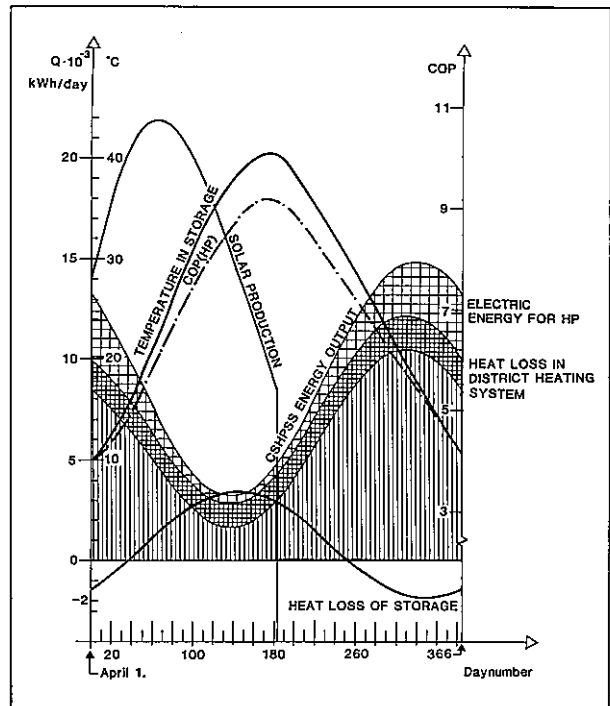

Energy Performance

CONCLUSIONS

The cost effectiveness of the energy produced in this CSHPSS with heat pump has been estimated to be about 0.11 US\$/kWh (30 years of operation, 8% interest rate, 2% fuel escalation). This price is almost identical with the price of electricity in Denmark and shows that the CSHPSS seems to be economically attractive.

FEDERAL REPUBLIC OF GERMANY

Wolfsburg-Glockenberg is located to the east of Hannover at latitude 52°26'N and longitude 10°47'E. The project is to supply heat to a number of housing units in a new residential area

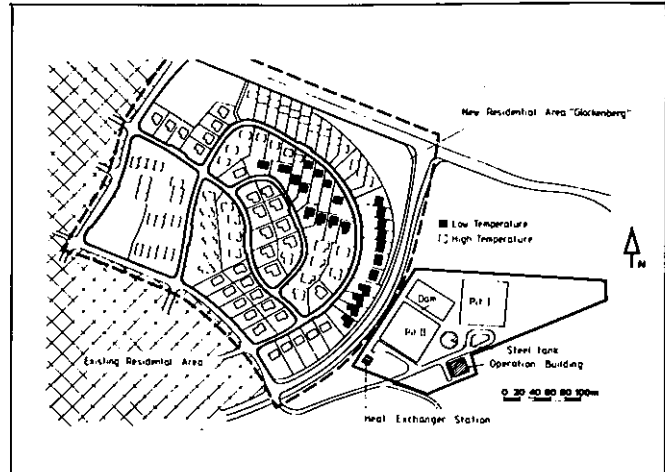
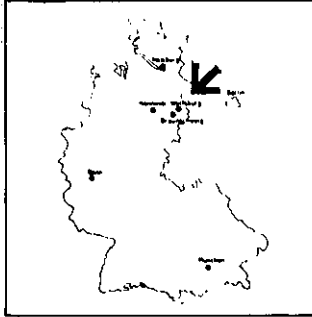

SITE PLAN

CLIMATE

| | |
|--------------------------|------------------------|
| Global Radiation..... | 990 kWh/m ² |
| Diffuse portion..... | 58% |
| Degree-Days (19/15)..... | 3700 DD |
| Sunshine Hours..... | 1550 Hrs |
| Average Temperature..... | 8.6 °C |
| Relative Humidity..... | 80% |

BUILDING AND LOAD DESCRIPTION

A new housing estate with 23 houses which are connected to a low temperature district heating network is involved. The houses are to be supplied with heat for space heating and for 75% of the hot water production.

| | |
|---------------------------------------|---------------|
| Space Heat Requirement per house..... | 17,000 kWh/yr |
| Domestic Hot Water per house..... | 3000 kWh/yr |
| Total demand in the network..... | 436 MWh/yr |

SYSTEM DESIGN

The system consists of a collector array with heat-pipe collectors, a steel tank acting as a seasonal store, and a heat exchanger.

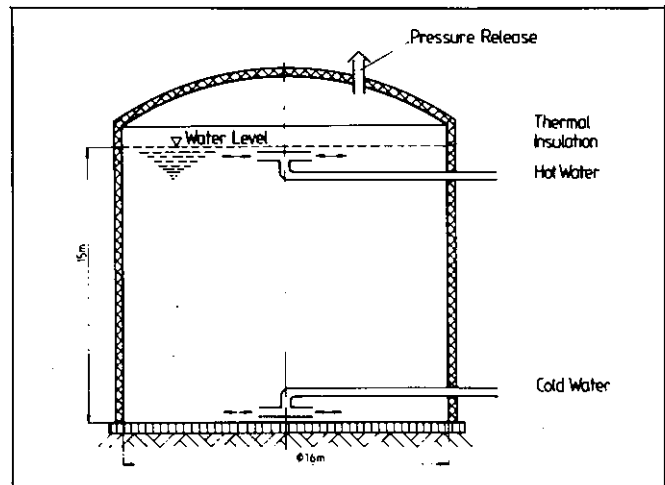

STORAGE DESIGN

Storage Subsystem

As there are only 23 houses to be supplied, the earth pit store, for which extensive design work has already been done in a concurrent project, cannot be installed for economic reasons. Instead a pressureless steel tank having a capacity of 3000 m³ with a diameter (=height) of 16 m, has been taken for calculating the system. The maximum temperature is fixed at 95°C. The minimum temperature is the return temperature of the network.

Solar Collector Subsystem

The collector area is 800 m². Heat pipe collectors, tilted at 30° and directed to the south, were used for the calculations. For an average temperature of 50°C the energy output of this collector is about 600 kWh/m². Thus a system of 800 m² produces a total of 480 MWh/yr.

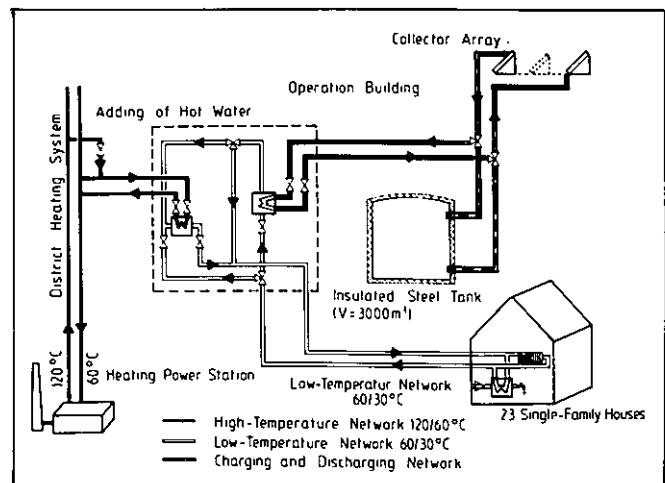

SYSTEM DESIGN

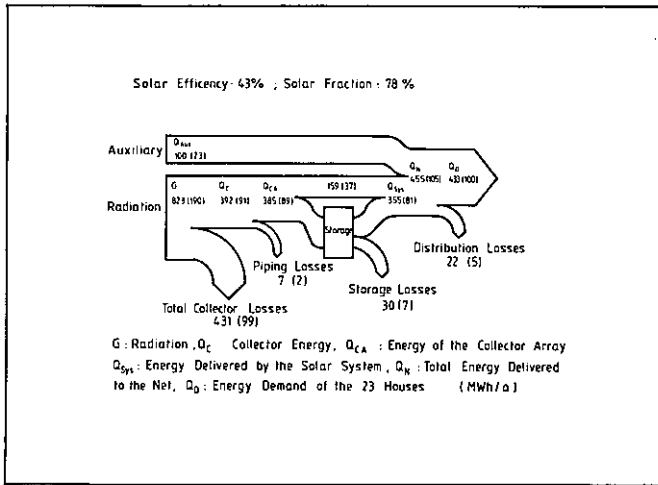

ENERGY FLOW

Distribution Subsystem

The collector and storage circuits are connected together directly. This is possible when using heat-pipe collectors. Because of the difference in the quality of the water, a heat exchanger is required between the storage circuit and the low-temperature district heating network. For the same reason a heat exchanger is also necessary between the high-temperature (back-up system) and the low-temperature network.

Control System

An attempt is being made to achieve a maximum useful temperature in the collector circuit by variable mass flow. The direct supply to the customer has precedence over charging of the store.

PERFORMANCE

| | |
|-------------------------------------|------------|
| Global solar radiation..... | MWh/yr 823 |
| Solar energy converted..... | 385 |
| Solar energy provided directly..... | 159 |
| Stored energy..... | 226 |
| Solar energy provided (total)..... | 355 |
| Auxiliary..... | 100 |
| Distribution losses..... | 22 |
| Total consumption..... | 433 |

CONCLUSIONS

Favorable conditions exist in Wolfsburg for a later realization of a low-temperature district heating network with sufficient area available for the collector array and storage. For a solar efficiency of more than 40% the system has a solar coverage of 78% for this system design. In spite of good technical results, an economic analysis has shown that the central solar heating plant with seasonal storage (CSHPSS) is too expensive by a factor of 2, under present conditions.

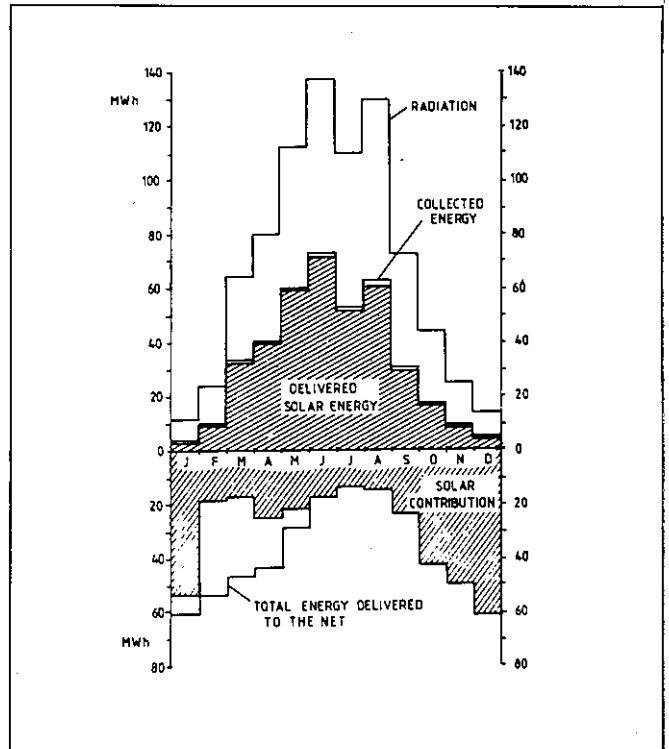
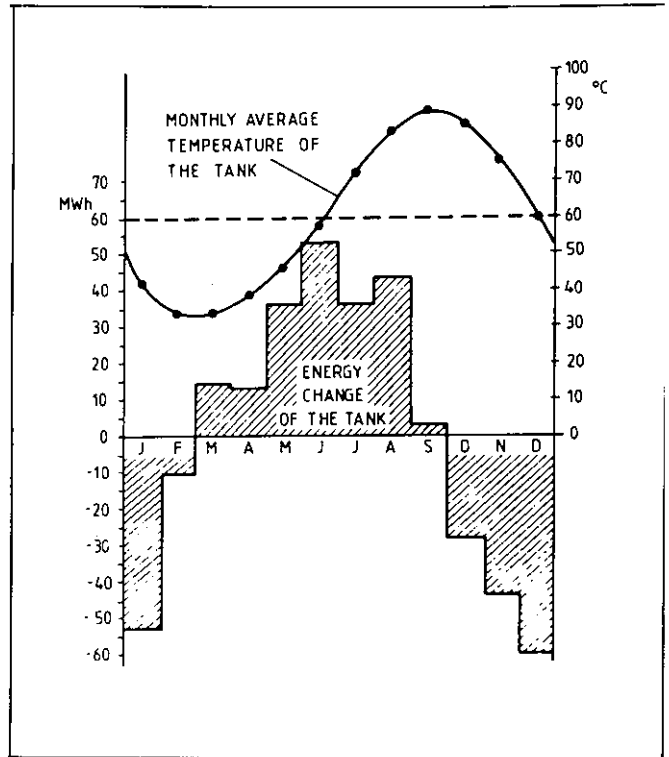

RESULTS

THE NETHERLANDS

Project Description

The Groningen Project consists of a group of 96 solar houses with seasonal heat storage in the subsoil. This solar system delivers a substantial amount of the heat demand for space heating and for domestic hot water heating.



The objective of this study is to gather practical experience with the design, construction and operation of a large scale seasonal heat storage system.

Location and site

Groningen is a town in the northern part of the Netherlands: latitude $53^{\circ}15'$, longitude $6^{\circ}15'$.

The soil can roughly be described as water saturated sand with thick layers of clay and some thin layers of peat.

Climate

The climate has a strong maritime tendency with a moderate character (rather low temperatures in summer and relatively high temperatures in winter).

Annual solar radiation.: 3510 MJ/m^2
(975 kWh/m^2)

Mean annual ambient temperature: 8.4°C

Average annual wind speed : 3.3 m/s

Number of degree days 18°C : 3600

Building and load description

The solar houses are built in rows, which are east-west oriented. The houses have a living floor and a sleeping floor, each of about 50 m^2 .

The houses are built better than required according to the 1981 building codes in the Netherlands: heat demand at design conditions is 6.3 kW .

In the houses the heat for space heating is delivered by a low temperature heating system (42.5°C at design conditions).

The projected annual heat demand for space heating is $10,000 \text{ kWh}$ and for domestic hot water $2,000 \text{ kWh}$. Both values per house. So the total annual system load is 1160 MWh .

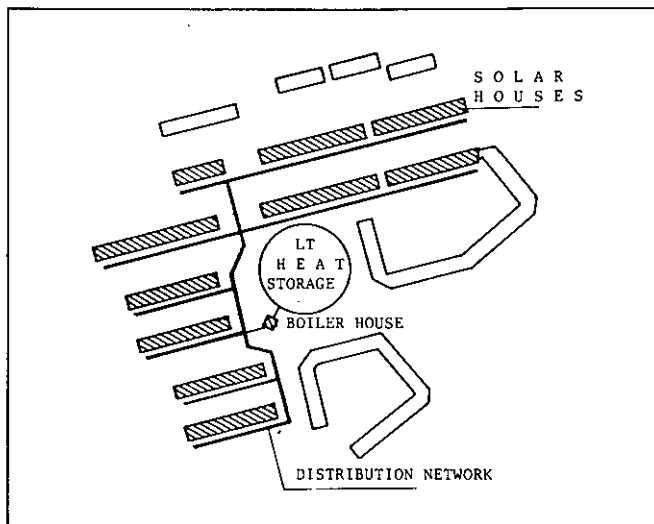

SITE PLAN

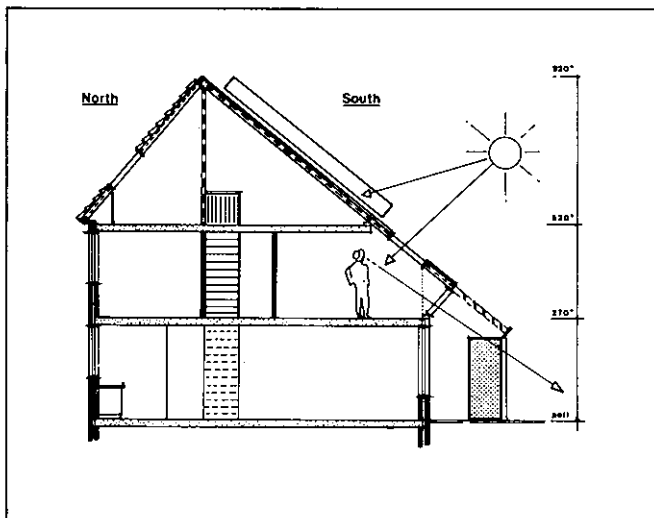

BUILDING CONSTRUCTION

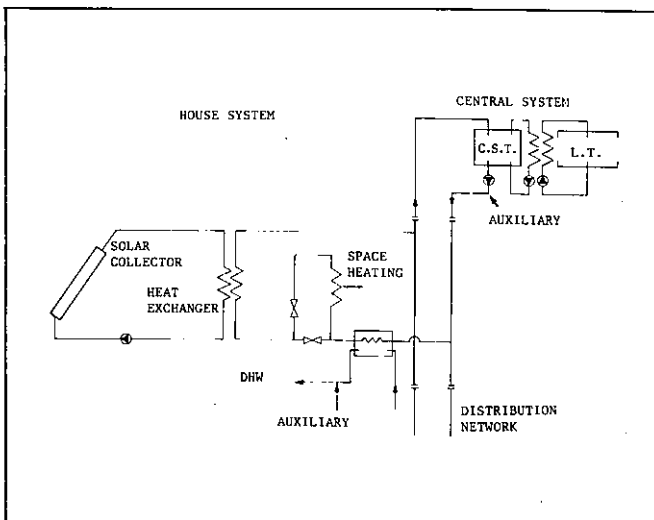

SYSTEM DESIGN

System design

The 96 solar houses are connected to the central heat storage system in the soil by a distribution network. For space heating there is a central auxiliary, for domestic hot water each house has its own back-up system.

- Storage system

The seasonal storage reservoir consists of a layer of soil with a heat exchanger. The reservoir is not bounded by walls. Only at the top the reservoir is furnished by an insulation foam layer. The heat exchanger consists of vertical tubes. In the centre of the soil reservoir a water tank is buried, acting as short term (daily) storage.

The volume of the seasonal heat store is 23,000 m³ (diameter 38 m, depth 20 m), the volume of the water tank is 100 m³.

- Solar collector system

Each house has 25 m² of evacuated tubular solar collectors on the roof. Total collector area: 2,400 m².

- Distribution network

The distribution network between the solar houses and the heat storage system has a total length of about 1900 m.

System performance

Calculations with a TPD simulation model of the Groningen system, show that after 3 years of operation the system delivers 65% of the total heat load. This means a net solar contribution of 320 kWh per m² of solar collector. The seasonal heat store operates between 28 and 60 °C. Its performance is about 70%.

Current situation Groningen project

The seasonal heat store was built in the second half of 1982. Experiments started in February 1983. The solar houses will be connected to the store in the summer of 1984. The system will be in full operation by the end of 1984 and will be monitored for 2-3 years.

Résumé

In the Groningen system, consisting of 96 solar houses with seasonal heat storage in the soil, the sun will deliver about 65% of the total load for heating and domestic hot water.

The total system will be in full operation by the end of 1984.

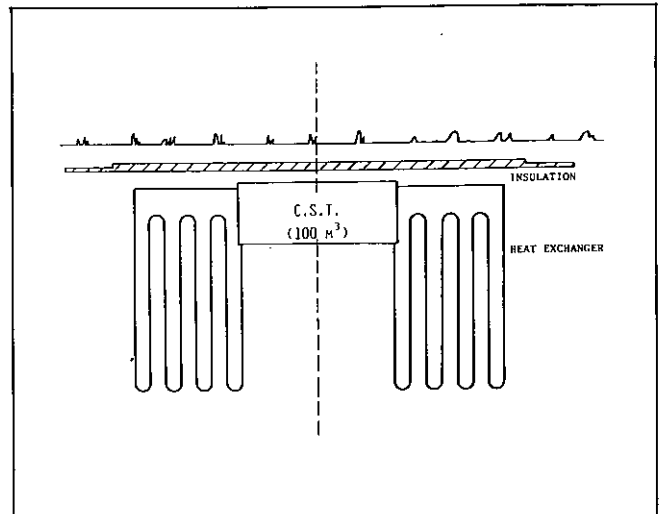

STORAGE DESIGN

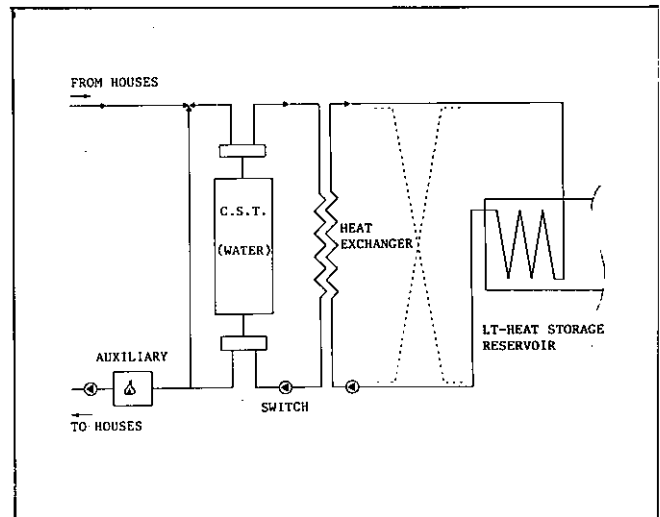

STORAGE SYSTEM CONTROL

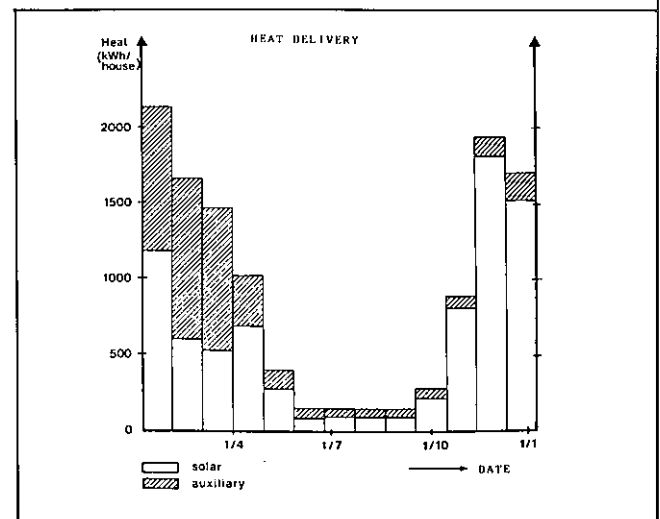

SYSTEM PERFORMANCE

SWEDEN

THE SÖDERTUNA PROJECT

The community of Södertuna is situated about 15 km south of Södertälje, 50 km from Stockholm. The latitude is 59°5'N and the longitude is 17°36'E.

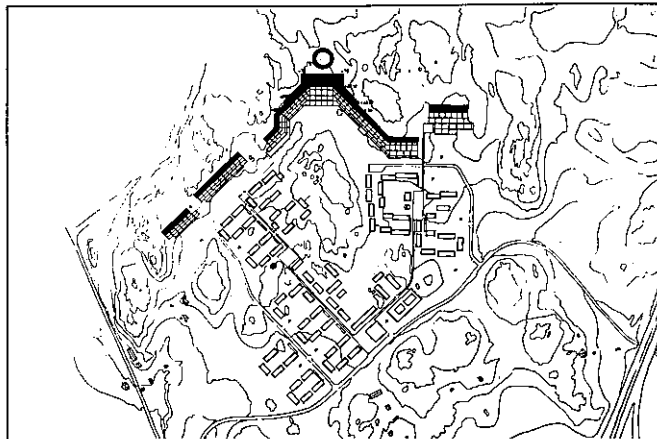
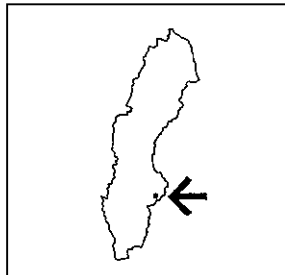

Site Plan

CLIMATE

| | | |
|---|------------------------|------|
| Total sunshine on horizontal surface..... | kWh/m ² -yr | 1064 |
| Total sunshine on vertical surface..... | | 757 |
| Total sunshine on horizontal surface, Dec..... | | 7 |
| Total sunshine on horizontal surface, July..... | | 179 |
| Mean annual temperature..... | +6°C | |
| Design ambient temperature..... | -18°C | |
| Degree-Days (base +17°C)..... | | 3850 |

BUILDING AND LOAD DESCRIPTION

The residential district will comprise 525 apartments (appr. 47,000 m²) and communal facilities of about 3500 m², for a total of about 50,000 m². The Södertuna energy project is a "hybrid" active/passive system in which the energy requirement of the residential portion was reduced 40% below the existing Swedish energy standards for housing.

The solar collectors of the active system, which supplies 80% of this reduced load, have been concentrated on the terrace houses as the outer surface of the roofs.

| | |
|---|------------|
| Space Heating Requirement..... | 3.2 GWh/yr |
| Peak Power Demand (at -18°C ambient)..... | 1.8 MW |
| Domestic Hot Water Requirement..... | 2.5 GWh/yr |
| Peak Power Demand for DHW..... | 1.9 MW |

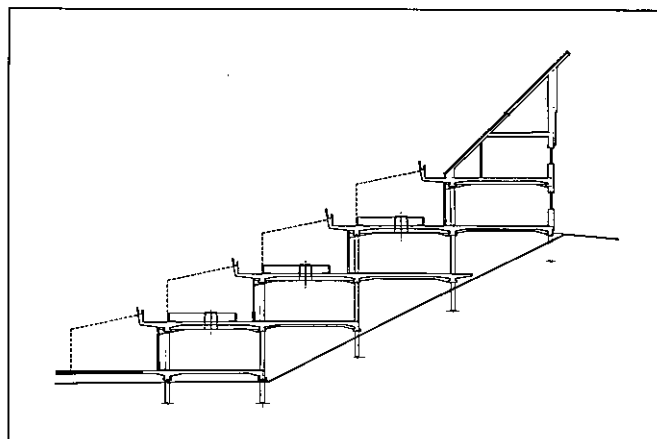

Building Section

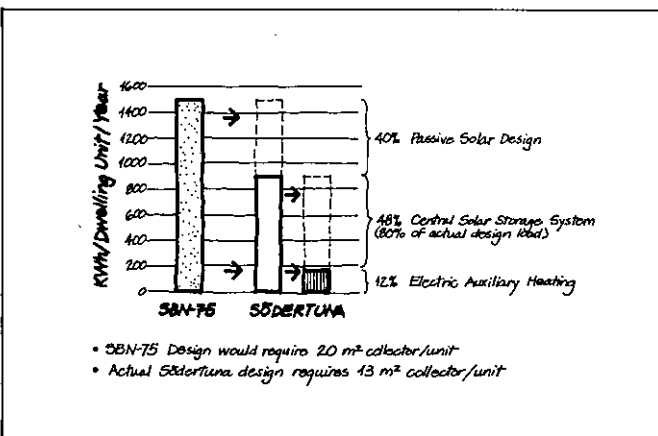

System Size Reduction by Passive Design

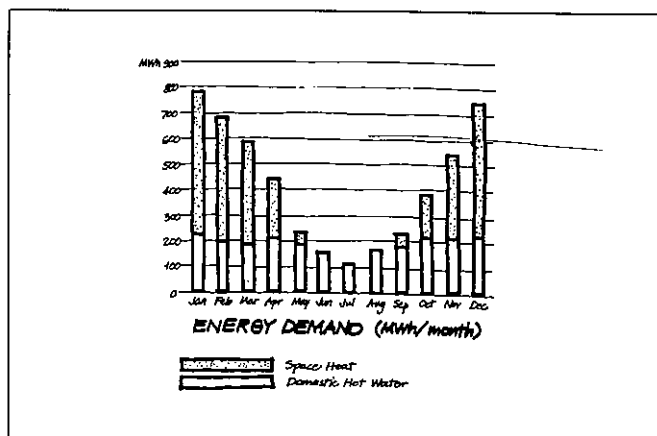

Final Design Load Profile

SYSTEM DESIGN

The system is a hybrid of a solar energy system with seasonal storage and two electrically-driven heat pumps.

Storage Subsystem

Three alternative heat storage facilities have been considered, each of which is feasible for the area in question.

| | |
|----------------------|-----------------------------|
| Steel tank | 55,000 m ² water |
| Rock chamber | 70,000 m ² water |
| Multiple well system | 145,000 m ² rock |

Calculations of heat losses, temperature stratification, design and costs were carried out for the steel tank, which comprises the primary proposal.

Solar collector, Sub-system

The solar collectors consist of a trapezoidal corrugated roofing sheet, insulated below, plus Sunstrips and a plastic cover. The energy produced by the solar collectors at an average collector temperature of 40°C is about 370 kWh/m² per year, i.e. approx. 4.3 GWh/year.

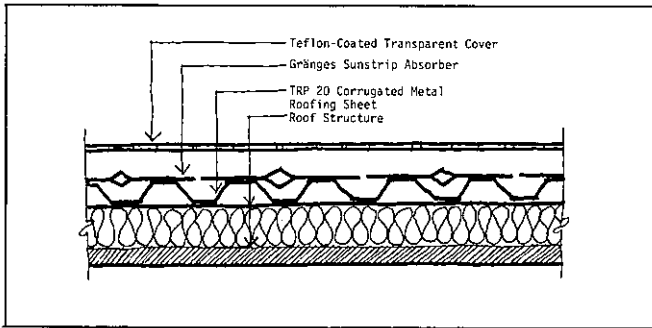

Solar Collector Design

Heat Pumps

Both heat pumps work internally with the thermal storage. The temperature of the upper portion of the tank is raised to 60°C - 70°C at the same time when the temperature near the bottom is lowered to 15°C. The low-temperature water is used to cool the collectors and increase their efficiency. The high-temperature water created by the heat pumps permits a reduced volume of the storage.

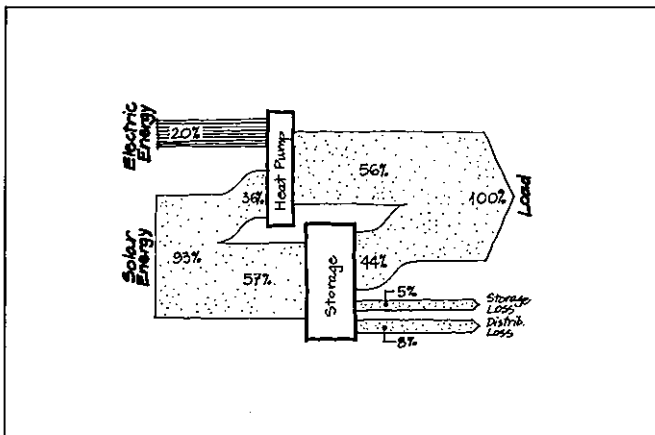

Energy Flow Diagram

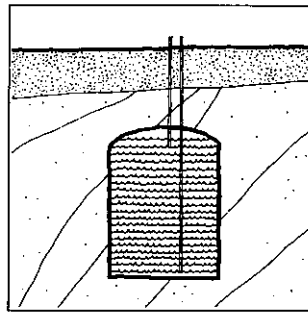

Rock Cavern

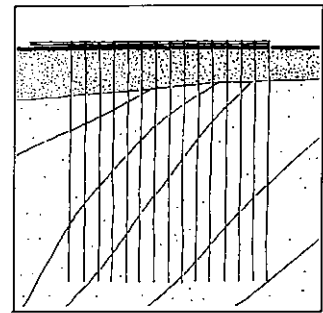

Multiple Well System

**Alternatives:
Storage System
Design**

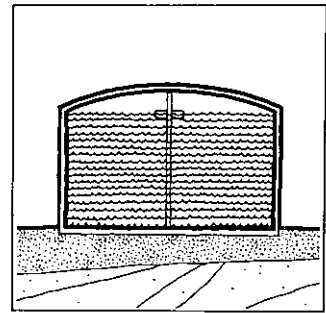

Steel Tank

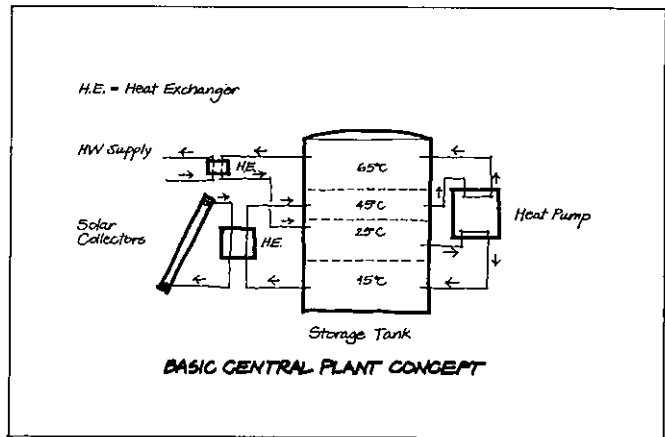

Storage System Design

ECONOMICS

In estimating the cost of the project the solar heating system (CSHPSS) was compared with a conventional heating method. The latter was defined to consist of a centralized heat supply system using a common electric central heating boiler. These calculations show that the CSHPSS system is cost effective for several realistic economic scenarios.

SWITZERLAND

THE VAULRUZ PROJECT

The Vaulruz Project consists of some solar-heated garages and an administration building. Vaulruz is located near Berne, at latitude $+6^{\circ}38'$, longitude $6^{\circ}58'E$ and at an altitude of 847 meters.

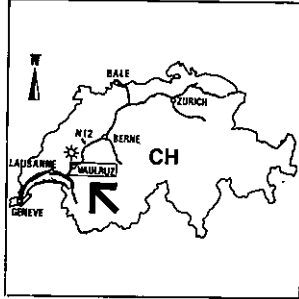

CLIMATE

| | |
|--------------------------|-----------------------|
| Global Irradiation..... | 4238 kJ |
| Diffuse Portion..... | 55% |
| Degree Days..... | 3886 DD |
| Sunshine..... | 1854 Hrs |
| Average Temperature..... | 7.3°C |
| Relative Humidity..... | 78% |

BUILDING AND LOAD DESCRIPTION

The buildings are oriented to the south. The minimal design temperature is -18°C . The garages are to be maintained at 6°C , the offices at 20°C , the cellars at 15°C , and the workshops at 15°C . Heat losses come to 276 kW, and ventilation losses are 48 kW. The demand for domestic hot water is estimated at 47 kW. The annual energy consumption is calculated to be 341 000 kWh.

The volume of the building is 25 000 cu.m.; its surface area is 8 500 sq.m.

SYSTEM DESIGN

The system consists of a solar panel system, storage system, heat pump system and conventional oil heating system. All buildings are heated by low temperature heat panels. The standby heating is provided by air heaters and radiators. The peak load is carried by the oil heating system.

Storage Subsystem

The earth storage is designed with insulation layers at the top and side walls. The heat exchanger consists of a core in the middle of the storage with horizontal polyethylene pipes in seven layers. The pipes are 20/16 mm diameters, and the layers are separated by a distance of 0.7 meters. The storage volume is 3 500 m^3 , and at the surface it has an area of 31.6 X 31.6 meters. The depth is 7 meters.

Solar Collector Subsystem

The collectors are integrated flat-plate type. The glass cover has a teflon shield. The brutto surface area is 550 sq. meters and the netto surface area is 520 sq. meters.

| | |
|------------------------|---|
| Tilt..... | 38° |
| Type..... | Helionox |
| Intercept..... | 0.66 ± 0.03 Direct Radiation |
| | 0.52 ± 0.03 Diffuse Radiation |
| Slope..... | $3.8 \pm 0.4 \text{ W/m}^2\text{-}^{\circ}\text{C}$ |
| Overall Objective..... | Independence from Oil Use |

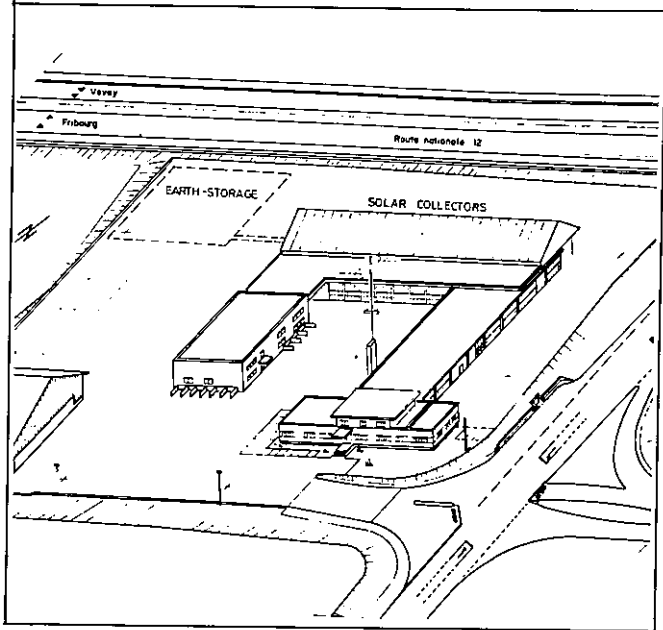

Site Plan

Heat Pump

Water/Water, R12, electrical power supply 44 kW. Heat supply 44 kW.

Heat supply 106 kW, TCOND = 50°C , TEVAP = 7°C , COP = 2.8
161 kW, TCOND = 50°C , TEVAP = 25°C , COP = 3.3

Condenser flow 26 cu.m./hr, evaporation 14 cu.m./hr.

Daily Storage Tank, 3 cu.m.

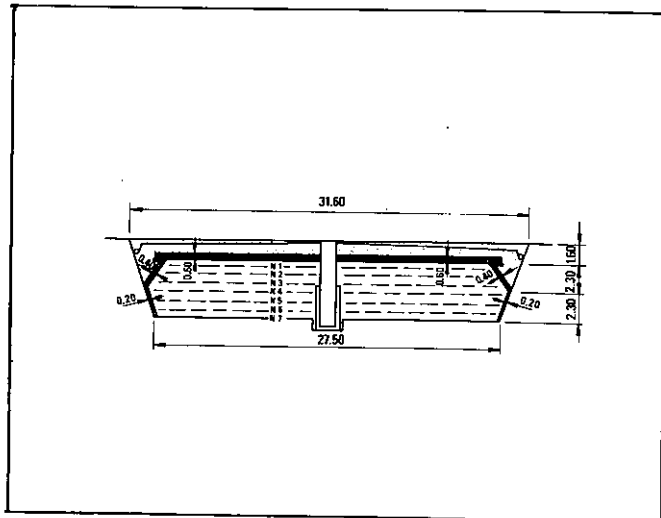

Storage Design

Distribution Subsystem

The solar collector circuit is disconnected from user circuits by a heat exchanger (40% glycol; protection -25°). The solar energy is delivered to the earth storage, the heat pump or directly to the consumers. All circuits can be connected to the common solar manifold. The high temperature manifold is used for ventilation, the air heaters and the radiators. The low temperature manifold is used for the heat panels.

Control System

The strategy is based on maximum temperatures (power). There is a separate subsystem for energy generation/demand. The demand is detected through exterior temperature.

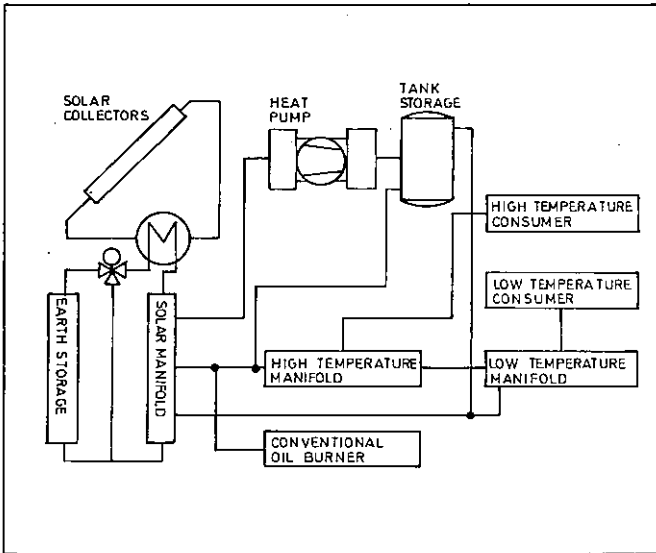

System Diagram

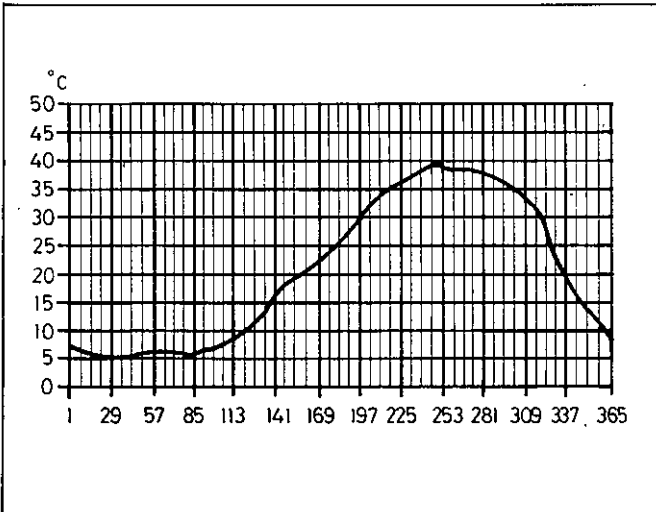

Storage Temperature

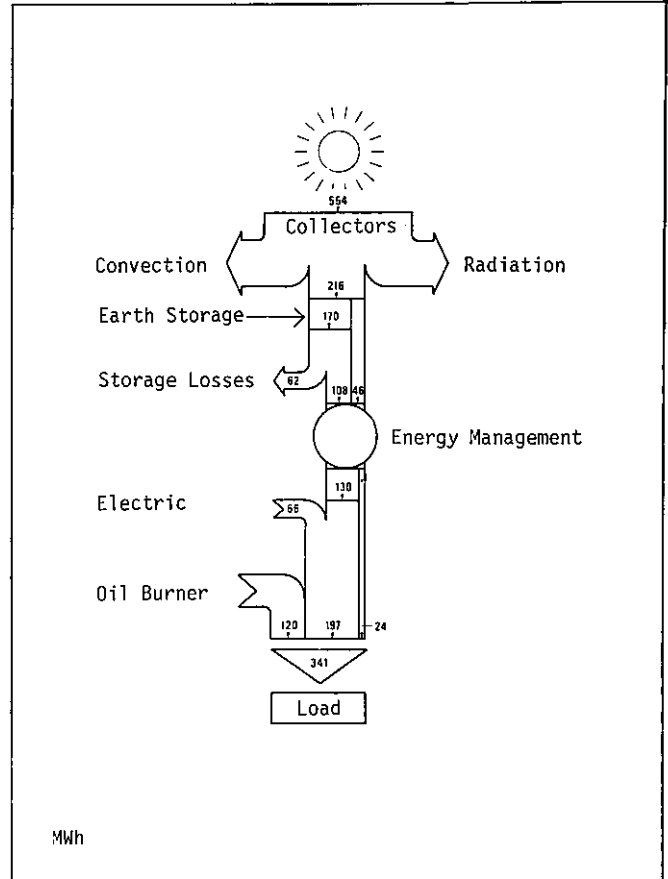

Energy Flow

PERFORMANCE

| | |
|-------------------------------------|-------------|
| Global Solar Radiation..... | MWh 554 |
| Solar Energy Converted..... | 216 |
| Solar Energy Provided Directly..... | 46 |
| Stored Energy..... | 170 |
| Losses of Stored Energy..... | 62 |
| Provided from Store..... | 108 |
| Energy to Heat Pump..... | 130 |
| Energy from Heat Pump..... | 197 |
| Energy from Oil Heating..... | 120 |
| Total Consumption..... | MWh 341 |

CONCLUSIONS

The solar plant is complex. The use of two separate energy levels at low temperature and high temperature allow the efficient use of the available energy from the different sources. Energy management and control are based on successive priority for solar, earth storage, heat pump and finally oil heating.

The buildings designed for low energy consumption (insulation) do make use of passive solar energy.

UNITED KINGDOM

PROJECT DESCRIPTION

The objective of this project was to determine the technical feasibility and cost effectiveness of solar energy systems with seasonal storage in UK conditions. The design has been kept as site independent as possible so that the conclusions are generally applicable to the UK. The performance calculations are based on measured hourly solar radiation and ambient temperatures. The houses are typical of current UK construction and the solar energy system is designed to meet most of the space heating and hot water load.

CLIMATE

| | |
|--------------------------------------|---------|
| Degree Days (15.5°C base) | 2150 |
| Design Ambient Temperature (Heating) | -1°C |
| Mean Day Temperature (Jan) | 4°C |
| Mean Day Temperature (July) | 18°C |
| Solar Radiation (Annual) | 950 kWh |

BUILDING AND LOAD DESCRIPTION

The system is designed to supply the heating and hot water requirements for 100 houses of mixed size having a total floor area of 8000 square metres.

| | |
|--------------------|---------|
| Space Heating Load | 530 MWh |
| Hot Water Load | 380 MWh |

SYSTEM DIAGRAM

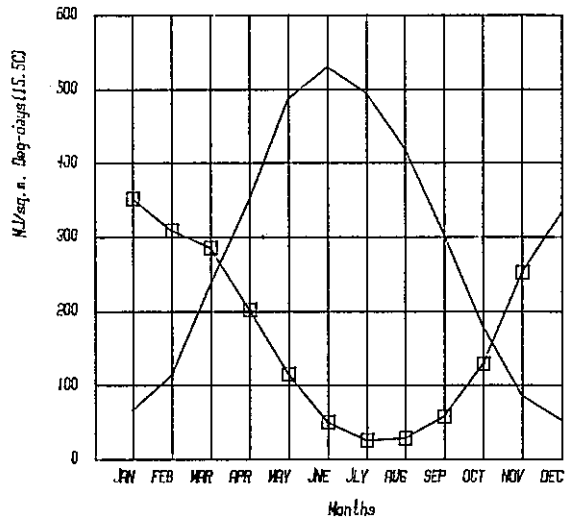
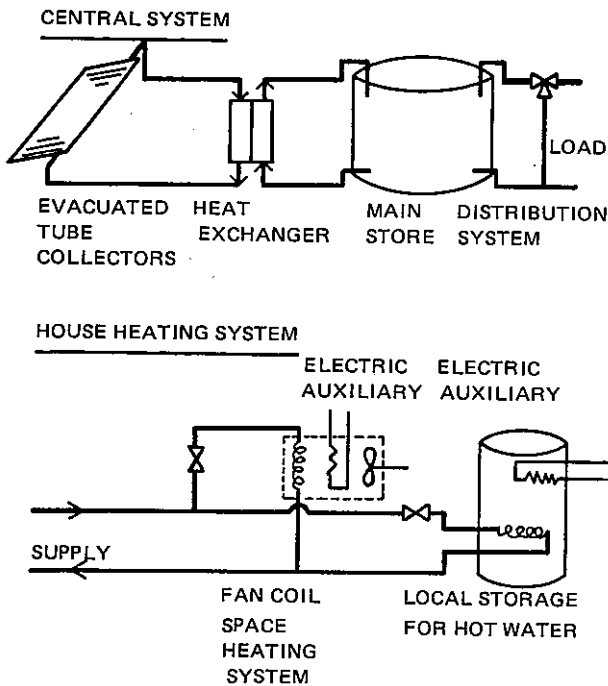

UK solar radiation and degree days

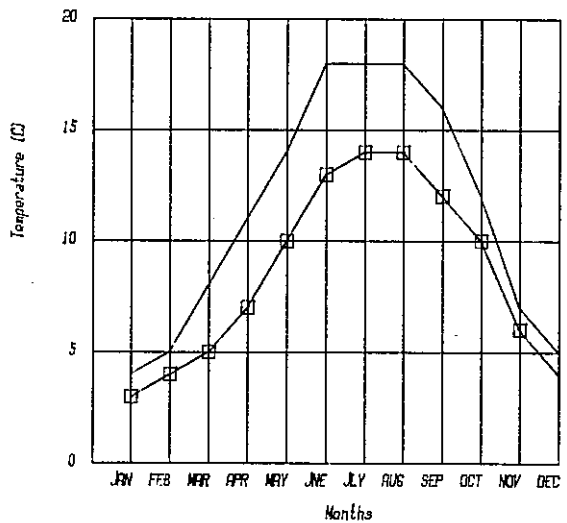

UK mean day and night temperatures

SYSTEM DESIGN

To make the most effective use of the solar energy and to reduce distribution losses, the auxiliary heaters are situated in each house with local DHW storage tanks. House space heating systems use fan coil units to reduce the supply temperature required to meet the load. A parallel auxiliary electrical heater is controlled by a two storage room thermostat. DHW auxiliary heating is by electric immersion heater.

Storage Subsystem

An insulated steel tank is used. It is situated above ground with a volume of 7500 cubic metres. The temperature range is 25 - 80°C.

Solar Collector Subsystem

Evacuated tube collectors are used and are inclined at 30° to the horizontal for minimum shading and maximum summer performance; very little energy is collected in the winter months. Collector array area is 3600 square metres.

RESULTS

The performance predictions are based on meteorological data for the year October 1964 to September 1965 which is a standard (CIBS) UK reference year. Detailed modelling of the houses ensured realistic heating load values for each hour of the heating system. The IEA program MINSUN was used for economic analysis of the system and the Faber program ICARUS was used for detailed system performance predictions. System optimisation depends on many different parameters and the optimum point is particularly sensitive to collector and store subsystem costs and real fuel inflation rate.

PERFORMANCE DATA

Storage

| | |
|-----------------------------|---------|
| Maximum temperature | 80° C |
| Minimum temperature | 25° C |
| Energy stored (25 to 80° C) | 481 MWh |

Collectors

| | |
|-----------------------------------|-------|
| Mean annual operating temperature | 50° C |
|-----------------------------------|-------|

Percent Solar 84

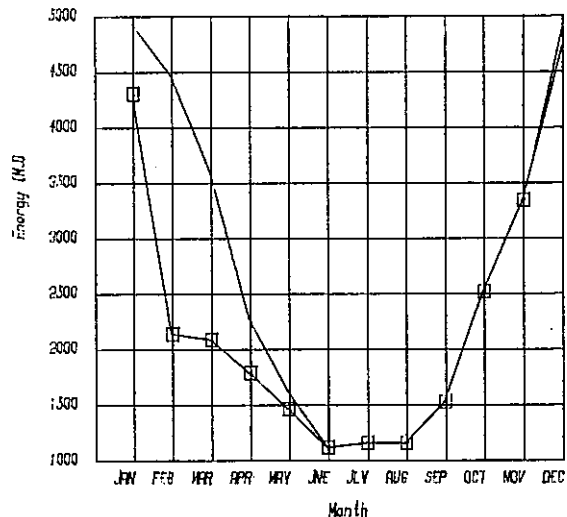

Total load and solar contribution

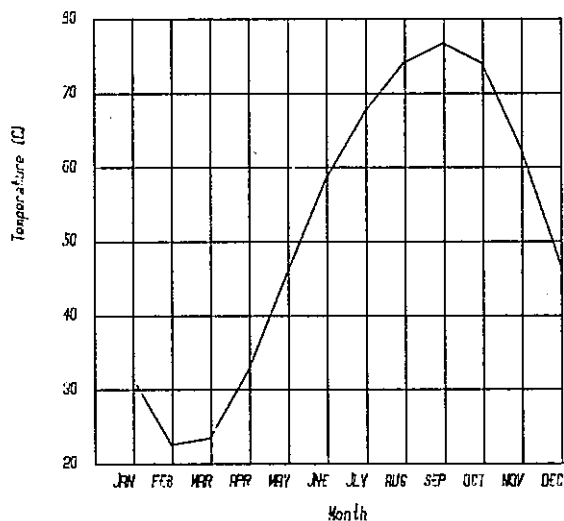

Annual temperature profile for store

CONCLUSIONS

Performance predictions using MINSUN and the Faber simulation program, ICARUS, show that the system is able to supply a high proportion of the load but the economic analysis is not so encouraging. The analysis shows that an increase in fuel costs and a reduction in the cost of storage would result in such systems being cost effective.

UNITED STATES

PROJECT DESCRIPTION

The solar seasonal storage site is in Boston, Massachusetts (latitude = 42.37) in the completed National Historic Park portion of the Charlestown Navy Yard which is currently undergoing a major redevelopment. The Park is open year round to the public and is a major tourist attraction. The system makes use of two large, underground storage tanks built in the 1950's for the Navy Yard. The central solar system provides district heating for five buildings around the tanks used for residential, administrative, and public purposes. Area for collector placement is constrained but available on flat roofs of nearby buildings. A heatpump is used to increase the useful storage capacity and improve collector performance.

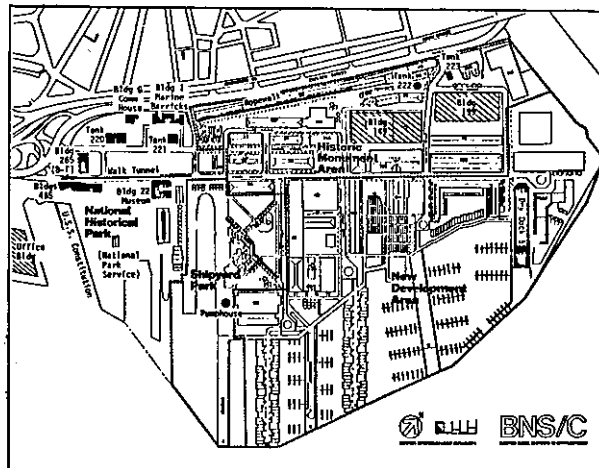
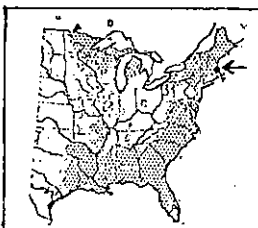

CLIMATE

Insolation on a normal surface, annual.....1341 kWh/m²
 Insolation on a horizontal surface, annual.....1268 kWh/m²
 Insolation on a horizontal surface, daily, Dec....1.5 kWh/m²
 Insolation on a horizontal surface, daily, June....6.0 kWh/m²
 Mean ambient temperature, heating season.....3.1°C
 Design temperature (peak), heating.....60°C
 Number of Degree Days, (based 18°C).....3209

BUILDING AND LOAD DESCRIPTION

The buildings to be heated are old, heavy masonry, historic buildings built as part of the Navy Yard and now owned by the National Park Service. The set of buildings in this system vary in usage. There are approximately 10 apartments and 50 single rooms in residential quarters, a large dining/kitchen facility, an administrative office building, a museum, and a large house open for special functions. These buildings and others are connected by piping tunnels, so that the load may be readily varied.

The annual load anticipated in 2000 MWh space heat and 19.1 kW (167 MWh/yr) hot water demand. The heat is delivered at 55°C and an indoor temperature of 18°C was assumed.

SYSTEM DESIGN

The present design calls for a system with 2300 m² flat plate collectors, storage in two underground concrete tanks containing 5700 m³, and a heatpump. This design meets 50% of the load.

Storage Subsystem

The solar project makes use of the two large underground concrete tanks built in the 1950s for petroleum and water storage for the Navy Yard. The tanks are presently not used, but appear to be in good condition. The tanks are about 5 m in height and constructed of 50 cm thick concrete walls with the top surface about 1 meter below ground level. Renovation will require cleaning, inspection, internal insulation, and a liner. A total cost of \$216,000 was calculated for storage renovation.

Site Plan

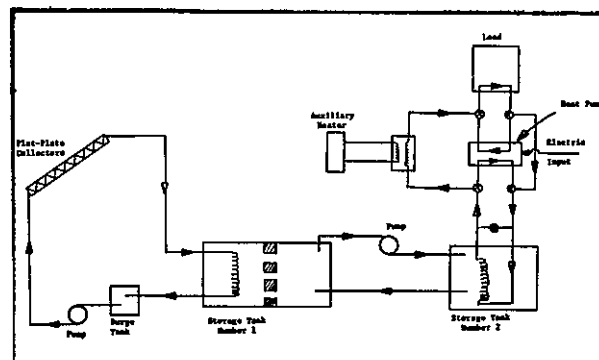

System Design Schematic

Solar Collector Subsystem

System design considered three collector alternatives at assumed 1985 costs - flat plate (245 \$/m²), compound parabolic concentrators (CPC) (370 \$/m²), and parabolic troughs (400 \$/m²). The collectors will be located either on the flat roof of a two story building just outside the park, or on a large ten story Navy Yard building approximately 1200 m away, which is to be redeveloped.

Heat Pump

The system was analyzed with and without a heat pump. The heat pump is used to meet the load when storage temperature drops below 55°C. Storage temperature is reduced to around 10°C. The 366 kW heatpump operates at an annual C.O.P. of 3.6.

RESULTS

The system alternatives were analyzed using MINSUN III and a MINREP driving program to provide repetitive single point runs with specified changes in parameters. System performance and economics were carefully considered.

Without the heatpump the storage temperature ranges between 45°C and 97°C, and CPC and parabolic collectors provided much better performance than flat plates, even though much collected heat had to be discarded after maximum storage temperature was attained in late July. The heatpump extended the storage temperature range down to 10°C and provided better collector performance and solar fraction and a substantially reduced system costs for all collector types. Flat plate collectors showed the greatest benefit from the heat pump so that their performance was comparable to the concentrators. Given their lower cost, flat plates became the design choice.

Solar Cost (\$/MWH) was defined as the annualized system capital cost plus the annualized heat pump operational cost, divided by the solar and heat pump energy supplied to the load. The flat plate system with heat pump provided the lowest solar cost and is competitive with conventional heating at a fuel cost of 0.05 \$/kWh, a real fuel escalation rate of 3.5% and a real discount rate of 4%.

Design system performance shows the storage meeting the space heating load unassisted from October to mid-November. The heat pump is then used solely thru mid-December. The remainder of the heating season is met with a combination of the heat pump and the auxiliary/conventional system. At the reduced storage temperatures produced by the heat pump, solar energy collection remains efficient year round and system heat losses are reduced.

CONCLUSIONS

The Charlestown Navy Yard system is attractive due to the existing storage tanks and piping tunnels, and the public accessibility to the site. Analysis indicated a substantial performance and economic benefit (especially for flat plate collectors) provided by including a heat pump. A flat plate collector array of 2300 m² provides a solar fraction of 50% for the 2167 MWH annual load. The cost of the solar energy produced is competitive with the conventional heating means assumed.

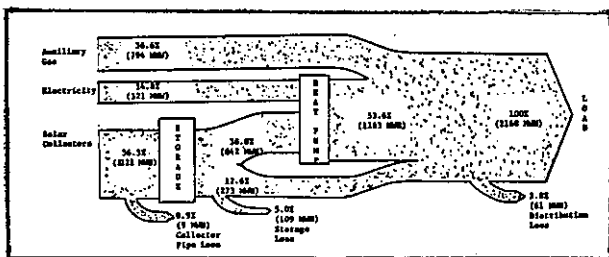

Energy Flow

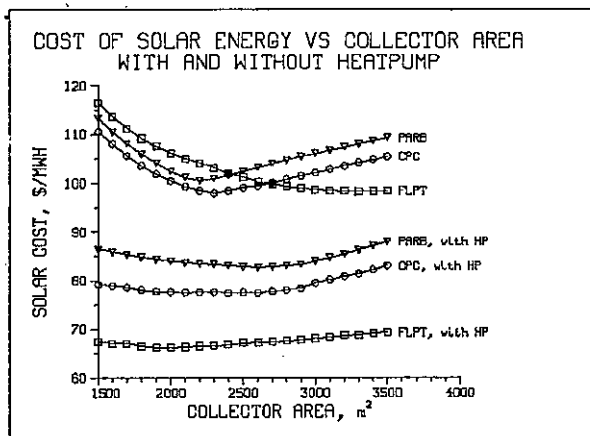
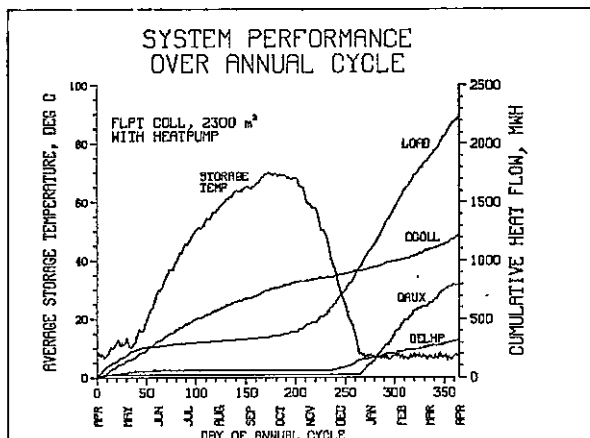
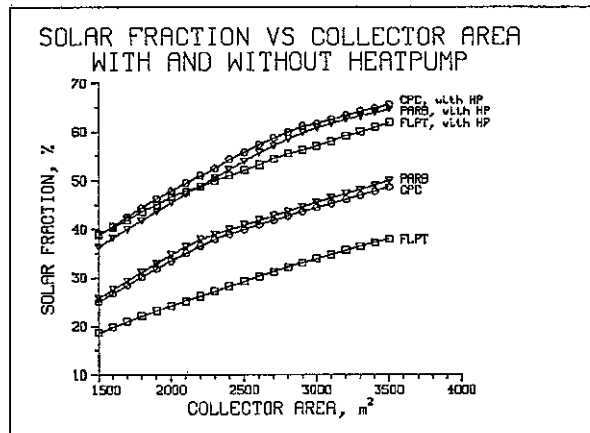

REFERENCES

APPENDIX 1

IEA Technical Reports

- (1) Bruce, T. & Lindeberg, L., 1982, Central Solar Heating Plants with Seasonal Storage - Basic Design Data for the Heat Distribution System, Swedish Council for Building Research, Document D 22:1982, Stockholm, Sweden.
- (2) Chuard, P. & Hadorn, J-C., 1983, Central Solar Heating Plants with Seasonal Storage - Heat Storage Systems: Concepts, Engineering Data and Compilation of Projects, Office central fédéral des imprimés et du matériel, Berne, Switzerland.
- (3) Hadorn, J-C. & Chuard, P., 1983, Central Solar Heating Plants with Seasonal Storage - Cost Data and Cost Equations for Heat Storage Concepts, Office central fédéral des imprimés et du matériel, Berne, Switzerland.
- (4) Hadorn, J-C. & Chuard, P., 1983, Central Solar Heating Plants with Seasonal Storage - Heat Storage Models - Evaluation & Selection, Office central fédéral des imprimés et du matériel, Berne Switzerland.
- (5) Bankston, C., 1984, Central Solar Heating Plants with Seasonal Storage - Basic Performance, Cost, and Operation Information for the Solar Collectors, Argonne National Laboratories, Argonne, U.S.A.
- (6) Chant, V. & Biggs, R., 1983, Central Solar Heating Plants with Seasonal Storage, Tools for Design and Analysis, National Research Council, Document CENSOL1, Ottawa, Canada.
- (7) Chant, V. & Håkansson, R., 1983, Central Solar Heating Plants with Seasonal Storage - The MINSUN Simulation and Optimization Program - Application and User's Guide, National Research Council, Document CENSOL2, Ottawa, Canada.

Task Working Paper

- (8) National Report - Chapter 6 - Economics, Discussion paper 18 at Experts Meeting nr 5, Hidemark Danielson Ark., Stockholm, Sweden. (Not published).

National Design Studies

- | <u>Author and Title</u> | <u>To be ordered from</u> |
|---|--|
| (9) M.Bruck et al., Mai 1983, Alternative-Energy-Project, Innsbruck-Kranebitten Austrian Institute for Building Research | Austrian Institute for Building Research A - 1190 WIEN An den langen Lüssen 1/6 |
| (10) V. Chant et al., 1983, Feasibility Analysis of Solar Energy Storage in an Aquifer, Public Works Canada, Ottawa, Canada | Edward L Morofsky Public Works Canada Energy Secretariat Sir Charles Tupper Bldg C417 OTTAWA, ONTARIO, K1A 0M2 CANADA |
| (11) D. Van Hattem, Design Study for a Solar Heated High School Centre in Northern Italy | Dolf van Hattem CEC Joint Research Centre I-21020 ISPRA Italy |
| (12) M. Dytzak et al., 1983, Technic-economic evaluation of the CSH PSS with heat pump for the Hjortekaer settlement: Simulation Studies. Report 83-2, The Thermal Insulation Laboratory | The Thermal Insulation Laboratory Technical University Building 118 DK - 2800 LYNGBY Denmark |
| (13) G. Bergmann et al., Systemstudie zur Nutzung der Sonnenergie für die zentrale Wärmeversorgung von Gebäude- komplexen, Projekt-Nr. 03E-4453-A, Final Report | Fachinformationszentrum KARLSRUHE D - 7514 Eggenstein - Leopoldshafen 2 Federal Republic of Germany |
| (14) J. Strickrodt, W. Breuer, Langzeitwärmespeicher Prototyp Wolfsburg, Projekt-Nr. 03E-5274-A, Final Report | Fachinformationszentrum KARLSRUHE D - 7514 Eggenstein - Leopoldshafen 2 Federal Republic of Germany |

- | <u>Author and Title</u> | <u>To be ordered from</u> |
|--|---|
| (15) June 1983, Groningen: A group of 96 solar houses with seasonal heat storage in the soil, Final report for IEA, Task VII, Subtask I(e), report number 103.220 | Institute of Applied Physics Heat Department P.O. Box 155 2600 AD DELFT The Netherlands |
| (16) T. Bruce et al., 1983, Södertuna - The Solar Heated Community, Document D8:1985, Swedish Council for Building Research, Stockholm | AB Svensk Byggtjänst Box 7853 S - 103 99 STOCKHOLM Sweden |
| (17) P. Chuard et al., Oct 1983, Central Solar Heating Plants with Seasonal Storage - The Vaulruz Project, Swiss Contribution to IEA Task VII - Subtask I(e), Swiss Federal Office of Energy & Swiss National Foundation for Energy Research | Mr J.C. Hadorn SORANE SA Route du Chatelard 52 CH - 1018 LAUSANNE Switzerland |
| (18) June 1983, U K Final Report IEA Solar Task VII, Phase I, Report RLF/9907, Oscar Faber & Partners | Mr R. LaFontaine Oscar Faber & Partners Upper Marlborough Road S:T ALBANS Herts AL1 3UT United Kingdom |
| (19) D. Breger, 1982, A Solar District Heating System Using Seasonal Storage for the Charlestown, Boston Navy Yard Redevelopment Project, ANL-82-90, Argonne National Laboratory, U.S.A. | National Technical Information Services 5285 Port Royal Road SPRINGFIELD, VA., 22161 U.S.A. |
| (20) D. Breger et al., 1983, A Seasonal Storage Solar Energy Heating System for the Charles- town, Boston Navy Yard National Historic Park: Phase II, Analysis with Heat Pump, ANL-83-58, Argonne National Laboratory, U.S.A. | National Technical Information Services 5285 Port Royal Road SPRINGFIELD, VA., 22161 U.S.A. |



LIST OF PARTICIPATING EXPERTS

APPENDIX 2

Manfred Bruck
Austrian Solar and Space Agency
Garnisongasse 7
A-1080 WIEN
AUSTRIA

Edward Morofsky
Public Works Canada
Energy Secretariat
Sir Charles Tupper Bldg. C456
OTTAWA, ONTARIO, K1A 0M2
CANADA

Gottfried Schaffar
TU-Wien
Inst. für Allgem. Physik
Karlsplatz 13
A-1040 WIEN
AUSTRIA

Dolf van Hattem
Commission of the European
Communities
Joint Research Center
I-21020 ISPRA
ITALY

Günter Spielmann
Austrian Institute for
Building Research
An den langen Lüssen 116
A-1190 WIEN
AUSTRIA

Kurt K. Hansen
Thermal Insulation Lab.
Building 118
Technical University Denmark
DK-2800 LYNGBY
DENMARK

Alfred Sigmund
Austrian Institute for
Building Research
An den langen Lüssen 116
A-1190 WIEN
AUSTRIA

Preben N. Hansen
Thermal Insulation Lab.
Building 118
Technical University Denmark
DK-2800 LYNGBY
DENMARK

Ronald C. Biggs
Division of Building Research
National Research Council
Montreal Road (M-24)
OTTAWA, ONTARIO, K1A 0R6
CANADA

Cees den Ouden
Institute of Applied Physics
TNO/TH
P O Box 155
2600 AD DELFT
The NETHERLANDS

Verne G. Chant
Hickling-Partners Inc.
Suite 605/350 Sparks Street
OTTAWA, ONTARIO, K1R 7S8
CANADA

Volkmar Lottner
Kernforschungsanl. Jülich GmbH
Postfach 1913
5170 JÜLICH
FEDERAL REPUBLIC OF GERMANY

Tom LeFeuvre
Division of Energy
National Research Council
Montreal Road (M-92)
OTTAWA, ONTARIO, K1A 0R6
CANADA

Heinz Riemer
Kernforschungsanl. Jülich GmbH
Postfach 1913
STE
5170 JÜLICH
FEDERAL REPUBLIC OF GERMANY

Franz Scholz
KFA Jülich
Postfach 1913
5170 JÜLICH
FEDERAL REPUBLIC OF GERMANY

Jan Nilsson
Riksbyggen
Box 6709
S-113 85 STOCKHOLM
SWEDEN

Aad Wijsman
Technisch Physische Dienst
TNO/TH
P O Box 155
2600 AD DELFT
The NETHERLANDS

Heimo Zinko
Studsvik Energiteknik AB
S-611 82 NYKÖPING
SWEDEN

Arne Boysen
B Hidemark G Danielson
Arkitektkontor HB
Järntorget 78
S-111 29 STOCKHOLM
SWEDEN

Elisabeth Kjellsson
Uppsala Kraftvärme AB
Box 125
S-751 04 UPPSALA
SWEDEN

Tomas Bruce
Södertälje Energiverk
S-151 89 SÖDERTÄLJE
SWEDEN

Pierre Chuard
Sorane S A
Rte du Chatelard 52
CH-1018 LAUSANNE
SWITZERLAND

Göran Hellström
University of Lund
Dept. of Mathematical Physics
Box 725
S-220 07 LUND
SWEDEN

John van Gilst
Sorane S A
Rte du Chatelard 52
CH-1018 LAUSANNE
SWITZERLAND

Rune Håkansson
Studsvik Energiteknik AB
611 82 NYKÖPING
SWEDEN

J C Hadorn
Sorane S A
Rte du Chatelard 52
CH-1018 LAUSANNE
SWITZERLAND

Per-Olov Karlsson
Statens Vattenfallsverk
Konstruktion och byggande
S-162 87 VÄLLINGBY
SWEDEN

Barry Alper
ETSU
Building 156
DIDCOT, OXFORDSHIRE OX 11
ORA
UNITED KINGDOM

Robin LaFontaine
Oscar Faber and Partners
Marlborough House
Upper Marlborough Road
St ALBANS HERTS, AL1 3UT
UNITED KINGDOM

Brian Rogers
Department of Mechanical
Engineering & Energy Studies
University College
Newport Road
CARDIFF, DF2 1TA
UNITED KINGDOM

Charles A Bankston
2861 Arizona Terrace, N.W.
WASHINGTON, D.C. 20016
U.S.A.

Landis Kannberg
Underground Energy
Storage Program
Batelle Pacific
Northwest Labs.
P.O. Box 999
RICHLAND, W.A. 99352
U.S.A.

Allan I Michaels
Solar Thermal Storage Program
Argonne National Lab.
9700 South Cass Ave.
Building 362
ARGONNE, ILLINOIS 60439
U.S.A.

Dwayne Breger
Solar Thermal Storage Program
23 Aldie Street
ALLSTON, MASSACHUSETTS 02134
U.S.A.

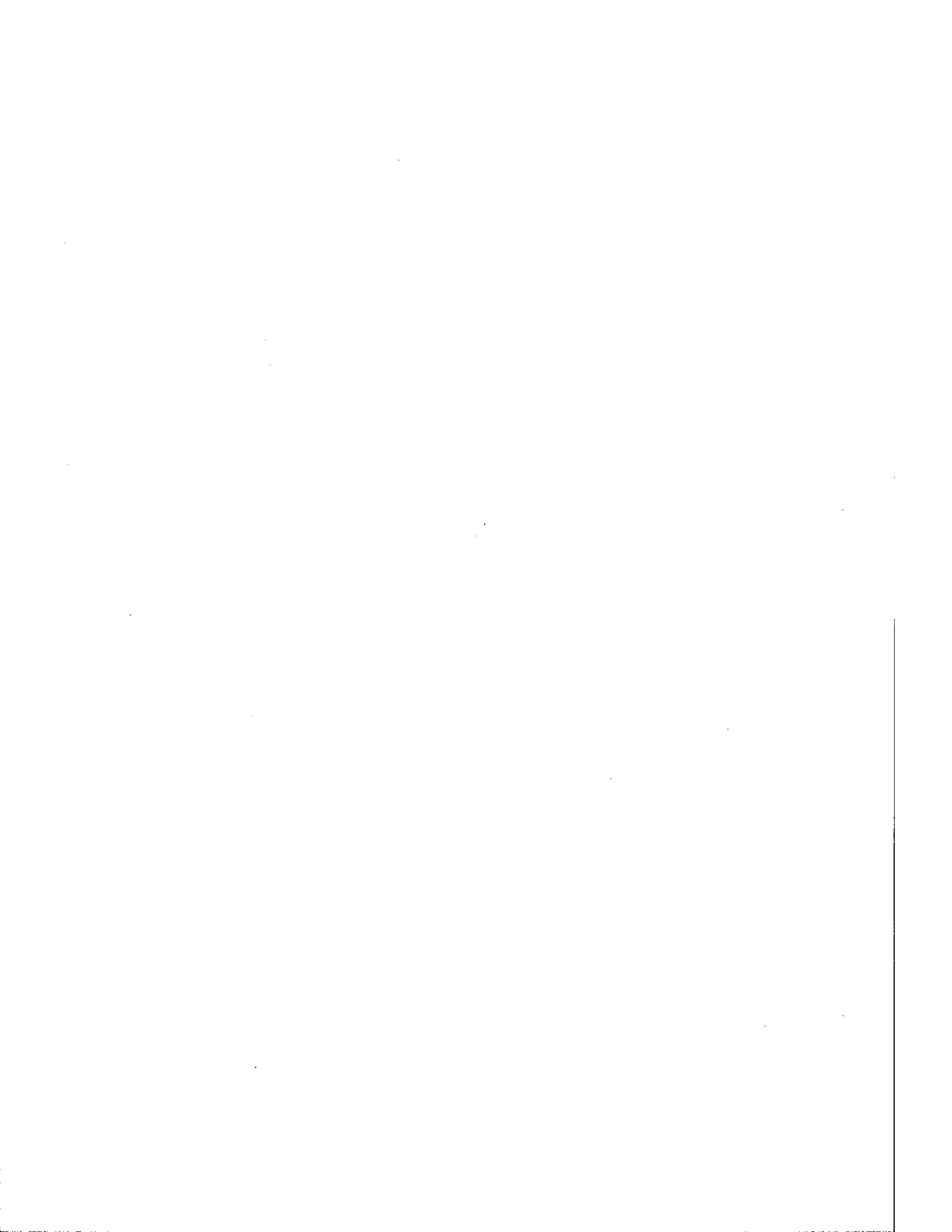

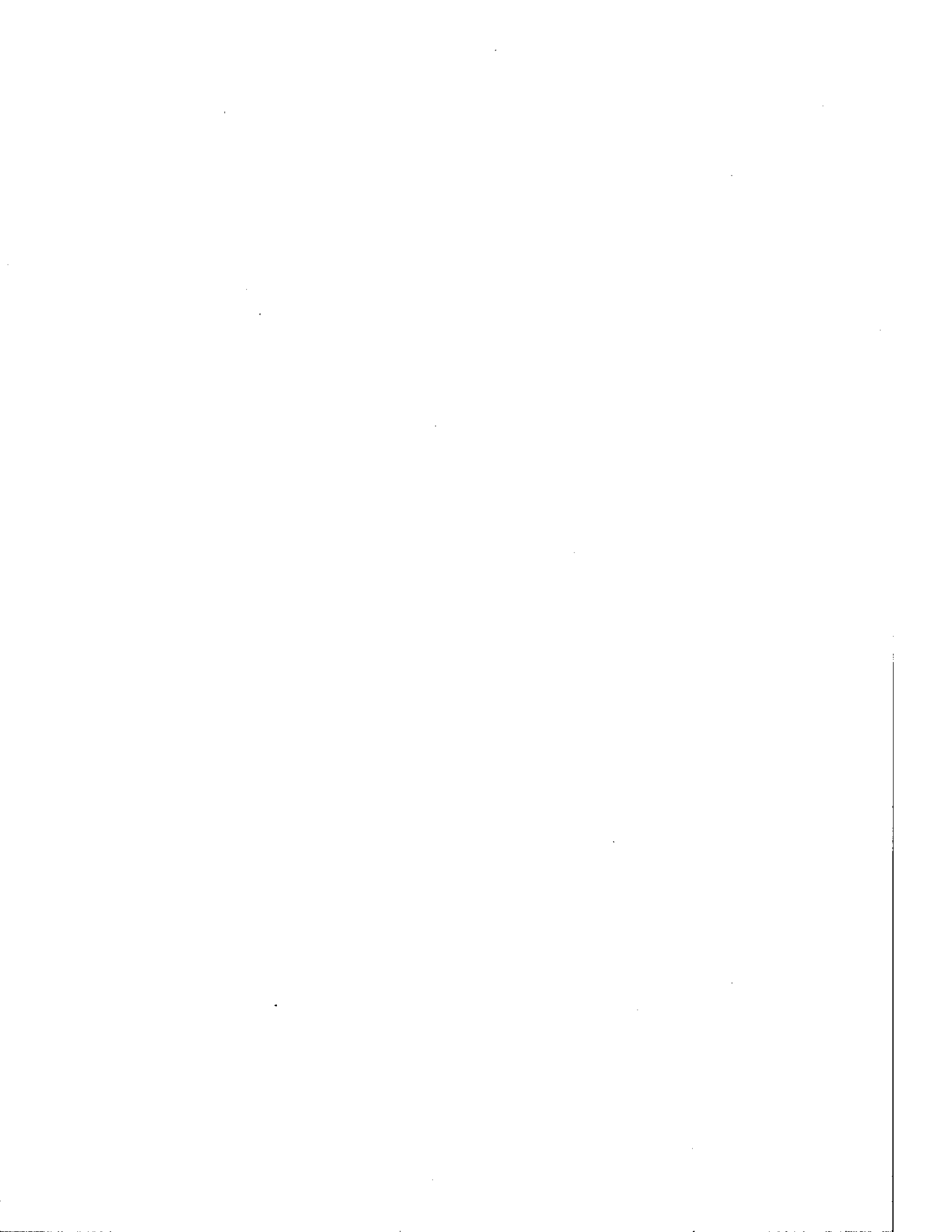

Stockholm 1985 05 07

To the members of the
Executive Committee for the
IEA Solar Heating and Cooling Program

Report from Task VII, Subtask I(e):

Please find enclosed your copies of the report "Preliminary Designs for Ten Countries", issued by the Swedish Council for Building Research as Document D12:1985. If you want more copies they can be ordered from Svensk Byggtjänst, Box 7853, S-103 99 Stockholm.

Yours sincerely



Arne Boysen

Operating Agent Task VII

Encl.: D12:1985

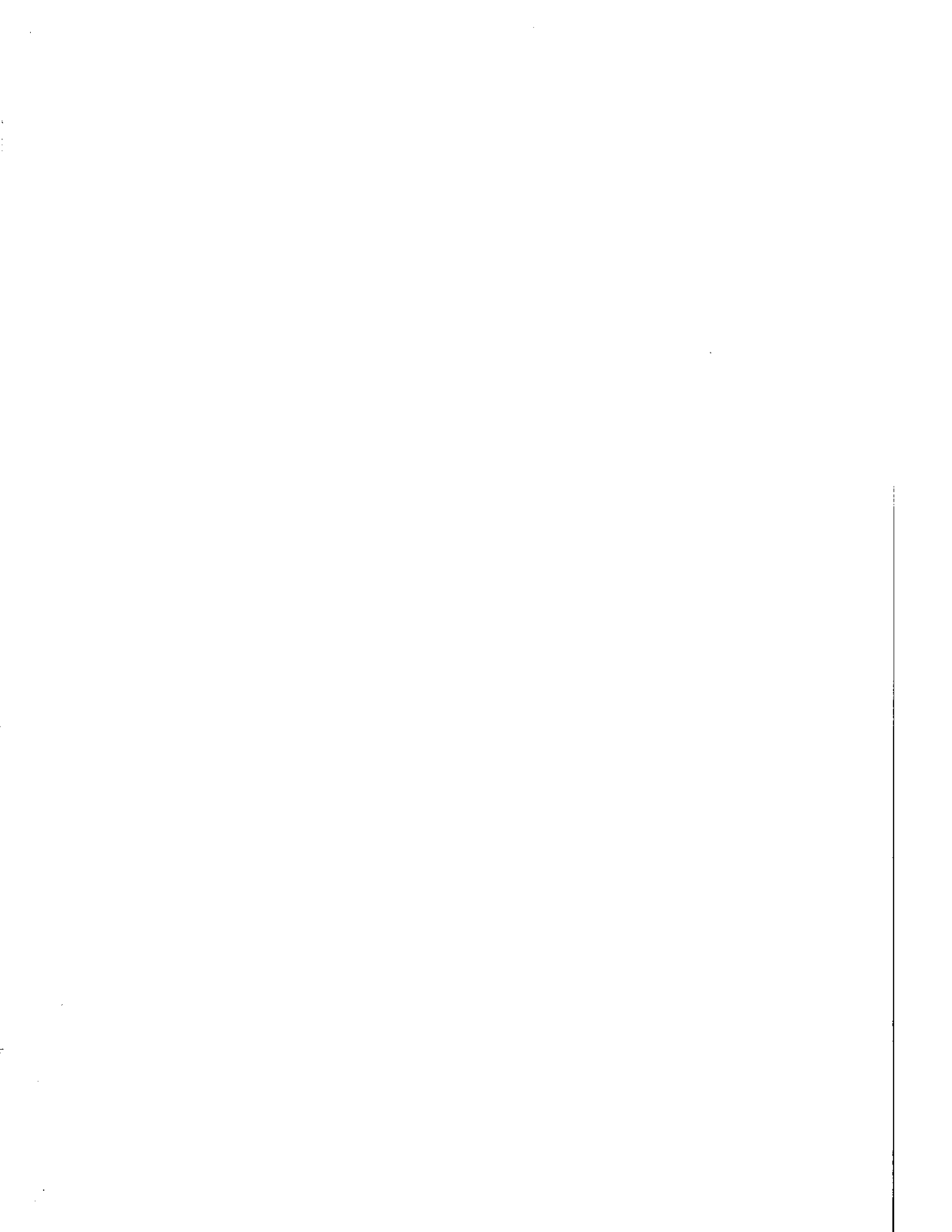

The purpose of Task VII - Central Solar Heating Plants with Seasonal Storage - is to investigate the feasibility and the cost-effectiveness of large systems with a capacity for storing solar energy from summer to be used in winter.

This report gives an overview of the work in the first Phase of the Task, with references to IEA Technical Reports as well as national reports. A description is made of the MINSUN computer program which has been developed to be used for optimization of a design. Ten different designs are presented with basic data. They represent ideas, and in some cases real projects, from:

AUSTRIA
CANADA
CEC Joint Research Centre, ISPRA
DENMARK
FEDERAL REPUBLIC OF
GERMANY

NETHERLANDS
SWEDEN
SWITZERLAND
UNITED KINGDOM
UNITED STATES OF
AMERICA

Document D12:1985
ISBN 91-540-4371-9

Swedish Council for Building Research,
Stockholm, Sweden

Art.No: 6702512
Distribution: unrestricted
Additional copies can be ordered from:
Svensk Byggtjänst, Box 7853
S-103 99 Stockholm, Sweden
Approx.price: SEK 45